

SimBiology[®]

User's Guide



MATLAB[®]

R2022a



How to Contact MathWorks



Latest news: www.mathworks.com
Sales and services: www.mathworks.com/sales_and_services
User community: www.mathworks.com/matlabcentral
Technical support: www.mathworks.com/support/contact_us



Phone: 508-647-7000



The MathWorks, Inc.
1 Apple Hill Drive
Natick, MA 01760-2098

SimBiology[®] *User's Guide*

© COPYRIGHT 2005–2022 by The MathWorks, Inc.

The software described in this document is furnished under a license agreement. The software may be used or copied only under the terms of the license agreement. No part of this manual may be photocopied or reproduced in any form without prior written consent from The MathWorks, Inc.

FEDERAL ACQUISITION: This provision applies to all acquisitions of the Program and Documentation by, for, or through the federal government of the United States. By accepting delivery of the Program or Documentation, the government hereby agrees that this software or documentation qualifies as commercial computer software or commercial computer software documentation as such terms are used or defined in FAR 12.212, DFARS Part 227.72, and DFARS 252.227-7014. Accordingly, the terms and conditions of this Agreement and only those rights specified in this Agreement, shall pertain to and govern the use, modification, reproduction, release, performance, display, and disclosure of the Program and Documentation by the federal government (or other entity acquiring for or through the federal government) and shall supersede any conflicting contractual terms or conditions. If this License fails to meet the government's needs or is inconsistent in any respect with federal procurement law, the government agrees to return the Program and Documentation, unused, to The MathWorks, Inc.

Trademarks

MATLAB and Simulink are registered trademarks of The MathWorks, Inc. See www.mathworks.com/trademarks for a list of additional trademarks. Other product or brand names may be trademarks or registered trademarks of their respective holders.

Patents

MathWorks products are protected by one or more U.S. patents. Please see www.mathworks.com/patents for more information.

Revision History

September 2005	Online only	New for Version 1.0 (Release 14SP3+)
March 2006	Online only	Updated for Version 1.0.1 (Release 2006a)
May 2006	Online only	Updated for Version 2.0 (Release 2006a+)
September 2006	Online only	Updated for Version 2.0.1 (Release 2006b)
March 2007	Online only	Rereleased for Version 2.1.1 (Release 2007a)
September 2007	Online only	Rereleased for Version 2.1.2 (Release 2007b)
October 2007	Online only	Updated for Version 2.2 (Release 2007b+)
March 2008	Online only	Updated for Version 2.3 (Release 2008a)
October 2008	Online only	Updated for Version 2.4 (Release 2008b)
March 2009	Online only	Updated for Version 3.0 (Release 2009a)
September 2009	Online only	Updated for Version 3.1 (Release 2009b)
March 2010	Online only	Updated for Version 3.2 (Release 2010a)
September 2010	Online only	Updated for Version 3.3 (Release 2010b)
April 2011	Online only	Updated for Version 3.4 (Release 2011a)
September 2011	Online only	Updated for Version 4.0 (Release 2011b)
March 2012	Online only	Updated for Version 4.1 (Release 2012a)
September 2012	Online only	Updated for Version 4.2 (Release 2012b)
March 2013	Online only	Updated for Version 4.3 (Release 2013a)
September 2013	Online only	Updated for Version 4.3.1 (Release 2013b)
March 2014	Online only	Updated for Version 5.0 (Release 2014a)
October 2014	Online only	Updated for Version 5.1 (Release 2014b)
March 2015	Online only	Updated for Version 5.2 (Release 2015a)
September 2015	Online only	Updated for Version 5.3 (Release 2015b)
March 2016	Online only	Updated for Version 5.4 (Release 2016a)
September 2016	Online only	Updated for Version 5.5 (Release 2016b)
March 2017	Online only	Updated for Version 5.6 (Release 2017a)
September 2017	Online only	Updated for Version 5.7 (Release 2017b)
March 2018	Online only	Updated for Version 5.8 (Release 2018a)
September 2018	Online only	Updated for Version 5.8.1 (Release 2018b)
March 2019	Online only	Updated for Version 5.8.2 (Release 2019a)
September 2019	Online only	Updated for Version 5.9 (Release 2019b)
March 2020	Online only	Updated for Version 5.10 (Release 2020a)
September 2020	Online only	Updated for Version 6.0 (Release 2020b)
March 2021	Online only	Updated for Version 6.1 (Release 2021a)
September 2021	Online only	Updated for Version 6.2 (Release 2021b)
March 2022	Online only	Updated for Version 6.3 (Release 2022a)

Keyboard Shortcuts for SimBiology Model Builder	1-2
Shortcuts for Diagram	1-2
Shortcuts for Browser Tables	1-2
Keyboard Shortcuts for SimBiology Model Analyzer	1-4
Shortcuts for Datasheets and Tables	1-4
Shortcuts for Running Programs	1-4
Shortcuts for Help and Working with Project	1-4
Message Indicator Icons in SimBiology Model Builder	1-6
Copy SimBiology Blocks	1-7
Compartment Blocks	1-7
Species Blocks	1-7
Reaction Blocks	1-7
Parameter Blocks	1-7
Rule Blocks	1-7
SimBiology Model Component Libraries	1-9
Create Model of Receptor-Ligand Kinetics	1-11
Open Model Builder App	1-11
Build Model	1-11
Simulate Model	1-13
Incorporate SGLT2 Inhibition into Physiologically Based Glucose-Insulin Model Using SimBiology Model Builder	1-16
Glucose-Insulin Model	1-16
Sodium-Glucose Cotransporter-2 (SGLT2) Inhibition	1-16
Incorporate Inhibitor PK by Adding and Configuring Reactions	1-16
Incorporate Inhibitor PD Using Mathematical Equation	1-21
Update Renal Excretion Reaction to Incorporate Presence of Inhibitor Compound	1-22
Incorporate Sudden Changes in Model Behavior Using Event	1-24
Add Doses	1-26
Represent Biological Variability Using Variants	1-28
Show Model Equations and Initial Conditions	1-31
Define Observable Expressions	1-33
Visualize Model Behavior Using Model Simulation Tool	1-35
Export Model	1-39
Find Important Parameters with Local Sensitivity Analysis Using SimBiology Model Analyzer App	1-41
Tumor Growth Model	1-41

Sensitivity Analysis	1-42
Calculate Sensitivities	1-42
Model Biological Variability with Virtual Patients Using SimBiology	
Model Analyzer App	1-61
Tumor Growth Model	1-61
Description of Virtual Population	1-62
Dosing Strategies	1-63
Generate Samples to Represent Virtual Patients	1-63
Perform Monte Carlo Simulations	1-68
Postprocess Simulation Data	1-73
Calculate NCA Parameters and Fit Model to PK/PD Data Using	
SimBiology Model Analyzer App	1-77
Tumor Growth Model	1-77
PK/PD Data Description	1-78
Load Tumor Growth Model and Data	1-79
Visualize Experimental Data	1-79
Perform Noncompartmental Analysis (NCA)	1-82
Estimate Model Parameters Using Nonlinear Regression	1-85
Scan Dosing Regimens Using SimBiology Model Analyzer App	1-108
Target-Mediated Drug Disposition (TMDD) Model	1-108
Explore Model Response Using Different Dose Amounts	1-108
Undo and Redo Model Changes in SimBiology	1-119
Model Changes in Model Analyzer App	1-119
Undo Deletion of Model Components	1-119
Actions Not Supported for Undoing or Redoing	1-120
Generate SimBiology Model Report	1-121
Generate Report for SimBiology Program Results	1-122
Check Saved Models and Data of Project	1-123
Percentile Plot	1-126
Display Options	1-126
Percentile Options	1-126
Mean Options	1-127
Calculation of Percentile Curves, Mean, and Other Statistics	1-128
View and Run Program Code Generated by SimBiology Model Analyzer	
.	1-130
Open Bioavailability Project	1-130
Generate Code for Simulation Program	1-130
Export Input Arguments	1-132
Run Program Code and Plot Results	1-132
Simulate Groups Using Doses and Variants from Data Set	1-135
Load Tumor Growth Model and Data	1-135
Simulate Groups Using Doses and Variants from Data Set	1-136
Estimate Parameters Using Same Setup as Group Simulation	1-140
Perform Group Simulation Using Parameter Estimates	1-142

Find Important Parameters with Global Sensitivity Analysis Using SimBiology Model Analyzer	1-146
Load TMDD Model	1-146
Perform Parameter Scan to Assess Model Behavior	1-146
Compute Sobol Indices	1-152
Compute Elementary Effects	1-157
Perform Multiparametric GSA (MPGSA)	1-161
View and Run Generated Code by SimBiology Model Builder	1-167
Load Bioavailability Model	1-167
Generate Code for Updating Model Components and Graphical Block Properties	1-167
Save Generated Code	1-172
Modify Generated Code	1-173
Run Generated Code	1-173
Actions Not Captured	1-175
Import and Export Variants and Doses from Excel to SimBiology Model Builder	1-176
Import Variants from Excel	1-176
Export Variants to Excel	1-178
Create Excel File for Variants	1-179
Import Doses from Excel	1-180
Export Doses to Excel	1-183
Create Excel File for Doses	1-184

Modeling

2

What is a SimBiology Model?	2-2
Model Definition	2-2
Expressions	2-2
Quantities	2-3
Model Hierarchy	2-4
Representing a Model	2-4
Species Object	2-5
How Species Amounts Change During Simulations	2-5
Keeping a Species Amount Unchanged	2-5
Changing a Species Amount with a Reaction or Rule	2-5
Changing a Species Amount with a Rule When Species is Part of a Reaction	2-6
Keeping a Species Amount Unchanged When Species is Part of a Reaction that Adds or Removes Mass	2-7
Definitions and Evaluations of Reactions in SimBiology Models	2-8
Writing Reaction Expressions	2-8
Writing Reaction Rate Expressions Explicitly	2-9
Creating Reaction Rate Expressions Using Kinetic Law Objects	2-9
Examples of Creating Reaction Rates	2-10
How Reaction Rates Are Evaluated	2-11
Viewing Equations for Reactions	2-12

Definitions and Evaluations of Rules in SimBiology Models	2-13
Overview	2-13
Initial Assignment	2-13
Repeated Assignment	2-13
Algebraic Rules	2-14
Repeated Assignment vs. Algebraic Rules	2-14
Rate Rules	2-14
Evaluation Order of Rules	2-15
Conservation of Amounts During Simulation	2-15
Writing Rule Expressions	2-16
Considerations When Imposing Constraints	2-16
Rate Rule Examples	2-16
Events in SimBiology Models	2-22
Overview	2-22
Event Triggers	2-22
Event Functions	2-22
Specifying Event Triggers	2-23
Specifying Event Functions	2-24
Simulation Solvers for Models Containing Events	2-25
How Events Are Evaluated	2-25
Evaluation of Simultaneous Events	2-26
Evaluation of Multiple Event Functions	2-27
When One Event Triggers Another Event	2-27
Cyclical Events	2-27
Using Events to Address Discontinuities in Rule and Reaction Rate Expressions	2-28
Variants in SimBiology Models	2-29
Creating Variants Programmatically	2-29
Creating Variants Graphically	2-29
Doses in SimBiology Models	2-30
Representing Doses	2-30
Creating Doses Programmatically	2-30
Creating Doses Graphically	2-31
Parameterized and Adaptive Doses	2-31
Simulation Solvers for Models Containing Doses	2-32
Simulate Biological Variability of the Yeast G Protein Cycle Using the Wild-Type and Mutant Strains	2-33
Create and Simulate a Model with a Custom Function	2-35
Overview	2-35
Create a Custom Function	2-36
Load the Example Model	2-37
Add the Custom Function to the Example Model	2-37
Define a Rule to Change Parameter Value	2-37
Add an Event to Reset the Solver at a Discontinuity and Simulate the Model	2-37
Component Usage	2-41
Species Usage	2-41
Parameter Usage	2-41
Compartment Usage	2-41

Observable Usage	2-42
Unit and UnitPrefix Usage	2-42
Abstract Kinetic Law Usage	2-42
Evaluation of Model Component Names in Expressions	2-44
Guidelines for Naming Model Components	2-44
Guidelines for Referencing Names in Expressions	2-44
Precedence Rules for Evaluating Quantity Names	2-44
SimBiology Model Matching Policy	2-46
Model Quantities	2-46
Model Expressions	2-46
Doses and Variants	2-46
Determine Differences in Component Properties	2-47
Compare SimBiology Models	2-48
Compare Models Programmatically	2-48
Compare Models Graphically	2-48
Git Integration	2-50

Structural Analysis

3

Model Verification	3-2
What is Model Verification?	3-2
When to Verify a Model	3-2
Verifying That a Model Has No Warnings or Errors	3-2
Model Verification Example	3-3
View Model Equations	3-3
Conserved Moiety Determination	3-4
Introduction to Moiety Conservation	3-4
Algorithms for Conserved Cycle Calculations	3-4
More About	3-5
Determining Conserved Moieties	3-6
Determining the Adjacency Matrix for a Model	3-9
What Is an Adjacency Matrix?	3-9
Retrieving an Adjacency Matrix for a Model	3-9
Determining the Stoichiometry Matrix for a Model	3-11
What Is a Stoichiometry Matrix?	3-11
Retrieving a Stoichiometry Matrix for a Model	3-11
Selecting Absolute Tolerance and Relative Tolerance for Simulation	3-13
Algorithm	3-13
Absolute Tolerance Scaling	3-13
Troubleshooting Simulation Problems	3-15
Tips for Solving Simulation Problems	3-15
How to Change Solver Options and Simulation Options	3-16

Simulate Model of Glucose-Insulin Response with Different Initial Conditions	3-18
Combine Simulation Scenarios in SimBiology	3-23
Cartesian Combination	3-23
Elementwise Combination	3-23

Simulation and Analysis

4

Model Simulation	4-3
Deriving ODEs from Reactions	4-5
Choosing a Simulation Solver	4-7
SUNDIALS Solvers	4-8
Stochastic Solvers	4-9
When to Use Stochastic Solvers	4-9
Model Prerequisites for Simulating with a Stochastic Solver	4-9
What Happens During a Stochastic Simulation?	4-9
Stochastic Simulation Algorithm (SSA)	4-9
Explicit Tau-Leaping Algorithm	4-10
Implicit Tau-Leaping Algorithm	4-10
References	4-11
Ensemble Runs of Stochastic Simulations	4-12
Running Ensemble Simulations	4-12
Configuring Simulation Settings	4-13
Simulate the Yeast Heterotrimeric G Protein Cycle	4-14
Sensitivity Analysis in SimBiology	4-19
Sensitivity Analysis	4-19
Global Sensitivity Analysis (GSA)	4-19
Comparison of GSA Functions	4-20
Local Sensitivity Analysis (LSA)	4-21
Calculate Sensitivities Using sbiosimulate	4-24
Overview	4-24
Load and Configure the Model for Sensitivity Analysis	4-24
Perform Sensitivity Analysis	4-25
Extract and Plot Sensitivity Data	4-25
Perform a Parameter Scan	4-27
Nonlinear Mixed-Effects Modeling	4-29
What Is a Nonlinear Mixed-Effects Model?	4-29
Nonlinear Mixed-Effects Modeling Workflow	4-30
Specify a Covariate Model	4-31

Specify an Error Model	4-33
Maximum Likelihood Estimation	4-33
Obtain the Fitting Status	4-33
Nonlinear Regression	4-35
What is Nonlinear Regression?	4-35
Fitting Options in SimBiology	4-35
Parameter Transformations	4-37
Maximum Likelihood Estimation	4-38
Fitting Workflow for sbiofit	4-40
Supported Methods for Parameter Estimation in SimBiology	4-42
Error Models	4-44
Progress Plot	4-45
Progress Plot for Nonlinear Mixed-Effects Methods	4-45
Progress Plot for Nonlinear Regression Methods	4-46
Fit One-Compartment Model to Individual PK Profile	4-52
Estimate Category-Specific PK Parameters for Multiple Individuals	4-58
Perform Hybrid Optimization Using sbiofit	4-67
Fit a Two-Compartment Model to PK Profiles of Multiple Individuals	4-71
Estimating the Bioavailability of a Drug	4-78
Accelerating Model Simulations and Analyses	4-85
What Is Acceleration?	4-85
When to Accelerate	4-85
Prerequisites for Accelerating Simulations and Analyses	4-85
Accelerate Simulations Programmatically	4-86
Accelerate Simulations using SimBiology Model Analyzer	4-87
Troubleshooting Accelerated Simulations	4-87
Noncompartmental Analysis	4-88
Data	4-88
Dosing	4-88
Calculating NCA Parameters	4-93
Stochastic Simulation of Radioactive Decay	4-95
Stochastic Simulation of the Lotka-Volterra Reactions	4-100
Comparing SSA and Explicit Tau-Leaping Stochastic Solvers	4-105
Deterministic Simulation of a Model Containing a Discontinuity	4-109
Analysis of Stochastic Ensemble Data in SimBiology	4-113
Deploy a SimBiology Model Using SimFunction	4-122

Deploy a SimBiology Exported Model	4-125
Parameter Scanning, Parameter Estimation, and Sensitivity Analysis in the Yeast Heterotrimeric G Protein Cycle	4-127
Finding Conserved Quantities in a Pathway Model	4-145
Modeling the Population Pharmacokinetics of Phenobarbital in Neonates	4-153
Simulating the Glucose-Insulin Response	4-166
PK/PD Modeling and Simulation to Guide Dosing Strategy for Antibiotics	4-183
Fit PK Parameters Using SimBiology Problem-Based Workflow	4-193

Pharmacokinetic Modeling

5

Pharmacokinetic Modeling Functionality	5-2
Overview	5-2
How SimBiology Supports Pharmacokinetic Modeling	5-2
Pharmacokinetic Modeling Examples	5-3
Acknowledgements: Tobramycin Data Set	5-3
Importing Data — Supported Files and Data Types	5-5
Supported Files and Data Types	5-5
Create Data File with SimBiology Definitions	5-5
Support for Importing NONMEM Formatted Files	5-7
Supported Table Column Types in SimBiology Model Analyzer	5-11
Support for Importing Multidimensional SimData to SimBiology Model Analyzer	5-11
Importing Data	5-12
Import Data from Files	5-12
Importing Data from NONMEM-Formatted Files	5-12
Other Resources for Importing Data	5-13
Create Pharmacokinetic Models	5-14
Ways to Create or Import Pharmacokinetic Model	5-14
How SimBiology Models Represent Pharmacokinetic Models	5-14
Dosing Types	5-15
Elimination Types	5-17
Intercompartmental Clearance	5-18
Unit Conversion for Imported Data	5-19
Create a Pharmacokinetic Model Using the Command Line	5-19

A

Define Reaction Rates with Mass Action Kinetics	A-2
Definition of Mass Action Kinetics	A-2
Zero-Order Reactions	A-2
First-Order Reactions	A-3
Second-Order Reactions	A-3
Reversible Mass Action	A-5
Define Reaction Rates with Enzyme Kinetics	A-6
Simple Model for Single Substrate Catalyzed Reactions	A-6
Enzyme Reactions with Differential Rate Equations	A-6
Enzyme Reactions with Mass Action Kinetics	A-7
Enzyme Reactions with Irreversible Henri-Michaelis-Menten Kinetics ...	A-8

Models Used in Examples

B

Minimal Cascade Model for a Mitotic Oscillator	B-2
Goldbeter Model	B-2
SimBiology Model with Rate Rules	B-4
SimBiology Model with Reactions	B-5
References	B-13
Model of the Yeast Heterotrimeric G Protein Cycle	B-14
Background on G Protein Cycles	B-14
Modeling a G Protein Cycle	B-15
References	B-17
Model of M-Phase Control in Xenopus Oocyte Extracts	B-18
M-Phase Control Model	B-18
M-Phase Control Equations	B-19
SimBiology Model with Rate and Algebraic Rules	B-25
SimBiology Model with Reactions and Algebraic Rules	B-29
References	B-41

SimBiology Apps

- “Keyboard Shortcuts for SimBiology Model Builder” on page 1-2
- “Keyboard Shortcuts for SimBiology Model Analyzer” on page 1-4
- “Message Indicator Icons in SimBiology Model Builder” on page 1-6
- “Copy SimBiology Blocks” on page 1-7
- “SimBiology Model Component Libraries” on page 1-9
- “Create Model of Receptor-Ligand Kinetics” on page 1-11
- “Incorporate SGLT2 Inhibition into Physiologically Based Glucose-Insulin Model Using SimBiology Model Builder” on page 1-16
- “Find Important Parameters with Local Sensitivity Analysis Using SimBiology Model Analyzer App” on page 1-41
- “Model Biological Variability with Virtual Patients Using SimBiology Model Analyzer App” on page 1-61
- “Calculate NCA Parameters and Fit Model to PK/PD Data Using SimBiology Model Analyzer App” on page 1-77
- “Scan Dosing Regimens Using SimBiology Model Analyzer App” on page 1-108
- “Undo and Redo Model Changes in SimBiology” on page 1-119
- “Generate SimBiology Model Report” on page 1-121
- “Generate Report for SimBiology Program Results” on page 1-122
- “Percentile Plot” on page 1-126
- “View and Run Program Code Generated by SimBiology Model Analyzer” on page 1-130
- “Simulate Groups Using Doses and Variants from Data Set” on page 1-135
- “Find Important Parameters with Global Sensitivity Analysis Using SimBiology Model Analyzer” on page 1-146
- “View and Run Generated Code by SimBiology Model Builder” on page 1-167
- “Import and Export Variants and Doses from Excel to SimBiology Model Builder” on page 1-176

Keyboard Shortcuts for SimBiology Model Builder

On macOS, use the **command** key instead of **Ctrl**.

Shortcuts for Diagram

Action	Shortcut
Undo	Ctrl + Z
Redo	Ctrl + Shift + Z
Copy block	Ctrl + C
Paste block	Ctrl + V
Delete block	Delete
Select the next clone of a species	Tab
Select the previous clone of a species	Shift + Tab
Move block up by 1 pixel	Up arrow
Move block down by 1 pixel	Down arrow
Move block left by 1 pixel	Left arrow
Move block right by 1 pixel	Right arrow
Zoom in	Ctrl + +
Zoom out	Ctrl + -
Select usages on page 2-41 of a quantity	Alt + Click a quantity block

Shortcuts for Browser Tables

Action	Shortcut
Select all rows	Ctrl + A
Copy a model component	Ctrl + C
Paste a model component	Ctrl + V
Expand all rows	Ctrl + Shift + Right arrow
Collapse all rows	Ctrl + Shift + Left arrow
Expand a row	Ctrl + Right arrow
Collapse a row	Ctrl + Left arrow
On a Variants or Doses tab, jump the focus from the top (variants or doses) table to the first editable field in the next (Content or Properties) section.	Ctrl + J
Add a compartment	Alt + C
Add a parameter	Alt + P
Add a reaction	Alt + R

Action	Shortcut
Add an algebraic rule	Alt + A
Add an event	Alt + E
Add an initial assignment rule	Alt + I
Add a repeated assignment rule	Alt + T
Add a rate rule	Alt + L
Add an observable expression	Alt + O

See Also

More About

- “SimBiology Apps”
- “Create Model of Receptor-Ligand Kinetics” on page 1-11
- “Incorporate SGLT2 Inhibition into Physiologically Based Glucose-Insulin Model Using SimBiology Model Builder” on page 1-16

Keyboard Shortcuts for SimBiology Model Analyzer

On macOS, use the **command** key instead of **Ctrl**.

Shortcuts for Datasheets and Tables

Action	Shortcut
Expand all rows	Ctrl + Shift + Right arrow
Collapse all rows	Ctrl + Shift + Left arrow
Expand a row	Ctrl + Right arrow
Collapse a row	Ctrl + Left arrow
Select all	Ctrl + A
Cut	Ctrl + X
Copy	Ctrl + C
Paste	Ctrl + V

Shortcuts for Running Programs

Action	Shortcut
Run program	F5 (for Windows®), Ctrl + Alt + R (for macOS and Linux®)
Run program step	Ctrl + Enter
Run program step and advance to next step	Ctrl + Shift + Enter
Advance to next program step	Ctrl + Shift + Down arrow

Shortcuts for Help and Working with Project

Action	Shortcut
Open SimBiology documentation	F1
Create new plot	Ctrl + L
Create new datasheet	Ctrl + D
Open SimBiology project, SBML, or data file	Ctrl + O
Save project	Ctrl + S
Save project as	Ctrl + Shift + S
Close project	Ctrl + E

See Also

SimBiology Model Analyzer | SimBiology Model Builder

Related Examples













- “Create Model of Receptor-Ligand Kinetics” on page 1-11
- “Calculate NCA Parameters and Fit Model to PK/PD Data Using SimBiology Model Analyzer App” on page 1-77
- “Find Important Parameters with Local Sensitivity Analysis Using SimBiology Model Analyzer App” on page 1-41
- “Model Biological Variability with Virtual Patients Using SimBiology Model Analyzer App” on page 1-61
- “Scan Dosing Regimens Using SimBiology Model Analyzer App” on page 1-108

Message Indicator Icons in SimBiology Model Builder

The **SimBiology Model Builder** app uses contextual icons to provide more information about model components in the browser tables and blocks in the **Diagram** tab. For instance, in a model diagram,

an icon is displayed above a reaction block if it has an error: .

For more information, pause on an icon. The following table has the complete list of contextual icons and corresponding areas where they are displayed.

Icon	Description	Diagram	Browser Table
	Block has an error.	✓	✗
	Block has a warning or is not being used in a model.	✓	✗
	Block is pinned to its current location in the model diagram.	✓	✗
	Value of species, parameter, or compartment is set to be constant. In other words, the Constant property of the species, parameter, or compartment block is set to <code>true</code> .	✓	✓
	Species block has the BoundaryCondition property set to true.	✓	✓
	Species block is cloned.	✓	✗
	Reaction block has the Reversible property set to true.	✓	✗
	Reaction or rule or event has the Active property set to <code>false</code> , which means that it does not participate in the model simulation.	✓ (for reaction and rule block)	✓ (for reaction, rule, or event)
	Reaction-scoped parameter shadows (i.e., takes precedence over) a model-scoped parameter. The up arrow icon indicates the parameter that shadows. The down arrow icon indicates the parameter that is being shadowed.	✗	✓
	Value property of species, parameter, or compartment is defined by an assignment rule.	✓	✓
	Species value is being increased by one or more doses. You must select the desired doses in a program to see the dosing effects.	✓	✓
	Species, parameter, or compartment value is being modified by an event or dose.	✓	✓

See Also

[SimBiology Model Builder](#) | [SimBiology Model Analyzer](#)

More About

- “SimBiology Apps”

Copy SimBiology Blocks

When building models in the **Diagram** tab of the **SimBiology Model Builder** app, you can copy and paste blocks using **Ctrl + C** and **Ctrl + V**. You can also use the context (right-click) menu. The **Copy Options** from the context menu lets you decide whether to copy the connected states (or quantities) when copying a reaction, rule, event, or observable. The default copy options are set to `false`, which means that the app does not create copies of the connected states. You can also access the copy options from **Preferences > Model Building > Copy Options**.

- Using **Ctrl + V** increases the compartment size if there is not enough space for what you are pasting.
- Using the context menu gives you a better control of where you want the copied blocks to appear. The app uses the current location of the mouse pointer to place the new blocks.

Note On macOS, use the **command** key instead of **Ctrl**.

Compartment Blocks

If you select a compartment and copy it, the app copies the compartment block and any blocks that are inside the compartment, even if they are not visible or selected explicitly. The app does not copy any blocks that lie outside the compartment, even if they are connected to the blocks within it.

Species Blocks

If you copy a species block that is dosed, the associated dose is not copied. You can add a dose to the copied species manually in the **Doses** tab.

Reaction Blocks

If you select a reaction block, the app copies the reaction block, the reaction string, and the reaction rate. The app does not create copies of the associated species and reaction rate parameters of the reaction.

You can change the default behavior as follows. Right-click the block. Select **Copy Options > Model Building**. In the **Copy Options** section, set **When copying a reaction copy all of its states** to `true`.

Parameter Blocks

You can copy a parameter block. However, the block shows up in the diagram only if the parameter is the left-hand-side of a repeated assignment rule, rate rule, or event function. For reaction rate parameters, see “Reaction Blocks” on page 1-7.

Rule Blocks

Only repeated assignment and rate rules show up in the diagram as blocks.

If you copy a rule block, the app uses the original rule string for the copied block. In other words, the copied rule block has the connections to the same blocks as the original rule block. The app does not create copies of the associated model components.

You can change the default behavior as follows. Right-click the block. Select **Copy Options > Model Building**. In the **Copy Options** section, set **When copying a rule copy all of its states** to true.

Note In the **Browser** tables, you can copy any model component, including the ones that do not show up as blocks in the **Diagram** tab.

See Also

SimBiology Model Builder | SimBiology Model Analyzer

More About

- “SimBiology Apps”
- “Create Model of Receptor-Ligand Kinetics” on page 1-11
- “Keyboard Shortcuts for SimBiology Model Builder” on page 1-2

SimBiology Model Component Libraries

The SimBiology libraries are collections of built-in kinetic laws, units, and unit prefixes that you can use while configuring reactions and quantity units in your model.

The built-in **Abstract Kinetic Laws** library provides a list of predefined reaction rates that follow particular kinetics, such as the mass action or Michaelis-Menten kinetics. The **Units** library provides a list of available units and corresponding unit compositions. The **Unit Prefixes** library provides a list of prefixes and corresponding exponent values for unit prefixes.

You can also add custom components to any library. For instance, you can define a custom unit and use it in your model. These custom components are saved across sessions of MATLAB®. The libraries are available for all SimBiology projects and are not part of any one project.

To see the list of libraries in the **SimBiology Model Builder** app, click **Libraries** on the **Home** tab. The following figure shows the kinetic laws library with all available built-in kinetic laws.

The screenshot shows the 'SimBiology Libraries' dialog box. On the left, there is a tree view of libraries: 'Builtin Libraries' (expanded to 'Abstract Kinetic Laws'), 'Units', 'Unit Prefixes', 'Custom Libraries' (expanded to 'Abstract Kinetic Laws'), 'Units', and 'Unit Prefixes'. The main area displays the 'Builtin Abstract Kinetic Laws' library as a table with 11 rows. Each row has a number, a name, and an expression. The names are: Unknown, MassAction, Henri-Michaelis-Menten, Henri-Michaelis-Menten-Reversible, Hill-Kinetics, Iso-Uni-Uni, Ordered-Bi-Bi, Ping-Pong-Bi-Bi, Competitive-Inhibition, NonCompetitive-Inhibition, and UnCompetitive-Inhibition. The expressions are mathematical formulas involving variables like Vm, S, Km, Ks, P, Kp, Ki, and I. An 'OK' button is located at the bottom right of the dialog.

	Name	Expression
1	Unknown	
2	MassAction	
3	Henri-Michaelis-Menten	$V_m \cdot S / (K_m + S)$
4	Henri-Michaelis-Menten-Reversible	$(V_m \cdot S / K_s - V_m \cdot P / K_p) / (1 + S / K_s + P / K_p)$
5	Hill-Kinetics	$V_m \cdot S^n / (K_p + S^n)$
6	Iso-Uni-Uni	$V_m \cdot (S - P / K_{eq}) / (K_{ms} \cdot (1 + P / K_{mp}) + S \cdot (1 + P / K_{iip}))$
7	Ordered-Bi-Bi	$V_m / ((K_{sa} \cdot K_{mb} / (A \cdot B)) + (K_{ma} / A) + (K_{mb} / B) + 1)$
8	Ping-Pong-Bi-Bi	$V_m / ((K_{ma} / A) + (K_{mb} / B) + 1)$
9	Competitive-Inhibition	$V_m \cdot S / (K_m \cdot (1 + I / K_i) + S)$
10	NonCompetitive-Inhibition	$V_m \cdot S / ((K_s + S) \cdot (1 + I / K_i))$
11	UnCompetitive-Inhibition	$V_m \cdot S / (K_m + S \cdot (1 + I / K_i))$

See Also

[SimBiology Model Builder](#) | [SimBiology Model Analyzer](#)

More About

- “SimBiology Apps”

Create Model of Receptor-Ligand Kinetics

This example shows how to create and simulate a simple model of receptor-ligand kinetics using the **SimBiology Model Builder** and **SimBiology Model Analyzer** apps.

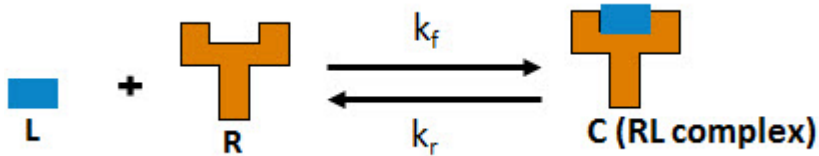

In this model, ligand L and receptor R species form receptor-ligand complexes through reversible binding reactions. These reactions are defined using mass action kinetics by $\frac{dC}{dt} = k_f \cdot L \cdot R - k_r \cdot C$, where k_f and k_r are forward and reverse rate constants. L , R , and C are the concentrations of the ligand, receptor, and receptor-ligand complex, respectively.



Open Model Builder App

Click the **SimBiology Model Builder** icon on the **Apps** tab or enter `simBiologyModelBuilder` at the command line.

Build Model

- 1 On the **Home** tab of the app, select **Model > Create New Blank Model**. Enter `m1` as the name for the model. The app creates an empty compartment unnamed and displays the compartment on the **Diagram** tab.
- 2 Drag and drop three species blocks  and one reaction block  into the compartment. Optionally, you can rename the species and compartment by double-clicking the default names. For instance, change `unnamed` to `cell`.

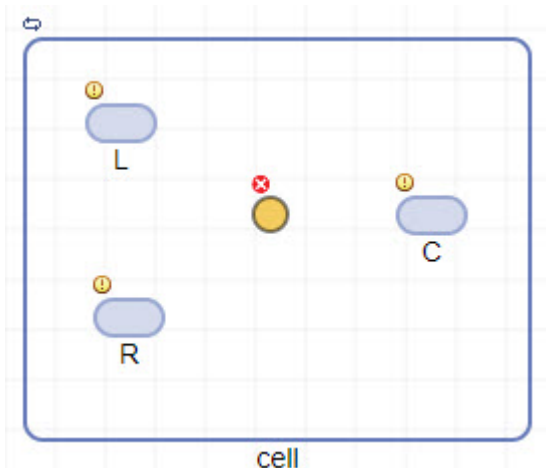

- 3 To connect the species to the reaction, press and hold the **Ctrl** key (on Windows and Linux) or the **Option** key (on macOS), click the species block, and drag the line.

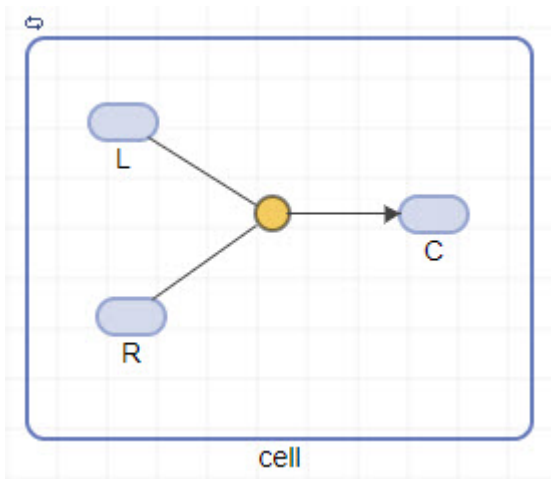

- 4 Click the reaction block to see its properties in the **Property Editor** pane. Set the following parameters.
- Select **Reversible** > **true**.
 - In the **States** table, update the values of L to 5 and R to 10. Set the units of the L , R , and C species to nanomole/liter.
 - Set the value of the forward rate parameter k_f to 0.05. Set the unit to liter/nanomole/hour.
 - Set the value of the reverse rate parameter k_r to 0.1 with the unit 1/hour.

PROPERTY EDITOR

REACTION			
NAME Reaction_1			
ACTIVE true			
REACTION $L + R \leftrightarrow C$			
REVERSIBLE true			
REACTION RATE $k_f * L * R - k_r * C$			
KINETIC LAW Kinetic Law = MassAction <input type="checkbox"/> Forward = kf <input type="checkbox"/> Reverse = kr			
STATES			
	Name	Value	Units
1	<input type="checkbox"/> L	5	nanomole/liter
2	<input type="checkbox"/> R	10	nanomole/liter
3	<input type="checkbox"/> C	0	nanomole/liter
4↔	<input type="checkbox"/> kf	0.0500	liter/nanomole/hour
5↔	<input type="checkbox"/> kr	0.1000	1/hour
6			

Simulate Model

- 1 On the **Home** tab, click the **Model Analyzer** icon to open the **SimBiology Model Analyzer** app.
- 2 In the **Model Analyzer** app, select **Program > Simulate Model** on the **Home** tab. The **Program1** tab opens.
- 3 In the **Simulation** step of the program, set the **Stop Time** to 20 seconds because the model reaches a saturated state after that. Click **Run** from the **Home** tab.

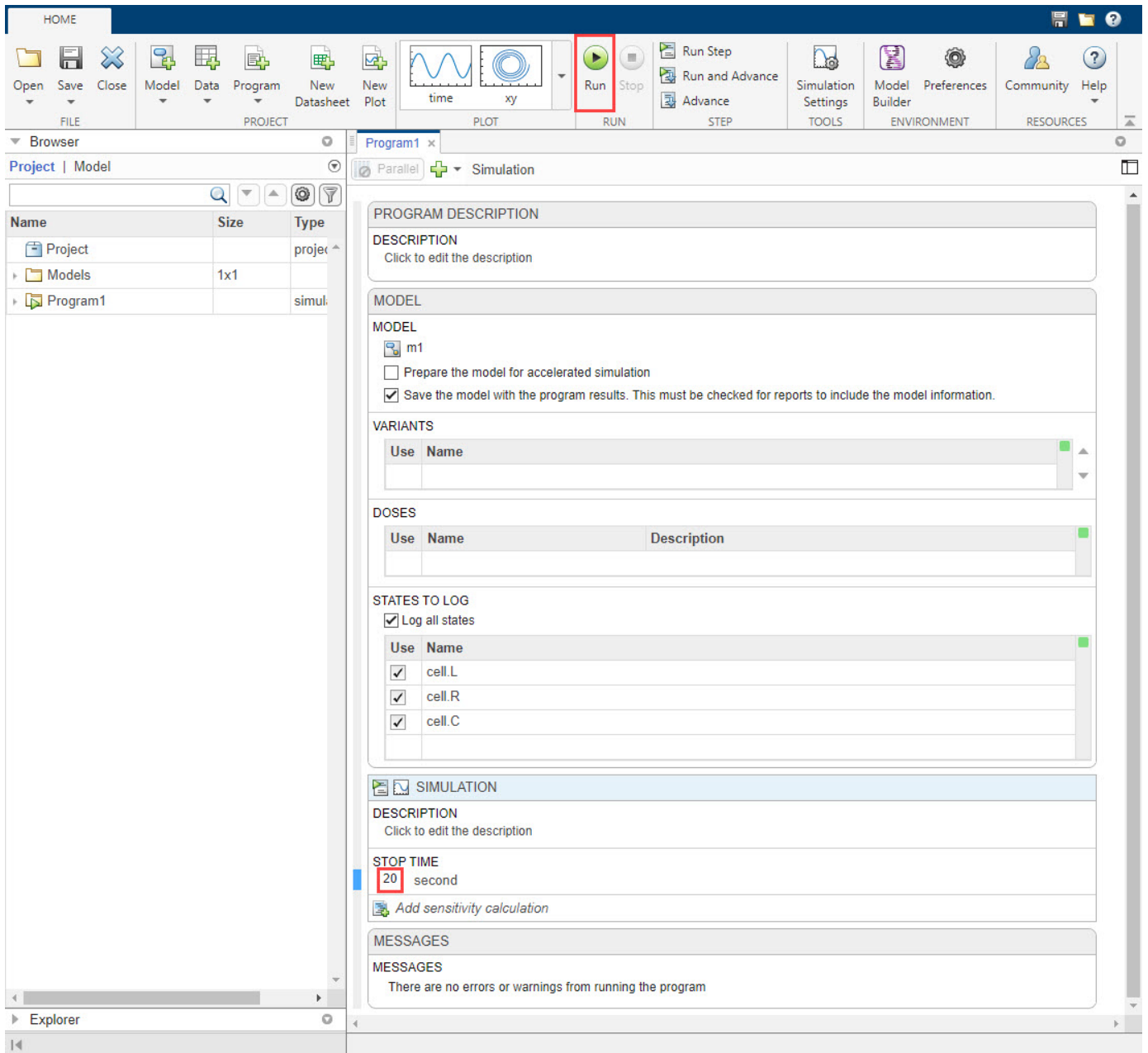

- 4 Running the program plots the results in the **Plot1** tab. The plot shows the simulated responses in different colors. The program stores the simulation **results** in the **LastRun** folder of the program.

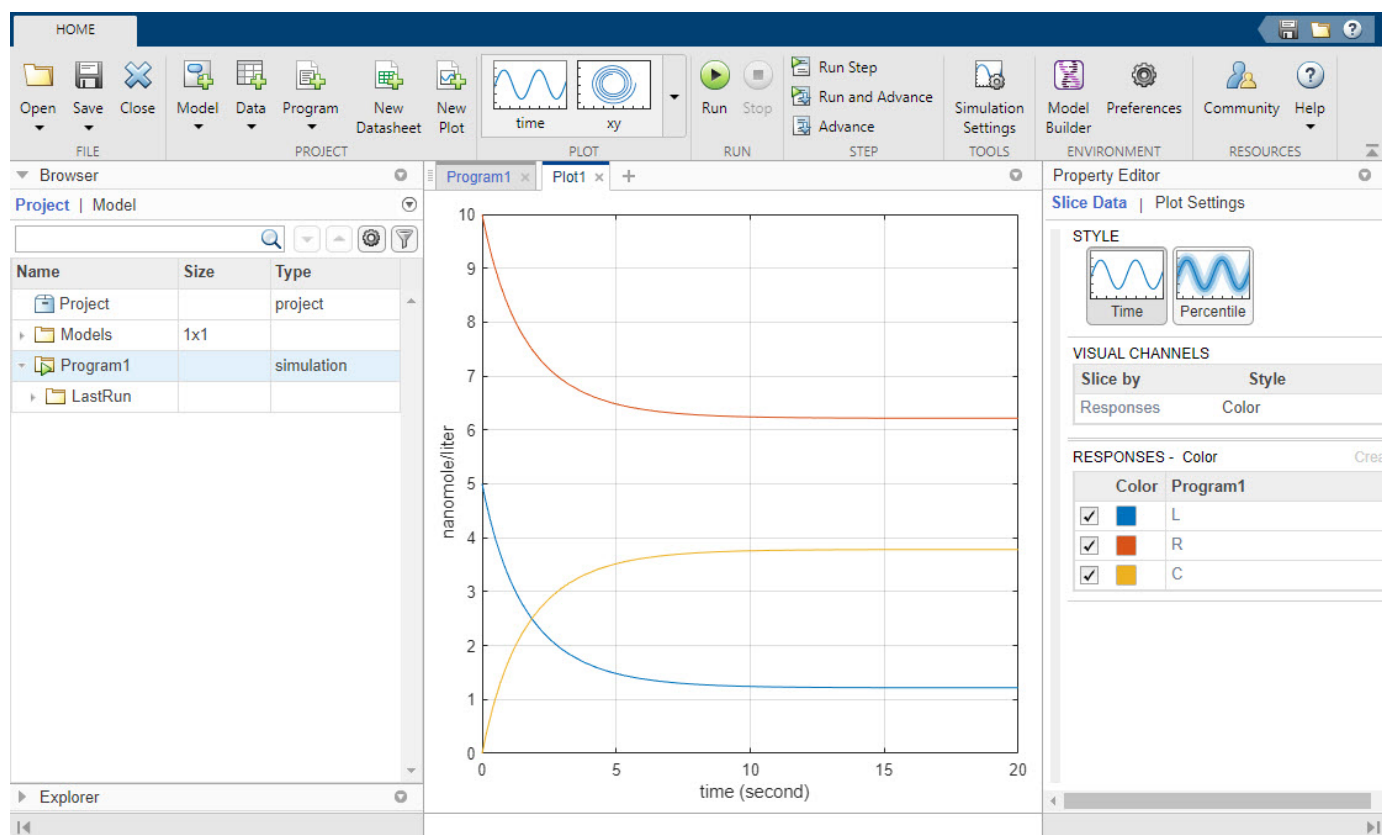

See Also

SimBiology Model Builder | SimBiology Model Analyzer

More About

- “SimBiology Apps”
- “Calculate NCA Parameters and Fit Model to PK/PD Data Using SimBiology Model Analyzer App” on page 1-77
- “Find Important Parameters with Local Sensitivity Analysis Using SimBiology Model Analyzer App” on page 1-41
- “Model Biological Variability with Virtual Patients Using SimBiology Model Analyzer App” on page 1-61
- “Scan Dosing Regimens Using SimBiology Model Analyzer App” on page 1-108

Incorporate SGLT2 Inhibition into Physiologically Based Glucose-Insulin Model Using SimBiology Model Builder

This example shows how to add SGLT2 inhibition by a hypothetical compound to an existing glucose-insulin model using **SimBiology Model Builder**.

Glucose-Insulin Model

This model is another SimBiology implementation of the glucose-insulin model referenced in the “Simulating the Glucose-Insulin Response” on page 4-166 example. The model is based on the publication by Dalla Man, et al. In their 2007 publication [1], the authors developed a model for the human glucose-insulin response after a meal. This model describes the dynamics of the system using ordinary differential equations. The authors used their model to simulate the glucose-insulin response after one or more meals, for normal human subjects and for human subjects with various kinds of insulin impairments.

Sodium-Glucose Cotransporter-2 (SGLT2) Inhibition

The SGLT2 receptor has been shown to facilitate around 50% of renal glucose reabsorption [3]. This example assumes to have a hypothetical SGLT2 inhibitor compound that inhibits SGLT2 by 50%. A reasonable dosing regimen and PK properties are also assumed. In this example, you incorporate the pharmacokinetics/pharmacodynamics (PK/PD) of this inhibitor compound into the glucose-insulin model.

Incorporate Inhibitor PK by Adding and Configuring Reactions

In the following steps, you model the compound absorption and clearance of a hypothetical SGLT2 inhibitor compound by using two reactions.

Load Model

- 1 Open the **SimBiology Model Builder** app by clicking **SimBiology Model Builder** on the **Apps** tab or by typing `simBiologyModelBuilder` at the command line.
- 2 On the **Home** tab of the app, select **Open**.
- 3 Navigate to the folder `matlabroot\examples\simbio\data\`. *matlabroot* is the folder where you have installed MATLAB. Entering `matlabroot` at the command line gives you the path to the root folder. Select the project file named `SGLT2_model_incomplete.sbproj`. Click **Open**.

Add and Configure Reactions

Note On macOS, use the **command** key instead of **Ctrl**.

- 1 Drag and drop two species blocks from the toolbar of the **Diagram** tab. You can place them below the annotation block **Therapy**, which is just a label (text) block.

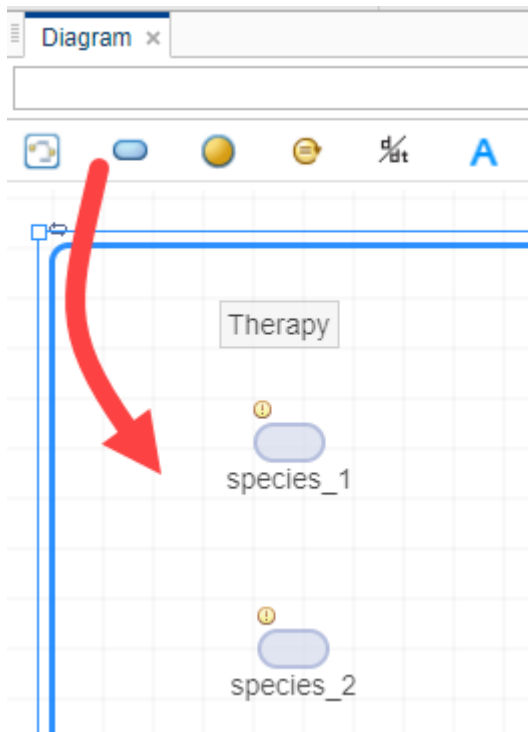

- 2 Press **Ctrl** and drag a line from the first species to the second species. A reaction block appears in between. This reaction represents the compound absorption.
- 3 Edit the default species name by double-clicking it. Rename `species_1` to `GI_SGLT2_Inhib` and `species_2` to `Plasma_SGLT2_Inhib`.

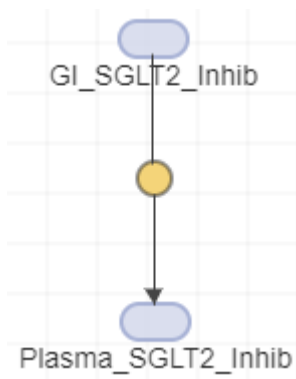

- 4 Click the reaction block. In the **Property Editor** pane on the right, change the reaction **Name** to `compound_absorption`.
- 5 In the **Kinetic Law** section, change the autogenerated **Forward** rate parameter **kf** to `k_compound_absorption`. The model already has the forward rate parameter `k_compound_absorption` that was created previously. The app uses green text for parameter names and blue text for species names in the reaction rate expression.

Tip To change the default reaction configurations, click **Preferences** on the **Home** tab. In the preferences dialog, click **Model Building**. In the **Reaction Building** section, there are three

options to change the default kinetic law, create parameters for the kinetic law, and change the scope of created parameters.

- 6 In the **States** table, set the units of the two species to milligram.

PROPERTY EDITOR

REACTION

NAME
4.

ACTIVE
true

REACTION
GI_SGLT2_Inhib -> Plasma_SGLT2_Inhib

REVERSIBLE
false

REACTION RATE
k_compound_absorption*GI_SGLT2_Inhib

KINETIC LAW
Kinetic Law = MassAction
5. Forward = k_compound_absorption

STATES

	Name	Value	Units
1	<input type="checkbox"/> GI_SGLT2_Inhib	0	6. milligram
2	<input type="checkbox"/> Plasma_SGLT2_Inhib	0	milligram
3	<input checked="" type="checkbox"/> k_compound_absorption	0.0340	1/minute
4			

- 7 Drag and drop another reaction block from the diagram toolbar to model the compound clearance.
- 8 Press **Ctrl** and drag a line from Plasma_SGLT2_Inhib to the reaction.

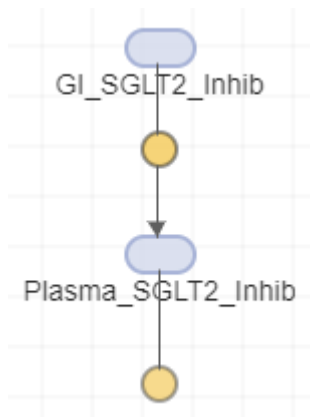

Tip If the blocks are not aligned, you can align them using the alignment tools. On the **Home** tab, select **Diagram Tools** > **Diagram Alignment Tools**.

- 9** Click the reaction block. In the **Property Editor** pane, change the reaction **Name** to `compound_clearance`.
- 10** Update the **Reaction Rate** to $CL/Vd \cdot \text{Plasma_SGLT2_Inhib}$. *CL* and *Vd* indicate the model parameters for the clearance and volume of distribution, respectively.

PROPERTY EDITOR

REACTION

NAME
9.

ACTIVE
true

REACTION
`Plasma_SGLT2_Inhib -> null`

REVERSIBLE
false

REACTION RATE
10.

KINETIC LAW
Kinetic Law = Unknown

STATES

	Name	Value	Units
1	<input type="checkbox"/> Plasma_SGLT2_Inhib	0	milligram
2↔	<input type="checkbox"/> CL	0.0160	liter/minute
3↔	<input type="checkbox"/> Vd	6.1000	liter
4			

Tip

- The kinetic law for a newly added reaction is configured to **MassAction** by default, and the **SimBiology Model Builder** app automatically creates and maps the species and parameters needed by the reaction rate. For other kinetic laws, only parameters are created and mapped. You need to create and map the species manually. Use the **Unknown** kinetic law to define a custom reaction rate with its own parameters. You must define and add the species and parameters needed by the custom rate.
- The **MassAction** and **Unknown** kinetic laws can have different simulation results even when the reaction rate is the same. This can happen when you have a reversible reaction with species in different compartments. The difference in simulation results is because of the volume-scaling performed by SimBiology during the dimensional analysis. For details, see “Deriving ODEs from Reactions” on page 4-5. Specifically, for **MassAction**, SimBiology uses corresponding compartment volumes to multiply the forward and reverse rates. However, for **Unknown** and other built-in kinetic laws, SimBiology multiplies the entire rate by only one compartment which

contains the reactants. To see exactly what compartment volumes are used for scaling, open the Equations on page 1-31 tab and check the **ODEs** section.

Incorporate Inhibitor PD Using Mathematical Equation

SimBiology lets you define a mathematical expression to define or update the value of a model quantity during simulation. For details, see “Definitions and Evaluations of Rules in SimBiology Models” on page 2-13. In the following steps, you add a repeated assignment rule to incorporate the inhibitor pharmacodynamics by defining the renal threshold at which plasma glucose is excreted based on the compound efficacy.

- 1 In the **Browser** pane, click the plus icon on the browser toolbar and select **Add Repeated Assignment**. The app moves the focus to the last empty row in the **Repeated Assignments** table.

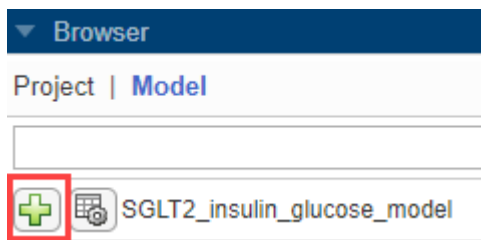

- 2 Double-click the row and enter the following expression that represents the compound inhibition based on the Hill equation:

```
renal_threshold = basal_renal_threshold*(1-
compound_Imax*Whole_Body.Plasma_SGLT2_Inhib^2/
(compound_IC50^2+Whole_Body.Plasma_SGLT2_Inhib^2))
```

```
renal_threshold = basal_renal_threshold*(1-
compound_Imax*Plasma_SGLT2_Inhib^2/(compound_IC50^2+Plasma_SGLT2_Inhib^2))
```

The **Diagram** tab now shows the repeated assignment rule block for the renal_threshold parameter.

Tip To view the entire model and pan through it, expand **Model Assessment Tools** in the **Browser** pane and click **Overview**.

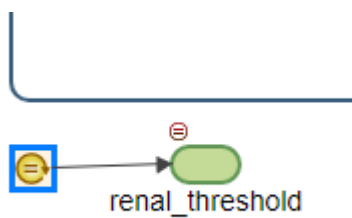

Note

- The app shows only a parameter block for a parameter that is on the left hand side (LHS) of a repeated assignment rule, rate rule, or event function.
- The app shows only rule blocks for repeated assignments and rate rules.
- The app uses dash-dot lines to connect the quantities on the right hand side of a rule. By default, these lines are not shown. To display the lines, click a rule block. From the **Property Editor** pane, in the **Block** section, set **Expression Lines** to **show**.

Update Renal Excretion Reaction to Incorporate Presence of Inhibitor Compound

The renal excretion reaction of the model is currently defined as $\text{Plasma_Glucose} \rightarrow \text{Urinary_Glucose_Excr_AUC}$ with the reaction rate parameter `glucose_excretion`. The rate parameter is defined by a repeated assignment rule as $\text{glucose_excretion} = (\text{Plasma_Glucose} > \text{renal_threshold}) * \text{GFR} * (\text{Plasma_Glucose} - \text{renal_threshold})$, where GFR is a glomerular filtration rate that determines the flux of the reaction and has impact on SGLT2 inhibition effect.

In the following steps, you update the renal excretion reaction to $\text{Plasma_Glucose} + \text{Plasma_SGLT2_Inhib} \rightarrow \text{Plasma_SGLT2_Inhib} + \text{Urinary_Glucose_Excr_AUC_24hr}$, where the inhibitor compound `Plasma_SGLT2_Inhib` is both a reactant and product of the reaction.

- 1 In the **Diagram** tab, click the gray square reaction block named `Renal excretion`.

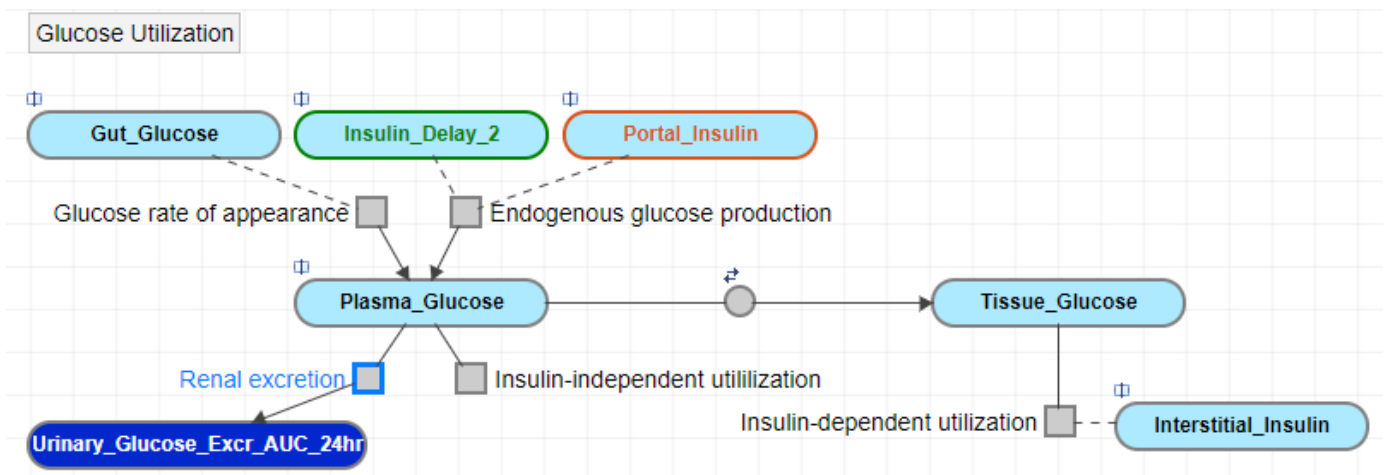

- 2 In the **Property Editor** pane, update the **Reaction** string to $\text{Plasma_Glucose} + \text{Plasma_SGLT2_Inhib} \rightarrow \text{Plasma_SGLT2_Inhib} + \text{Urinary_Glucose_Excr_AUC_24hr}$. A dashed line now connects `Plasma_SGLT2_Inhib` to the reaction block on the **Diagram** tab.

Note SimBiology uses a dashed line to indicate that a species is both a reactant and product of a reaction and is not being consumed by the reaction.

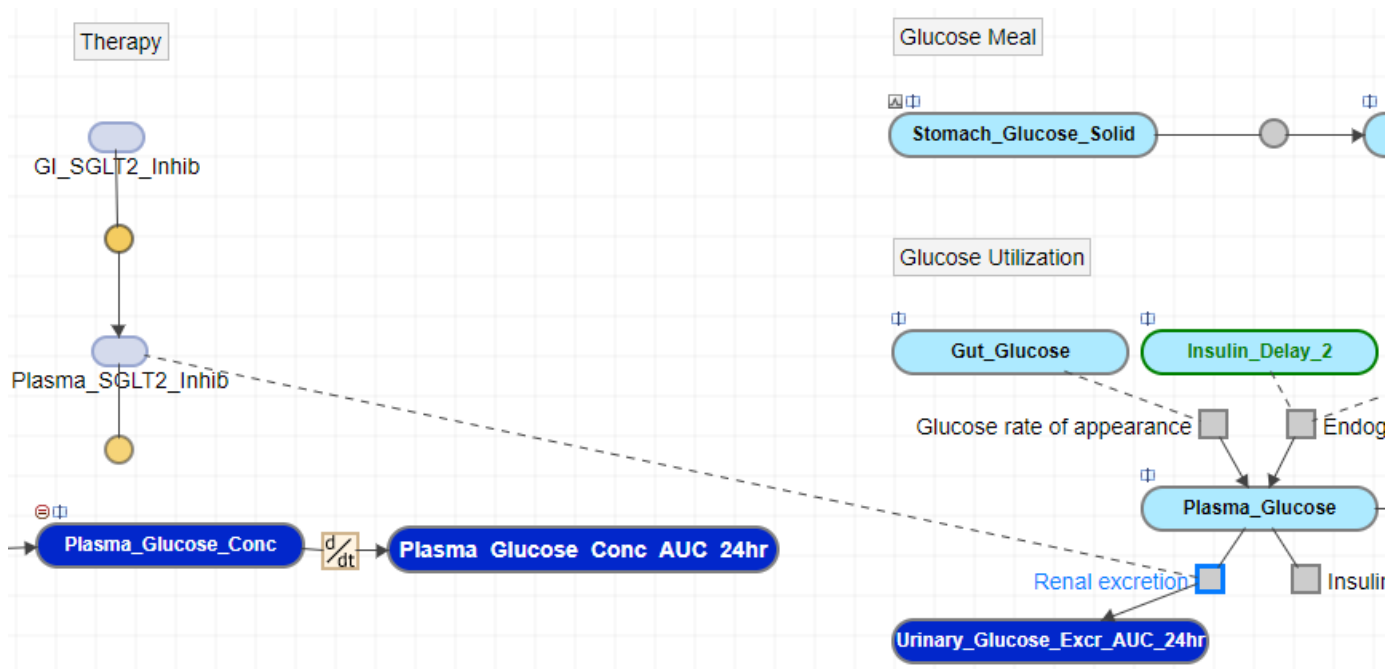

Split and Clone Block

When there are multiple references to the same quantity, multiple lines are connected to the block. To make the diagram clearer, you can split the block, that is, create copies of the same block, so that each reference is connected to a different copy of the block. You can also clone a block to add another use for it. For instance, you can first clone a species block to reference in multiple expressions. You can then use each clone in each expression as you build the model.

In the following steps, you clone the `Plasma_SGLT2_Inhib` block. These steps are optional and do not have any effect on the model behavior.

- 1 Click the `Plasma_SGLT2_Inhib` block in the diagram.
- 2 In the **Property Editor** pane, scroll to the **Split** section.
- 3 Click **Clone**.

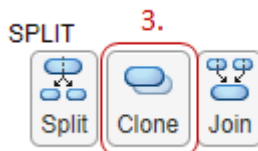

- 4 In the **Diagram** tab, a cloned block appears next to the original block. Each block now has a clone indicator.

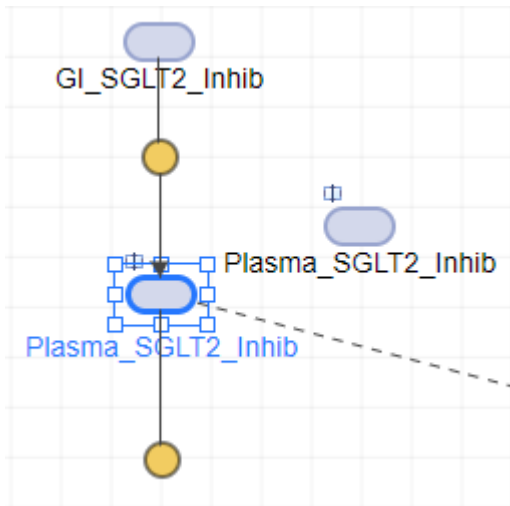

- 5 You can now move the dashed line to the cloned block. First click the dashed line. Press **Ctrl** and drag the dashed line to the cloned block. A green plus icon appears when the line is near the cloned block. Release the mouse to attach the line to the cloned block.

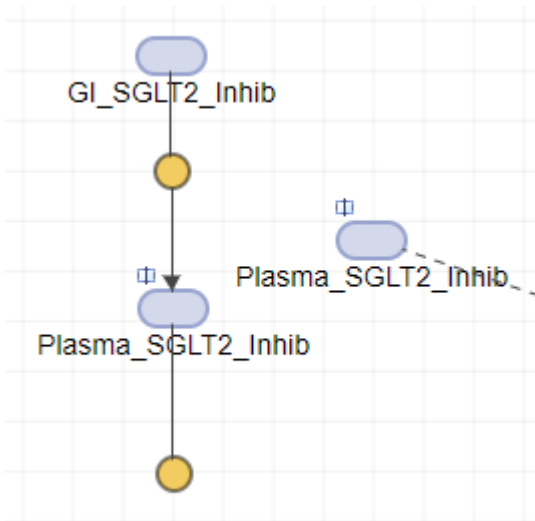

- 6 You can now move the cloned block closer to the Renal excretion reaction block to make the diagram easier to read.

Incorporate Sudden Changes in Model Behavior Using Event

You can model sudden changes in model behavior based on a specified condition. For example, you can reset a species amount at a certain time point or when a certain concentration threshold is crossed. SimBiology lets you model such changes using a modeling component called an event. An event lets you specify discrete transitions in quantity values that occur when a custom condition becomes true. Such a condition is called an event trigger. Once the condition becomes true, one or more event functions are executed. For details, see “Events in SimBiology Models” on page 2-22.

In the following steps, you reset the total amount of urinary glucose to zero every 24 hours by adding one event trigger and five event functions.

- 1 Click the plus icon on the Browser toolbar. Select Add Event. The app moves the focus to the last empty row in the **Events** table.

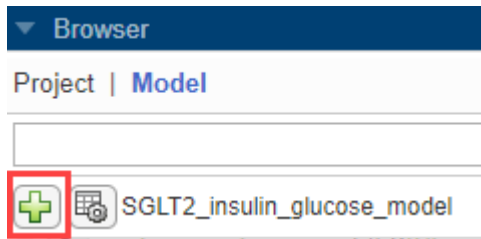

- 2 Enter the following event trigger: $\text{time} \geq (\text{num_day}+1)*\text{timeDay}$.
- 3 In the next **EventFcn** row, enter $\text{Urinary_Glucose_Excr_AUC_24hr} = 0$.

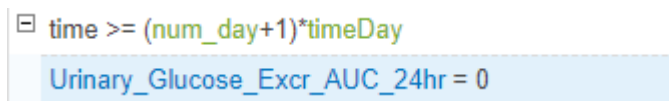

- 4 To add a second event function to the same event, go to the **Property Editor** pane of the event. In the **Event Fcns** table, double-click the empty row and enter the following: $\text{num_day} = \text{num_day} + 1$.

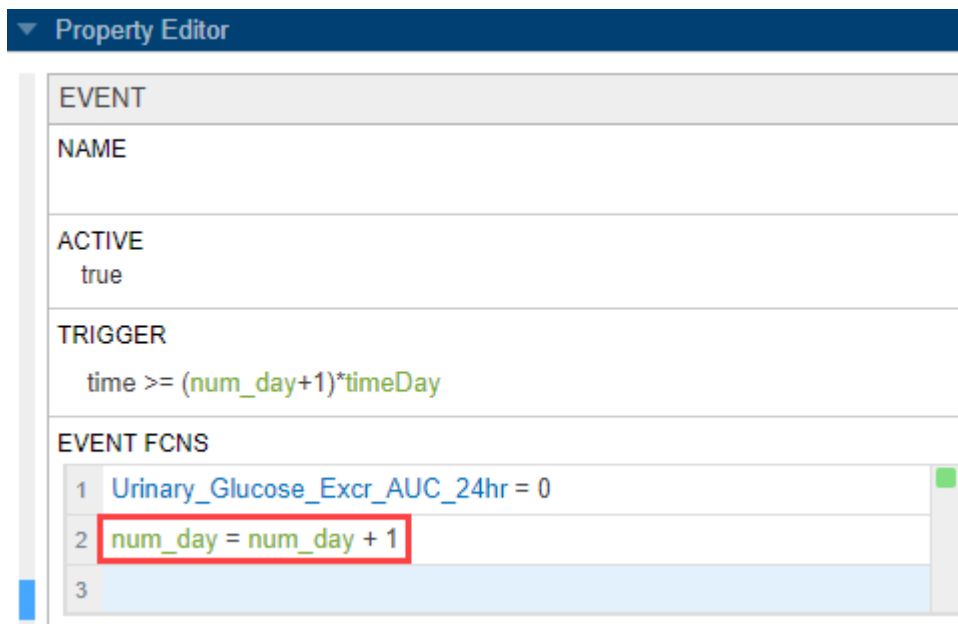

- 5 Add three more event functions as follows:
 - $\text{Plasma_Glucose_Conc_AUC_24hr} = 0$
 - $\text{Vmax_dep_glucose_util} = \text{Vmax_dep_glucose_util_baseline}$
 - $\text{beta_glucose_signal} = \text{beta_glucose_signal_baseline}$

EVENT FCNS	
1	Urinary_Glucose_Excr_AUC_24hr = 0
2	num_day = num_day + 1
3	Plasma_Glucose_Conc_AUC_24hr = 0
4	Vmax_dep_glucose_util = Vmax_dep_glucose_util_baseline
5	beta_glucose_signal = beta_glucose_signal_baseline
6	

Add Doses

SimBiology lets you model the increase in the amount of a species due to a stimulus such as an oral or intravenous administration of a drug. To model such an increase in a species amount, use the dose on page 2-30 modeling component. In the following steps, you model the intake of the inhibitor drug, such as one time per day for x numbers of days, by dosing the GI_SGLT2_inhib species.







- 1 In the **Browser** pane, click the **Show doses** icon on the toolbar.

Name	Value	Units
Insulin_Delay_2	0	picomole/liter
Insulin_Delay_1	0	picomole/liter
Plasma_Insulin Conc	0	picomole/liter

The **Doses** tab appears. In the **Doses** section, each row represents a dose. The **Type** column lets you choose between **Repeat Dose** (default) and **Schedule Dose**. The **Active** column lets you select which doses to apply when you simulate the model.

- 2 Double-click the **Name** column in the last empty row and enter SGLT2 Inhib QD.

DOSES (SGLT2_insulin_glucose_model)

	Type	Active	Name
1		<input type="checkbox"/>	Single Meal
2		<input type="checkbox"/>	Single Day
3		<input type="checkbox"/>	Daily Breakfast
4		<input type="checkbox"/>	Daily Lunch
5		<input type="checkbox"/>	Daily Evening
6		<input type="checkbox"/>	SGLT2 Inhib QD
7			

- 3 In the **Properties** section, for **Target Name**, enter GI_SGLT2_Inhib and select Whole_Body.GI_SGLT2_Inhib.
- 4 In the **Dose** section, enter the following:
 - **Amount** = 300
 - **Rate** = 0
 - **StartTime** = timeBreakfast
 - **Interval** = 1440
 - **RepeatCount** = 7
- 5 In the **Units** section, enter the following:
 - **AmountUnits** = milligram
 - **RateUnits** =
 - **TimeUnits** = minute

PROPERTIES	
TARGET NAME	Whole_Body.GI_SGLT2_Inhib
DURATION PARAMETER NAME	
LAG PARAMETER NAME	
DOSE	Amount = 300 Rate = 0 StartTime = timeBreakfast Interval = 1440 RepeatCount = 7
UNITS	AmountUnits = milligram RateUnits = TimeUnits = minute
EVENT MODE	stop

Represent Biological Variability Using Variants

You can model biological variability using a modeling component called a variant on page 2-29. A variant is a collection of quantities with alternative values. For instance, in this example, you can have a set of parameter values for a type 2 diabetic patient and another set of values for a patient without type 2 diabetes.

For the purposes of this example, the model already has two variants. In the following steps, you open the **Variants** tab, where you can edit or add more variants.

- In the **Browser** pane, click the **Show variants** icon on the toolbar.

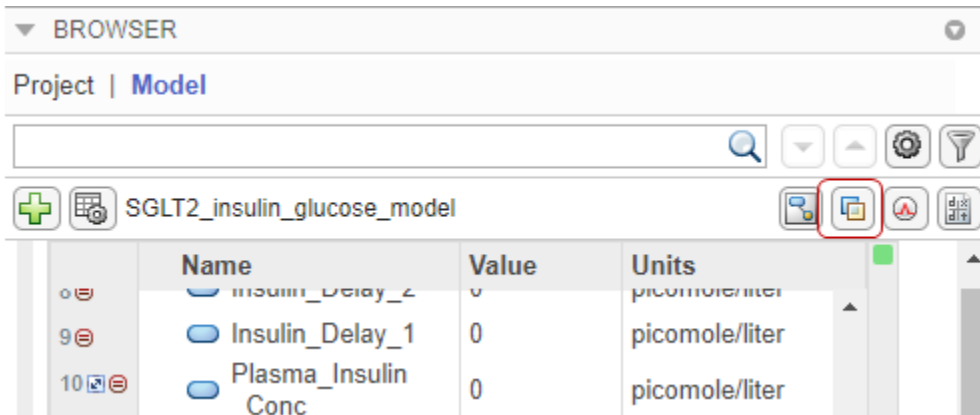

The **Variants** tab appears. In the **Variants** section, each row represents a variant. The **Active** column lets you select which variants to apply when you simulate the model. You can select multiple variants, and if there are duplicate specifications for a quantity value, the last occurrence for the value in the array of variants is used during simulation. The app applies the variants in the order that they appear in the table from top to bottom. Reordering the variants can change the initial conditions because the variants are applied in the new order. Make sure that you provide the correct order when you simulate the model in the **Model Analyzer** app. The **Value** column in the **Content** section shows the final quantity value after applying all variants that you have selected.

VARIANTS (SGLT2_insulin_glucose_model)

Active	Name
<input type="checkbox"/>	Type 2 diabetic
<input type="checkbox"/>	Healthy
<input type="checkbox"/>	

CONTENT

DISPLAY
Show only those quantities being used by the variant

VALUE

Type	Name	Value	Model Value
parameter	plasma_vol_glucose	1.4900	1.88 deciliter/kilogram
parameter	k_tissue_plasma	0.0420	0.065 1/minute
parameter	k_plasma_tissue	0.0710	0.079 1/minute
parameter	plasma_vol_insulin	0.0400	0.05 liter
parameter	k_insulin_plasma_liver	0.3790	0.19 1/minute
parameter	k_insulin_liver_plasma	0.6730	0.484 1/minute
parameter	k_insulin_deg_plasma	0.2690	0.1936 1/minute
parameter	hepatic_extract_dep	0.0526	0.0304 minute/picomole
parameter	hepatic_extract_basal	0.8118	0.6469 dimensionless
parameter	gastric_emptying_kmax	0.0465	0.0558 1/minute
parameter	gastric_emptying_kmin	0.0076	0.008 1/minute

- By default, the **Content** section shows only those quantities being modified by the variant. To see all model quantities, select Show all quantities in the model in the **Display** section.

CONTENT

DISPLAY
Show only those quantities being used by the variant

▼
Show only those quantities being used by the variant
Show all quantities in the model

Show Model Equations and Initial Conditions

You can view the underlying system of equations, namely, ordinary differential equations (ODEs) and rules that represent the model. SimBiology derives the ODEs from model reactions, and the ODEs define what quantities to integrate during model simulation. For details, see “Model Simulation” on page 4-3.

You can use the model equations and initial conditions to debug a model. For instance, you can check the initial conditions of ODEs to see if the quantity values are initialized as you expect. You can also see how SimBiology corrects the dimensions of ODEs by dividing the right-hand-sides of equations with compartment volumes. The volume-correction information can help you debug unexpected simulation results, especially when you have a multicompartment model with different compartment volumes.

To view the model equations, click the **Show model equations** icon on the toolbar of the **Browser** pane.

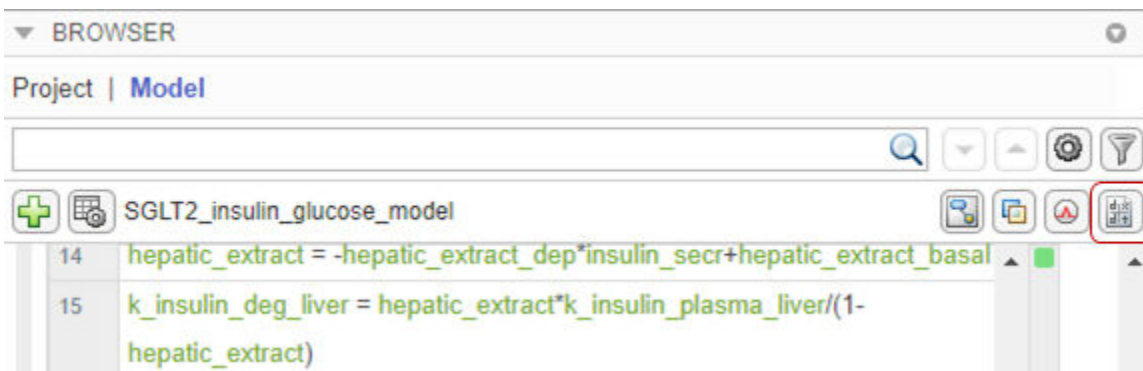

The app opens the **Equations** tab.

Reaction Fluxes

By default, the app embeds the reaction fluxes when it displays in the model equations. Clear the **Embed Fluxes** check box to see the **Fluxes** section separately.

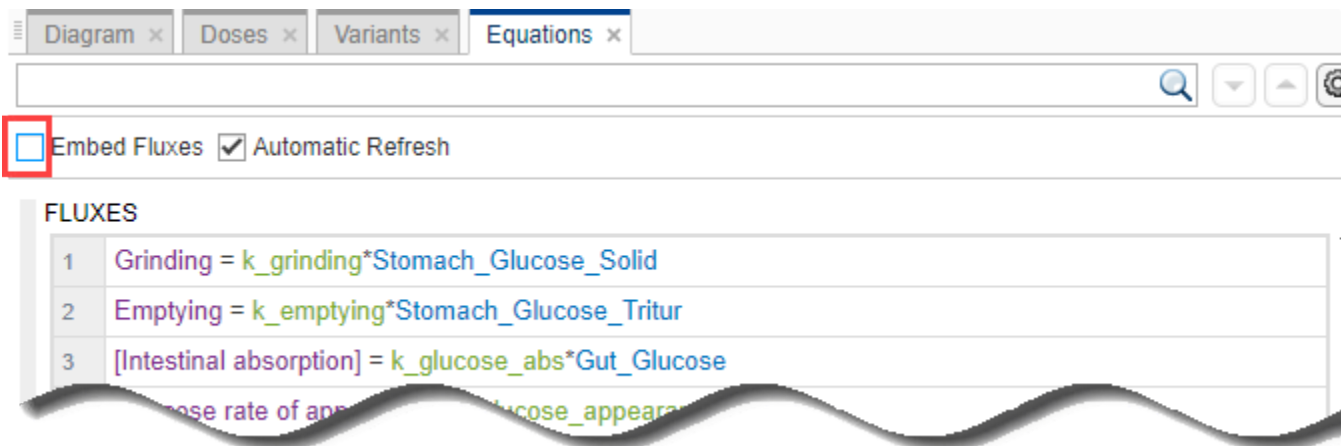

Generally, reaction fluxes are equivalent to reaction rates except that the dimensions of fluxes are always amount/time. The dimensions of reaction rates can be in concentration/time or amount/time. For details, see “Deriving ODEs from Reactions” on page 4-5.

Initial Conditions

You can view the initial conditions of model quantities, namely compartments, species, and parameters. The initial conditions are the quantity values at simulation time = 0. On the toolbar of the **Browser** pane, select **View model documents options > Show Model Initial Conditions**.

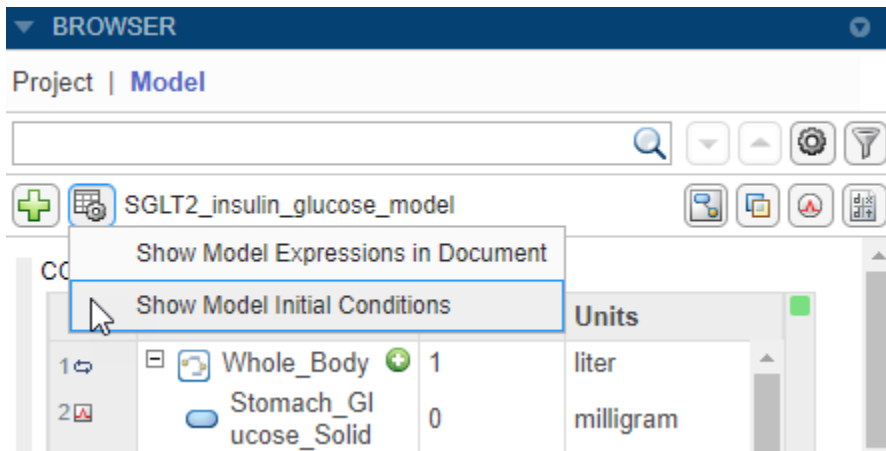

The app adds a column named **Initial Condition** to the **Compartments and Species** table and **Parameters** table.

COMPARTMENTS AND SPECIES

	Name	Value	Initial Condition	Units
1	Whole_Body	1	1	liter
2	Meal	0	0	gram
3	Stomach_Glucose_Solid	0	0	milligram
4	Stomach_Glucose_Tritur	0	0	milligram
5	Stomach_Glucose	0	0	milligram
6	Gut_Glucose	0	0	milligram
7	Plasma_Glucose	0	0	milligram
8	Plasma_Glucose_Conc	0	0	milligram/deciliter
9	Tissue_Glucose	0	0	milligram
10	Insulin_Delay_2	0	0	picomole/liter
11	Insulin_Delay_1	0	0	picomole/liter
12	Plasma_Insulin_Conc	0	0	picomole/liter
13	Interstitial_Insulin	0	0	picomole/liter

PARAMETERS

	Name	Value	Initial Condition	Units	Scope
1	timeEveningMeal	1080	1080	minute	model
2	timeLunch	720	720	minute	model
3	Stomach Glucose After Dosing	78000	78000	milligram	model
4	gastric_emptying_a	0	1.7806e-4	1/milligram	model
5	gastric_emptying_b	0.8200	0.8200	dimensionless	model
6	gastric_emptying_c	0	0.0032	1/milligram	model
7	gastric_emptying_d	0.0100	0.0100	dimensionless	model
8	k_emptying	0	0.0555	1/minute	model
9	gastric_emptying_kmin	0.0080	0.0080	1/minute	model
10	gastric_emptying_kmax	0.0558	0.0558	1/minute	model
11	k_grinding	0.0558	0.0558	1/minute	model

Define Observable Expressions

SimBiology lets you perform postsimulation calculations by defining and evaluating custom expressions. Such an expression is called an **Observable**. In the following steps, you add observable expressions to the model to calculate the C_{max} and mean values of the concentration-time profile of the plasma glucose.

- 1 Click the plus icon on the browser toolbar. Select **Add Observable**. The app moves the focus to the last empty row in the **Observables** table.

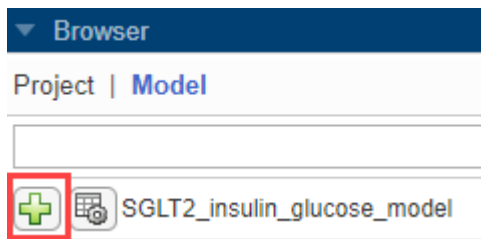

- Double-click the empty row and enter the following expression to get the Cmax value:

$$\text{Cmax_plasma_glucose} = \max(\text{Plasma_Glucose_Conc}).$$

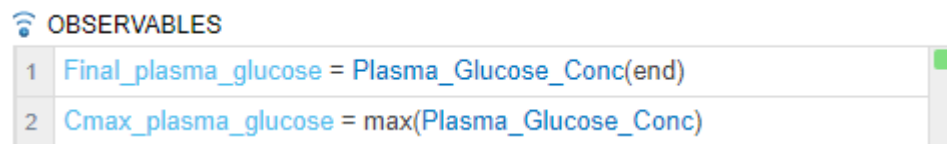

- Enter the **Units** of the observable as milligram/deciliter in **Property Editor**.

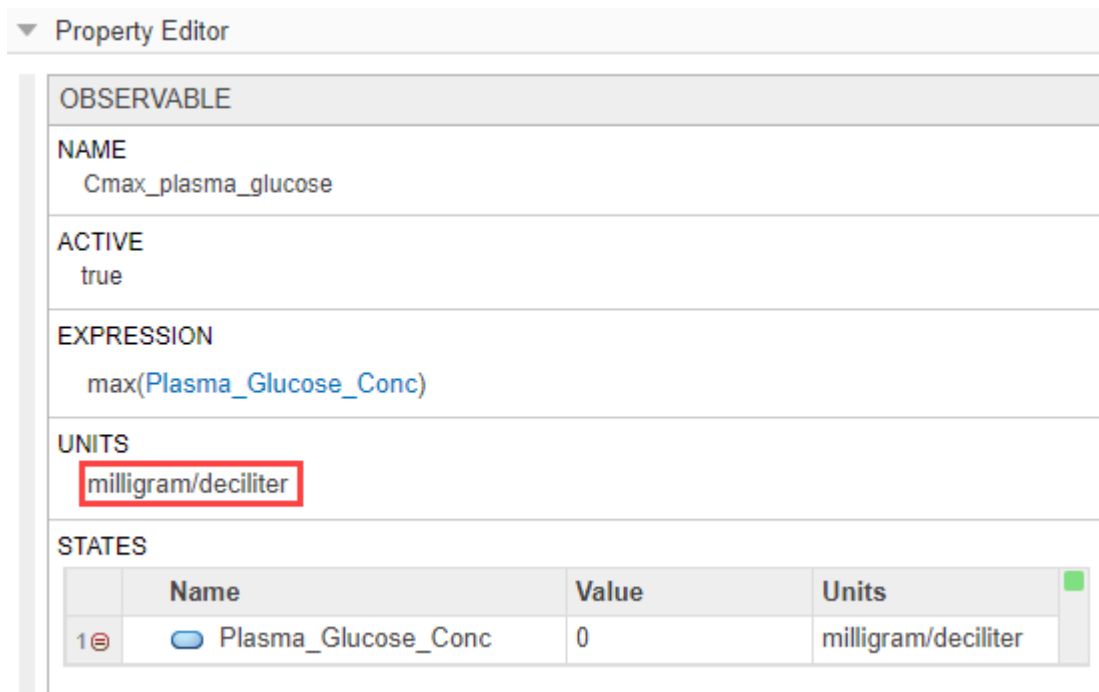

- Double-click the next empty row and enter the following expression to get the mean value:

$$\text{Mean_plasma_glucose} = \text{mean}(\text{Plasma_Glucose_Conc}).$$

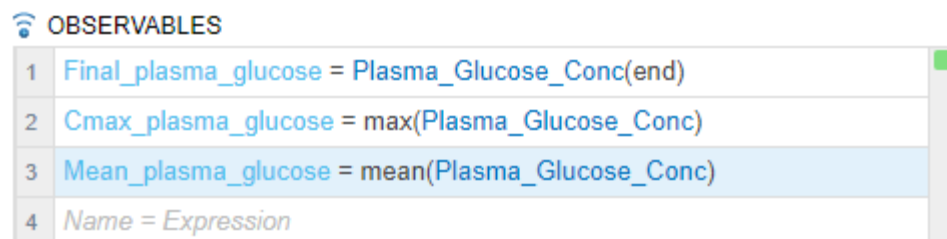

- 5 Enter the **Units** of the observable as milligram/deciliter in **Property Editor**.

Visualize Model Behavior Using Model Simulation Tool

You can visualize the model dynamics by using the **Model Simulation** tool. The tool provides a convenient way to simulate the model and plot the time courses of model quantities or observables, without having to run a simulation program in the **Model Analyzer** app.

The **Model Simulation** tool is located on the right-hand side of the app beneath the **Property Editor** pane. In the following steps, you plot the time courses of the species `Plasma_Glucose_Conc` and `GI_SGLT2_Inhib`.

Note If you have not completed the prior model building steps, you can load the completed project instead to continue this tutorial.

- 1 Open the **SimBiology Model Builder** app.
- 2 Click **Open** and navigate to the folder `matlabroot\examples\simbio\data\`. `matlabroot` is the folder where you have installed MATLAB. Select the project file named `SGLT2_model.sbproj`.

- 1 Click the arrow next to the tool name which is located below the **Property Editor** pane.

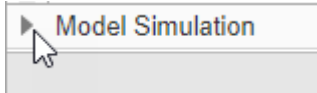

- 2 Click **Add Plot** on the toolbar.
- 3 **Plot1** appears. Double-click the cell under **Component Name** and type: `Plasma_Glucose_Conc`
- 4 As you type, the app provides suggestions. Select `Whole_Body.Plasma_Glucose_Conc`.

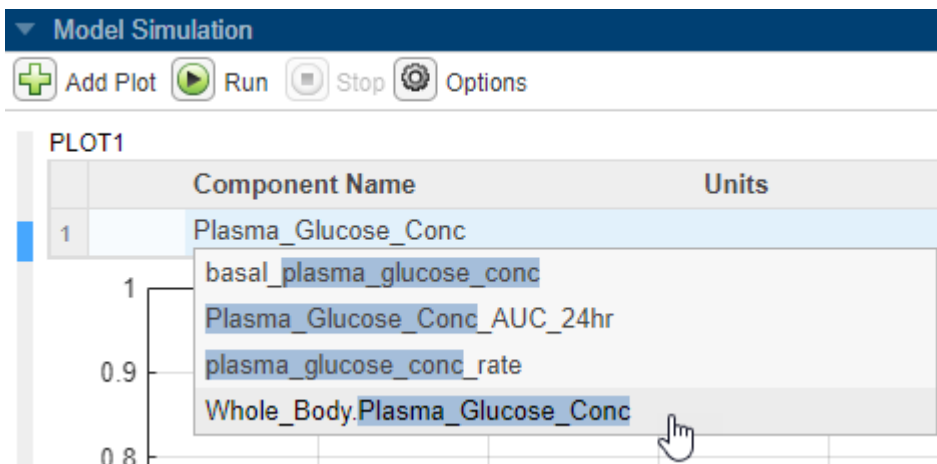

- 5 Select **Options** > Define Active Variants for Simulation. It opens the **Variants** tab.

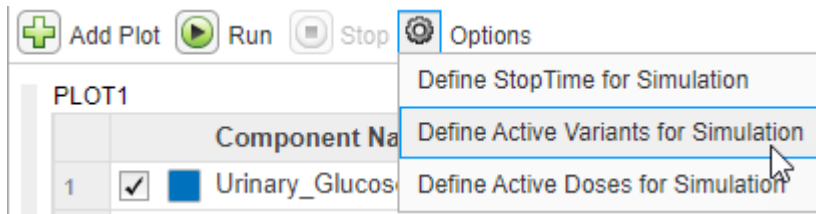

- 6 Select **Type 2 diabetic** in the Variants table.

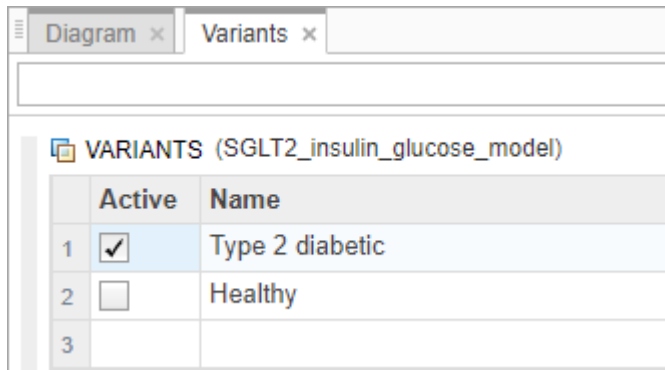

- 7 Select **Options** > Define Active Doses for Simulation. It opens the **Doses** tab. Select **Daily Breakfast**, **Daily Lunch**, **Daily Evening**, and **SGLT2 Inhib QD** in the Doses table.

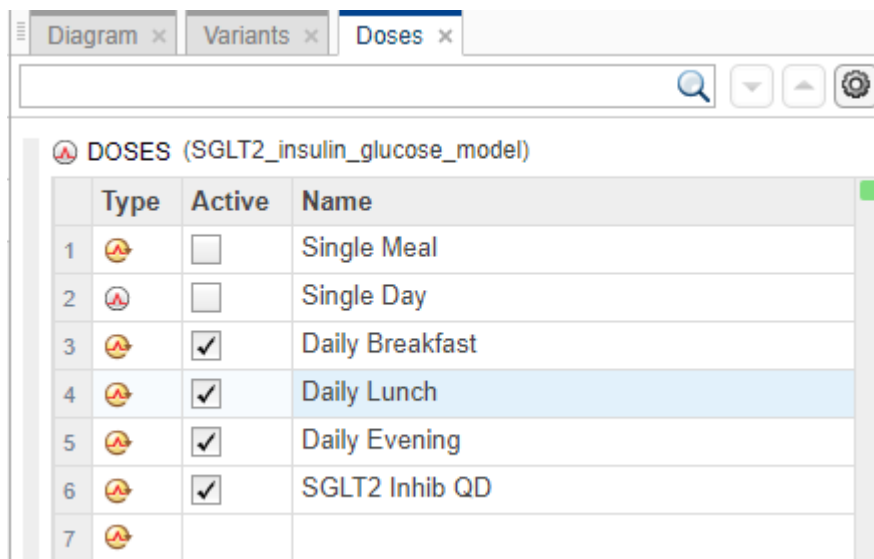

- 8 Click **Run** on the tool bar to see the time course of the species.

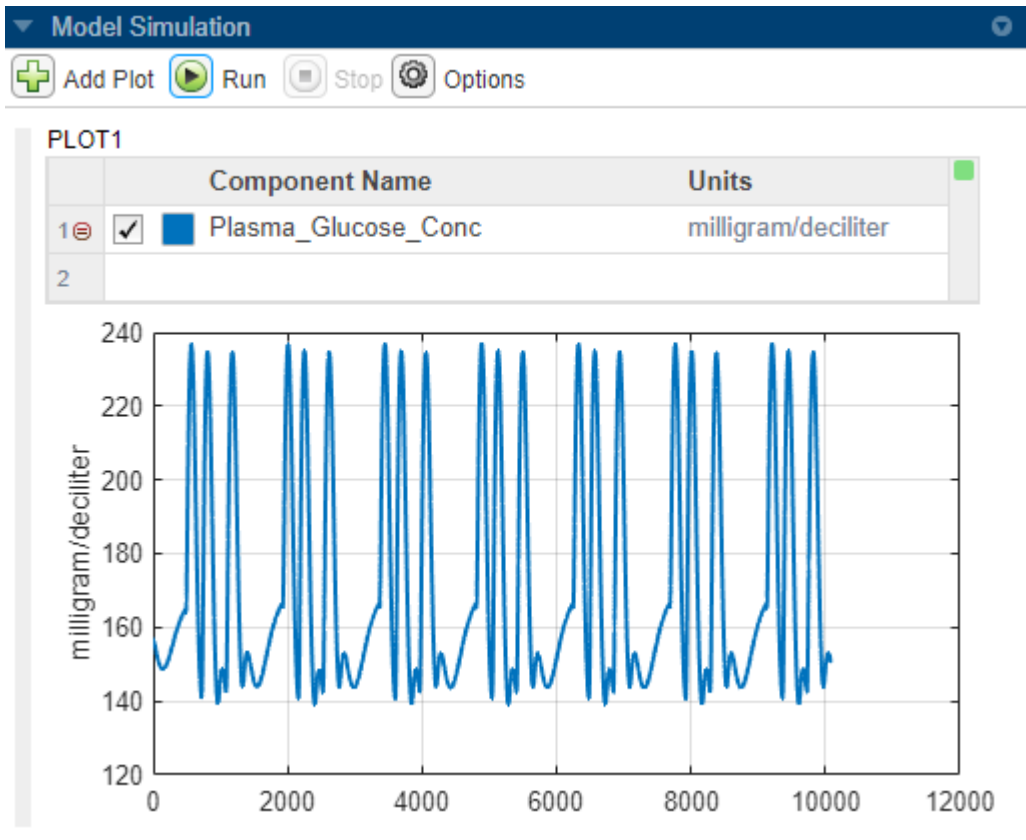

- 9 To export the plot, point the mouse to the top right corner of the table and click the options menu icon. Click **Export Plot** from the list.

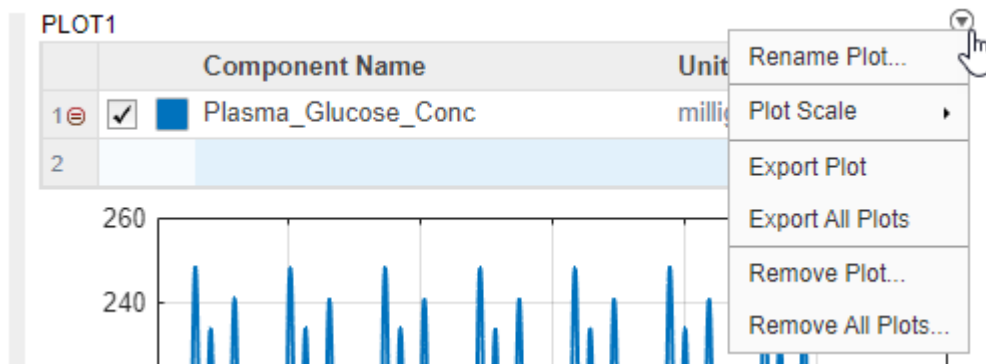

- 10 You can also use the context menu of a model quantity to add them to an existing plot or a new plot in the simulation tool. Go to the **Diagram** tab (or in the **Browser** pane), right-click the **GI_SGLT2_Inhib** species and select **Plot State > Plot1**. The species is now added to the plot.

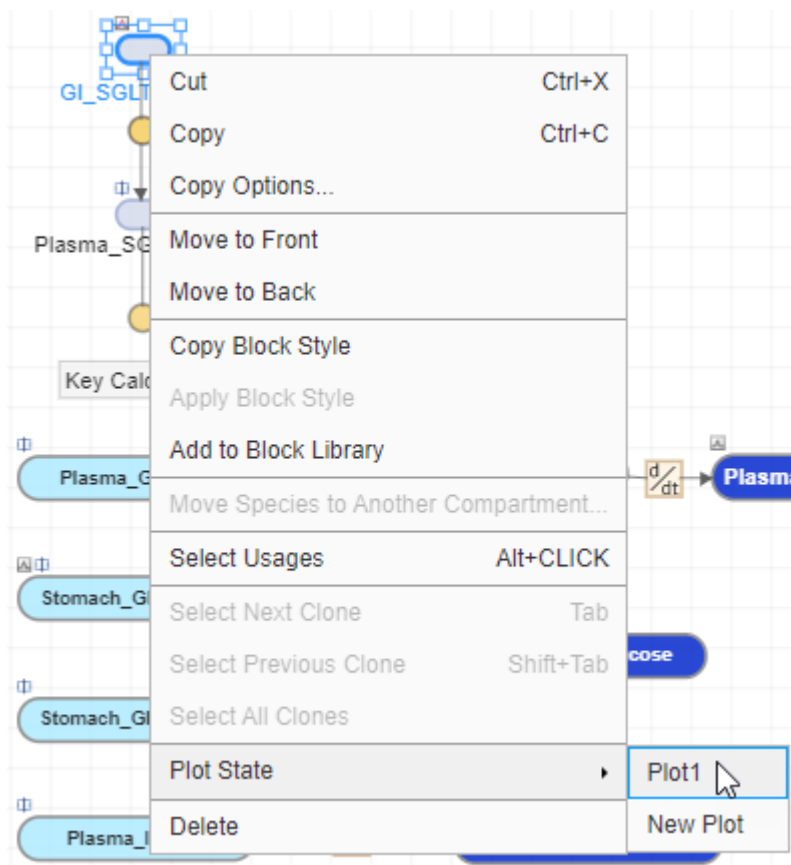

11 Click **Run** again to update the plot.

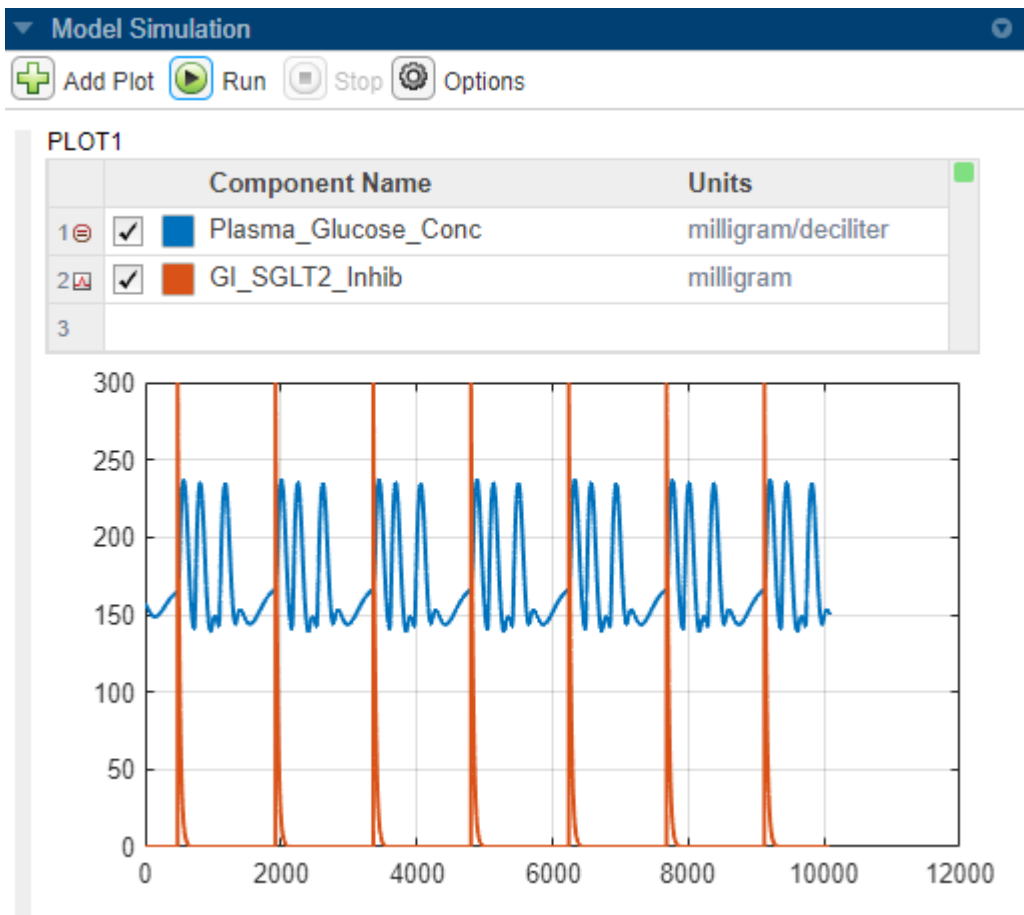

Export Model

SimBiology Model Builder lets you export the model to various file formats. You can:

- Export the model to the MATLAB workspace. Once the model is in the workspace, you can work on it programmatically. For more command-line examples, see “Build and Verify Models”.
- Export the model to an SBML file.
- Generate a model report on page 1-121 that summarizes the various details of the model.
- Export just the model diagram.
- Export the model components to Excel® files.

On the **Home** tab, in the **Model** section, select **Export**.

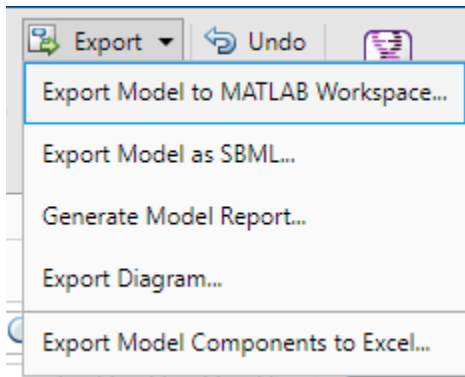

Tip You can find the completed model for this example in `matlabroot\examples\simbio\data\SGLT2_model.sbproj`, where `matlabroot` is the folder where you installed MATLAB.

References

- [1] Dalla Man, Chiara, Robert A. Rizza, and Claudio Cobelli. "Meal Simulation Model of the Glucose-Insulin System." *IEEE Transactions on Biomedical Engineering* 54, no. 10 (October 2007): 1740-49. <https://ieeexplore.ieee.org/document/4303268>.
- [2] Dalla Man, Chiara, M. Camilleri, and C. Cobelli. "A System Model of Oral Glucose Absorption: Validation on Gold Standard Data." *IEEE Transactions on Biomedical Engineering* 53, no. 12 (December 2006): 2472-78. <https://ieeexplore.ieee.org/document/4015600>.
- [3] Wright, Ernest M., Donald D. F. Loo, and Bruce A. Hirayama. "Biology of Human Sodium Glucose Transporters." *Physiological Reviews* 91, no. 2 (April 2011): 733-94. <https://journals.physiology.org/doi/full/10.1152/physrev.00055.2009>.

See Also

SimBiology Model Analyzer | **SimBiology Model Builder**

More About

- "Create Model of Receptor-Ligand Kinetics" on page 1-11
- "SimBiology Apps"

Find Important Parameters with Local Sensitivity Analysis Using SimBiology Model Analyzer App

This example shows how to identify important model parameters for a tumor growth model [1]. In this example, you compute local time-dependent sensitivities of tumor growth with respect to model parameters for an anticancer drug.

Tumor Growth Model

The model used in this example is a SimBiology implementation of the pharmacokinetic/pharmacodynamic (PK/PD) model by Simeoni et al. It quantifies the effect of anticancer drugs on tumor growth kinetics from *in vivo* animal studies. The drug pharmacokinetics are described by a two-compartment model with IV bolus dosing and linear elimination (ke) from the *Central* compartment. Tumor growth is a biphasic process with an initial exponential growth followed by linear growth. The growth rate of the proliferating tumor cells is described by

$$\frac{L_0 * x_1}{\left[1 + \left(\frac{L_0}{L_1} * w\right)^\Psi\right]^{1/\Psi}}$$

L_0 , L_1 , and Ψ are tumor growth parameters, x_1 is the weight of the proliferating tumor cells, and w is the total tumor weight. In the absence of any drugs, the tumor consists of proliferating cells only, that is, $w = x_1$. In the presence of an anticancer agent, a fraction of the proliferating cells is transformed into nonproliferating cells. The rate of this transformation is assumed to be a function of the drug concentration in the plasma and an efficacy factor k_2 . The nonproliferating cells x_2 go through a series of transit stages (x_3 and x_4) and are eventually cleared from the system. The flow-through of the transit compartments is modeled as a first-order process with the rate constant k_1 .

The SimBiology model makes these adjustments to the pharmacodynamics of tumor growth:

- Instead of defining the tumor weight as the sum of x_1 , x_2 , x_3 , and x_4 , the model defines the tumor weight by the reaction named *Increase*, $\text{null} \rightarrow \text{tumor_weight}$, with the reaction rate $\left(2 * L_1 * L_0 * x_1^2 / L_1 + 2 * L_0 * x_1\right) * \text{tumor_weight}$.

tumor_weight is the total tumor weight, x_1 is the weight of the proliferating tumor cells, and L_0 , and L_1 are tumor growth parameters.

- Similarly, the model defines the decrease in tumor weight by the reaction named *Decay*, $\text{tumor_weight} \rightarrow \text{null}$, with the reaction rate $k_1 * x_4$. The constant k_1 is the forward rate parameter, and x_4 is the last species in the series of transit reductions in tumor weight.
- ke is a function of the clearance and the volume of the central compartment: $ke = \text{Cl_Central} / \text{Central}$.

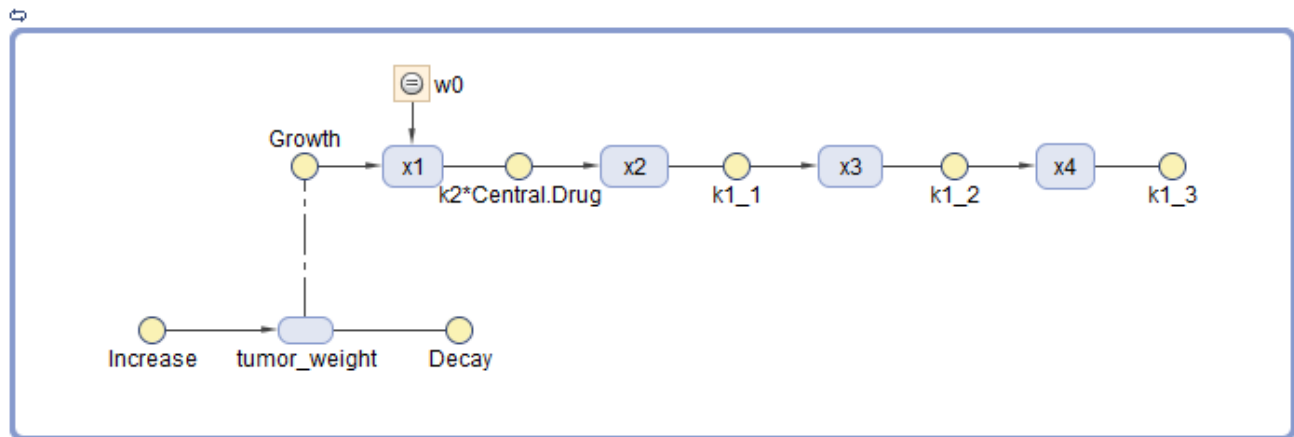
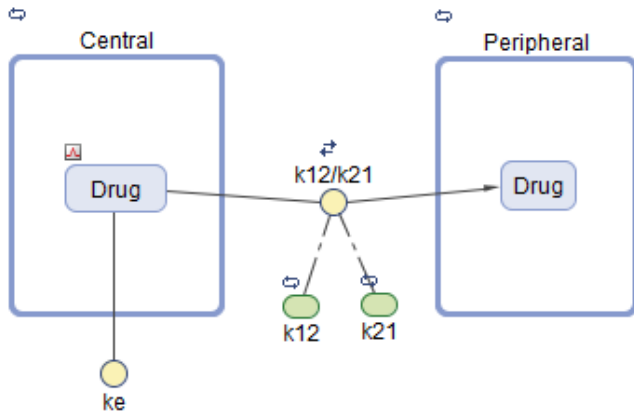

Tumor Growth Model

Sensitivity Analysis

Sensitivity analysis on page 4-19 lets you determine which rate constants and concentrations in a model have significant influence on the overall behavior of the model. This example shows how to investigate which model parameters are sensitive to the tumor growth using the built-in sensitivity analysis program. Specifically, this example shows you how to calculate the sensitivity of *tumor_weight* species with respect to the model parameters as follows:

$$\frac{\partial(\text{tumor_weight})}{\partial(L_0)}, \frac{\partial(\text{tumor_weight})}{\partial(L_1)}, \frac{\partial(\text{tumor_weight})}{\partial(k_1)}, \dots$$

Calculate Sensitivities

Suppose that you have already calibrated tumor growth model parameters on page 1-77 to experimental PK/PD data and saved parameter estimates and initial conditions as a variant called *parameterEstimates* in your model. As a follow-up analysis, you want to find out which model parameters are sensitive to tumor growth. The following steps show how to do so using the built-in sensitivity analysis program.

Load Tumor Growth Model

- 1 At the MATLAB command line, load the model (*m1*) by entering:

```
sbioloadproject tumor_growth_vpop_sa.sbproj
```

- 2 Open the model in the **SimBiology Model Analyzer** app by entering:

```
simBiologyModelAnalyzer(m1)
```

Alternatively, you can open the app by clicking **SimBiology Model Analyzer** on the **Apps** tab. Then load the model from the app by selecting **Model** > Import Model from MATLAB.

Configure Calculate Sensitivities Program

- 1 On the **Home** tab, select **Program** > **Calculate Sensitivities**. A new program opens.
- 2 In the **Variants** section of the **Model** step (a *setup* step) of the program, select **parameterEstimates**. This variant contains previously estimated parameter values and initial conditions for the drug.
- 3 In the **Doses** section, select **interval_dose**. This repeat dose applies 30 mg of the drug every 4 days starting at day 7 for a total of five times.
- 4 In the **States To Log** section, select **[Tumor Growth Model].tumor_weight** only.

Tip The context menus of the **Variants**, **Doses** and **States To Log** tables contain options to add the corresponding model components and show the details of these components in the **Model Builder** app. Access the context menu by right-clicking the table.

MODEL

MODEL

Tumor Growth Model

Prepare the model for accelerated simulation

Save the model with the program results. This must be checked for reports to include the model information.

VARIANTS

Use	Name
<input checked="" type="checkbox"/>	parameterEstimates

DOSES

Use	Name	Description
<input type="checkbox"/>	single_dose	Target Name: Central.Drug
<input checked="" type="checkbox"/>	interval_dose	Target Name: Central.Drug

STATES TO LOG

Log all states

Use	Name
<input type="checkbox"/>	Central.Drug
<input type="checkbox"/>	Peripheral.Drug
<input checked="" type="checkbox"/>	[Tumor Growth Model].tumor_weight

- 5 In the **Simulation** step (an *execution* step), by default, the normalization method is set to **Full (full dedimensionalization)**, meaning that the app fully normalize the sensitivities so that they can be compared to each other. For details, see [Normalization](#).

Use the default stop time (40).

Tip You can run every program *execution* step separately. An execution step includes the run button next to the name the step. Running an individual step is especially helpful if the program contains multiple steps and you want to see the intermediate results from a particular step. By doing so, you can make adjustments as needed before running the next step or the whole program. To run the whole program, click the **Run** button on the **Home** tab.

- 6 In the **Sensitivities to Compute** section, right-click anywhere in the table and select **Add All Constant Parameters**. Clear *ke* because it is defined as a function of the *Central* volume and *Cl_Central*, which is already an input. Click the last empty row and type *tumor*. Then select `[Tumor Growth Model].tumor_weight` from the list. The *tumor_weight* species is then added as the output.

SIMULATION

DESCRIPTION
Click to edit the description

STOP TIME
40 day

NORMALIZATION FOR COMPUTED SENSITIVITIES
Full (full dedimensionalization)

SENSITIVITIES TO COMPUTE

Output	Input	Name
<input type="checkbox"/>	<input checked="" type="checkbox"/>	k12
<input type="checkbox"/>	<input checked="" type="checkbox"/>	k21
<input type="checkbox"/>	<input checked="" type="checkbox"/>	L0
<input type="checkbox"/>	<input checked="" type="checkbox"/>	L1
<input type="checkbox"/>	<input checked="" type="checkbox"/>	w0
<input type="checkbox"/>	<input checked="" type="checkbox"/>	k2
<input type="checkbox"/>	<input checked="" type="checkbox"/>	k1
<input type="checkbox"/>	<input type="checkbox"/>	ke
<input type="checkbox"/>	<input checked="" type="checkbox"/>	CI_Central
<input checked="" type="checkbox"/>	<input type="checkbox"/>	[Tumor Growth Model].tumor_weight

Check Initial Conditions

You can view the initial conditions of model quantities, namely compartments, species, and parameters, before simulating a model. The initial conditions are the quantity values at simulation time = 0 after applying the assignment rules, variants, and doses (if any at time = 0). For details, see "Model Simulation" on page 4-3. You can use this information to debug a model and check if the quantity values are initialized as you expect before simulating the model.

- 1 In the **Browser** pane, click **Model**.
- 2 Right-click anywhere within the **Species and Compartments** table or **Parameters** table. Select **Show Model Initial Conditions**.

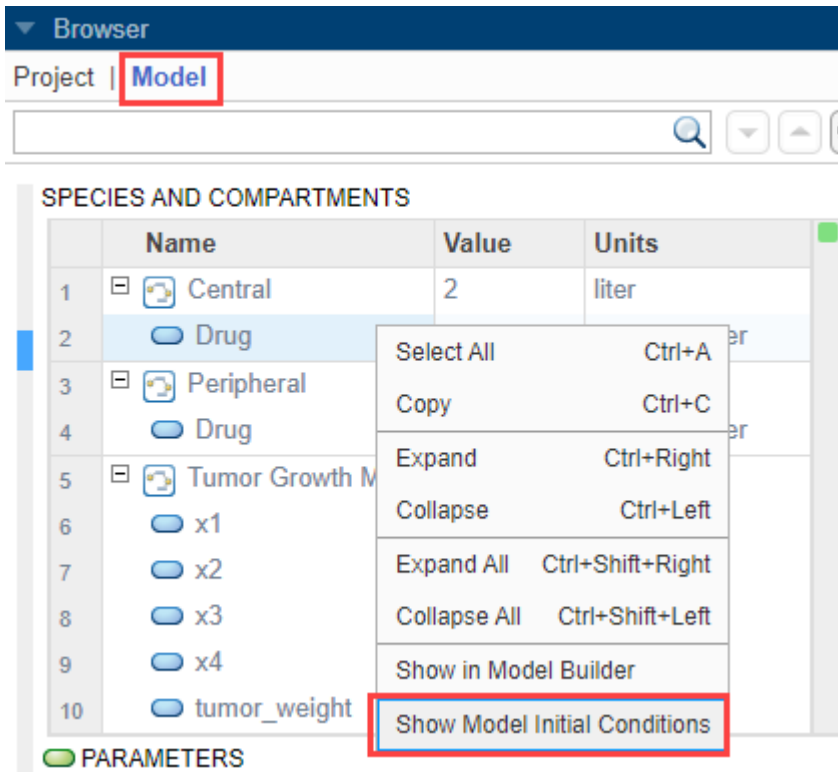

- 3 The app shows the **Initial Condition** column in both quantity tables. These values are what the program uses at time = 0 when you simulate.

Browser

Project | Model

SPECIES AND COMPARTMENTS

	Name	Value	Initial Condition	Units
1	Central	2	2	liter
2	Drug	0	0	milligram/liter
3	Peripheral	1	1	liter
4	Drug	0	0	milligram/liter
5	Tumor Growth Model	1	1	liter
6	x1	0	1	gram
7	x2	0	0	gram
8	x3	0	0	gram
9	x4	0	0	gram
10	tumor_weight	1	1	gram

PARAMETERS

	Name	Value	Initial Condition	Units	Scope
1	k12	0.0115	0.0108	1/hour	model
2	k21	0.0616	0.0588	1/hour	model
3	L0	0.4000	0.5687	1/day	model
4	L1	0.3000	0.2690	gram/day	model
5	w0	1	1	gram	model
6	k2	8.4200e-4	8.4200e-4	milliliter/nanogram/day	model
7	k1	0.5000	0.4643	1/day	model
8	ke	0.5530	0.3336	1/hour	model
9	CI_Central	0.7000	0.6672	liter/hour	model

4 Next, run the program by clicking **Run** on the **Home** tab.

Visualize Sensitivity Results

1 After the sensitivity analysis, the program automatically generates two plot tabs **Plot1** and **Plot2**. Click **Plot1** to view a plot of the time course of the tumor weight and other sensitivity values $d[\text{tumor_weight}]/d[\text{parameter}]$. The time plots for $d[\text{tumor_weight}]/d[\text{k21}]$ and $d[\text{tumor_weight}]/d[\text{k12}]$ stay relatively flat compared to other sensitivities, indicating that

the tumor growth is not sensitive to $k21$ and $k12$ parameters. The **Property Editor** lets you select which plots to display.

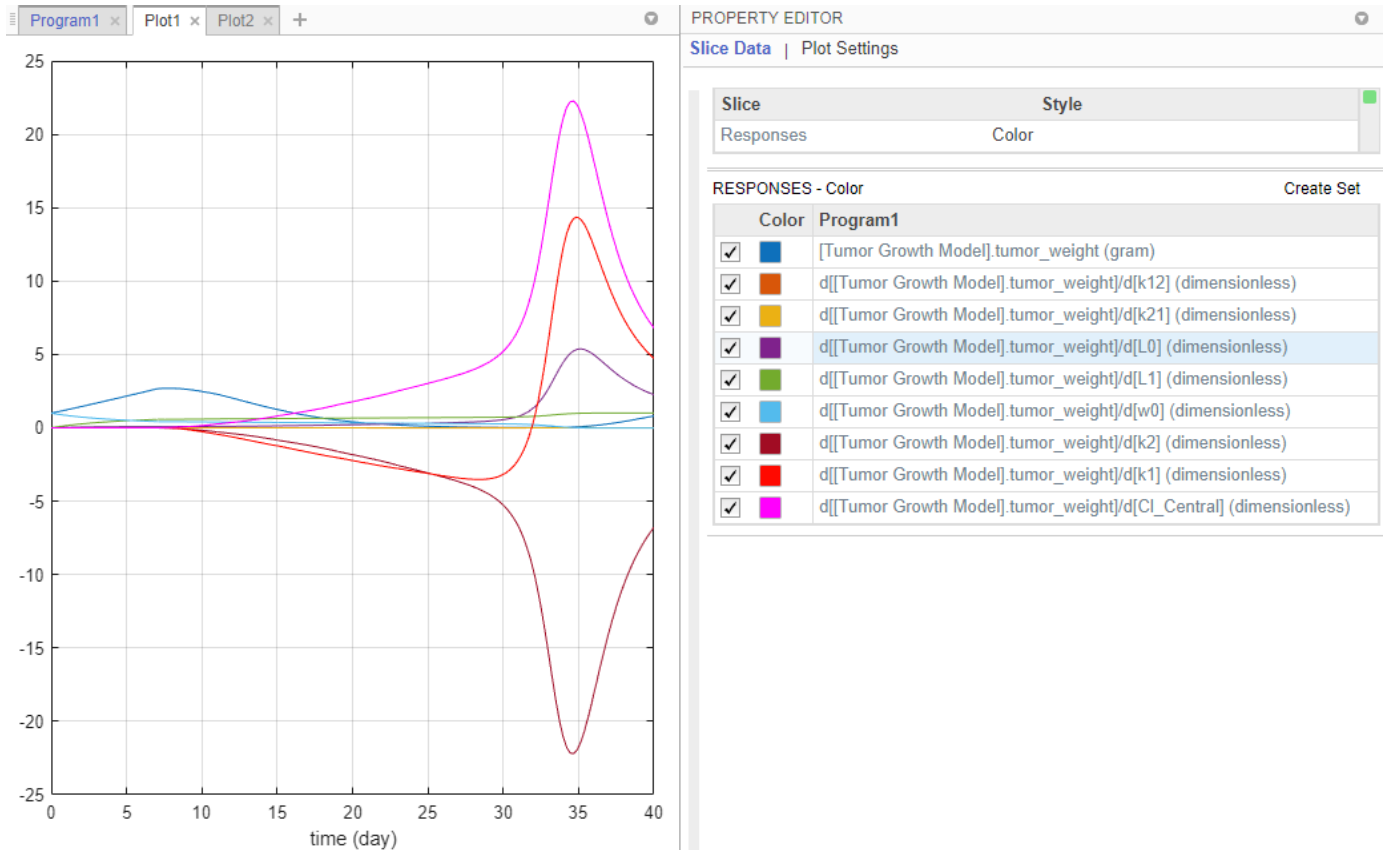

Tip Plots are backed by data that are currently present in the app workspace. Plots are not snapshots. When the data (either experimental data or simulation results) is removed or changed, the plots are also updated according to the changes in the underlying data.

- You can also examine the same sensitivity data by checking the magnitude of the computed sensitivities integrated over time. The second generated plot (**Plot2**) shows a bar plot containing such information. The plot shows that the tumor weight is sensitive to $L0$, $L1$, $w0$, $k2$, $k1$, and $Cl_Central$, but not to $k12$ and $k21$.

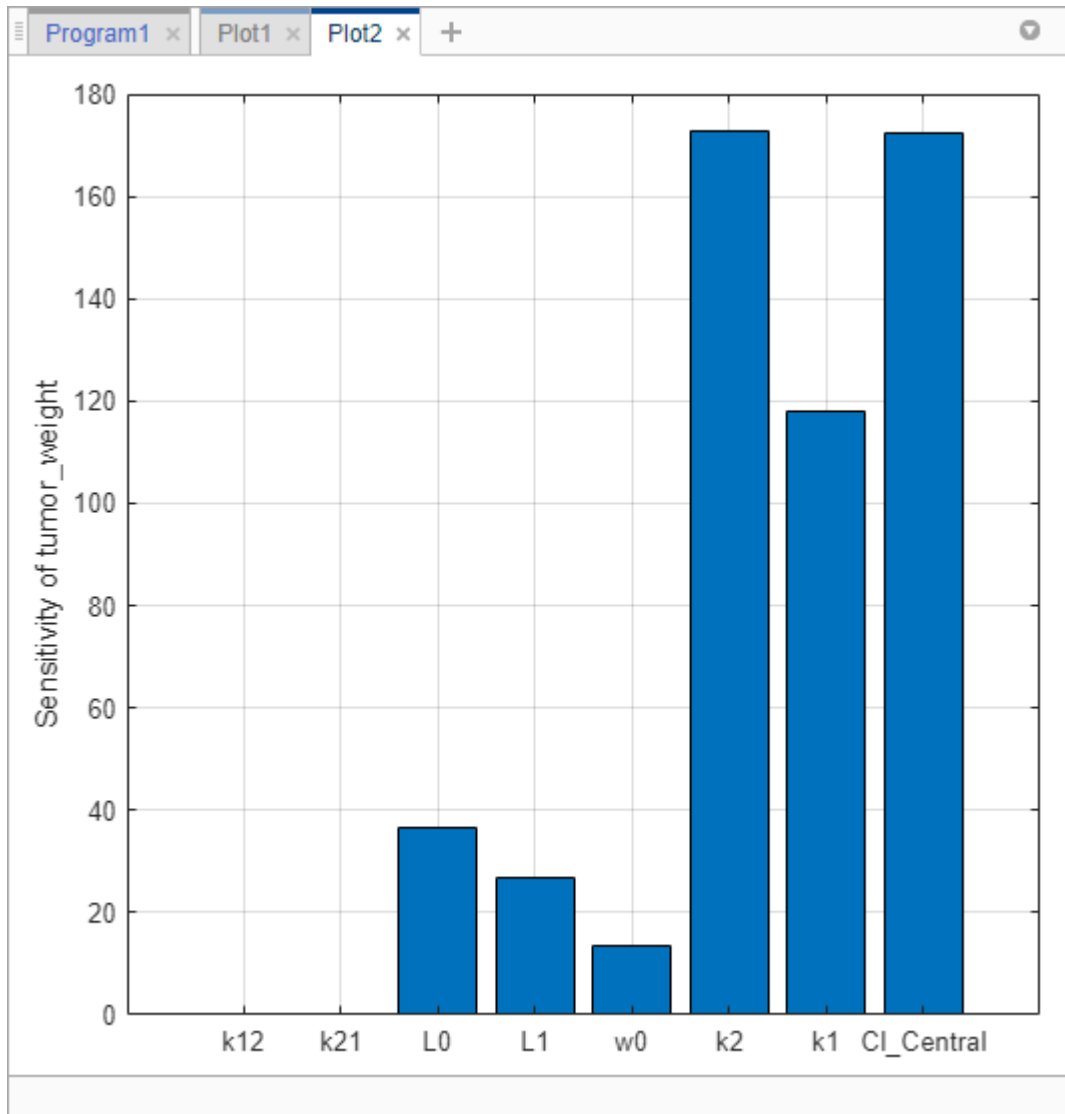

- 3 Save the sensitivity analysis results in a separate folder.
 - a Click **Project** in the **Browser** pane. Expand the **Program1** folder.
 - b Right-click the **LastRun** folder. Select **Save Data**.
 - c In the **Save Data** dialog, enter `sa_data` as the data name.

Investigate Variability of $k12$ and $k21$

The sensitivity analysis results indicate that tumor weight is not sensitive to the model values of $k12$ and $k21$. Explore whether varying these parameter values results in different sensitivity results.

Vary $k12$

First, vary values for the $k12$ parameter.

- 1 Click the **Program1** tab. Click the (+) plus at the top of the program and select **Generate Samples**.

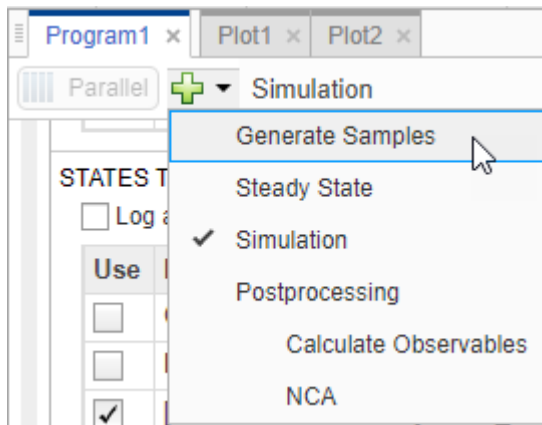

- 2 The **Generate Samples** step appears. Disable the default plot generation by clicking the plot button at the top of the step.



- 3 In the **Parameter Set** section of the step, double-click the empty cell in the **Component Name**, and enter k_{12} . Set the following options:
 - **Type** — Range Of Values
 - **Spacing** — linear
 - **Min** — $1e-3$
 - **Max** — 1
 - **# Of Steps** — 25

 GENERATE SAMPLES

DESCRIPTION
Click to edit the description

PARAMETER SET : Quantity

Name = PS1
Type = user defined values
Parameter Combination = elementwise (25)

Use	Component Name	Current Value
<input checked="" type="checkbox"/>	<div style="border: 1px solid red; padding: 2px;"> k12 Type = Range Of Values Spacing = linear Min = 1.0000e-3 Max = 1 # Of Steps = 25 </div>	0.0108

- 4 In the **Simulation** step, under **Sensitivities to Compute**, clear all the inputs except *k12*. Keep *tumor_weight* as the output. Also, disable the default plot generation by clicking the plot button at the top of the step.

 **SIMULATION**

DESCRIPTION
 Click to edit the description

STOP TIME
 40 day

NORMALIZATION FOR COMPUTED SENSITIVITIES
 Full (full dedimensionalization)

SENSITIVITIES TO COMPUTE

Output	Input	Name
<input type="checkbox"/>	<input checked="" type="checkbox"/>	k12
<input type="checkbox"/>	<input type="checkbox"/>	k21
<input type="checkbox"/>	<input type="checkbox"/>	L0
<input type="checkbox"/>	<input type="checkbox"/>	L1
<input type="checkbox"/>	<input type="checkbox"/>	w0
<input type="checkbox"/>	<input type="checkbox"/>	k2
<input type="checkbox"/>	<input type="checkbox"/>	k1
<input type="checkbox"/>	<input type="checkbox"/>	ke
<input type="checkbox"/>	<input type="checkbox"/>	CI_Central
<input checked="" type="checkbox"/>	<input type="checkbox"/>	[Tumor Growth Model].tumor_weight

 *Disable sensitivity calculation*

- 5 On the **Home** tab, click the **Run** button to run the whole program.
- 6 Once the simulation finishes, the sensitivity **results** are stored in the **LastRun** folder. Expand the **LastRun** folder. Click **results**. Then select **time** from the **Plot** section on the **Home** tab.

The **Responses** in the plot correspond to the tumor weight and the sensitivity of the tumor weight with respect to $k12$. Each response is plotted using a different line style. The **Scenarios** correspond to each parameter scan (simulation scenario). Each scenario is plotted using a different color.

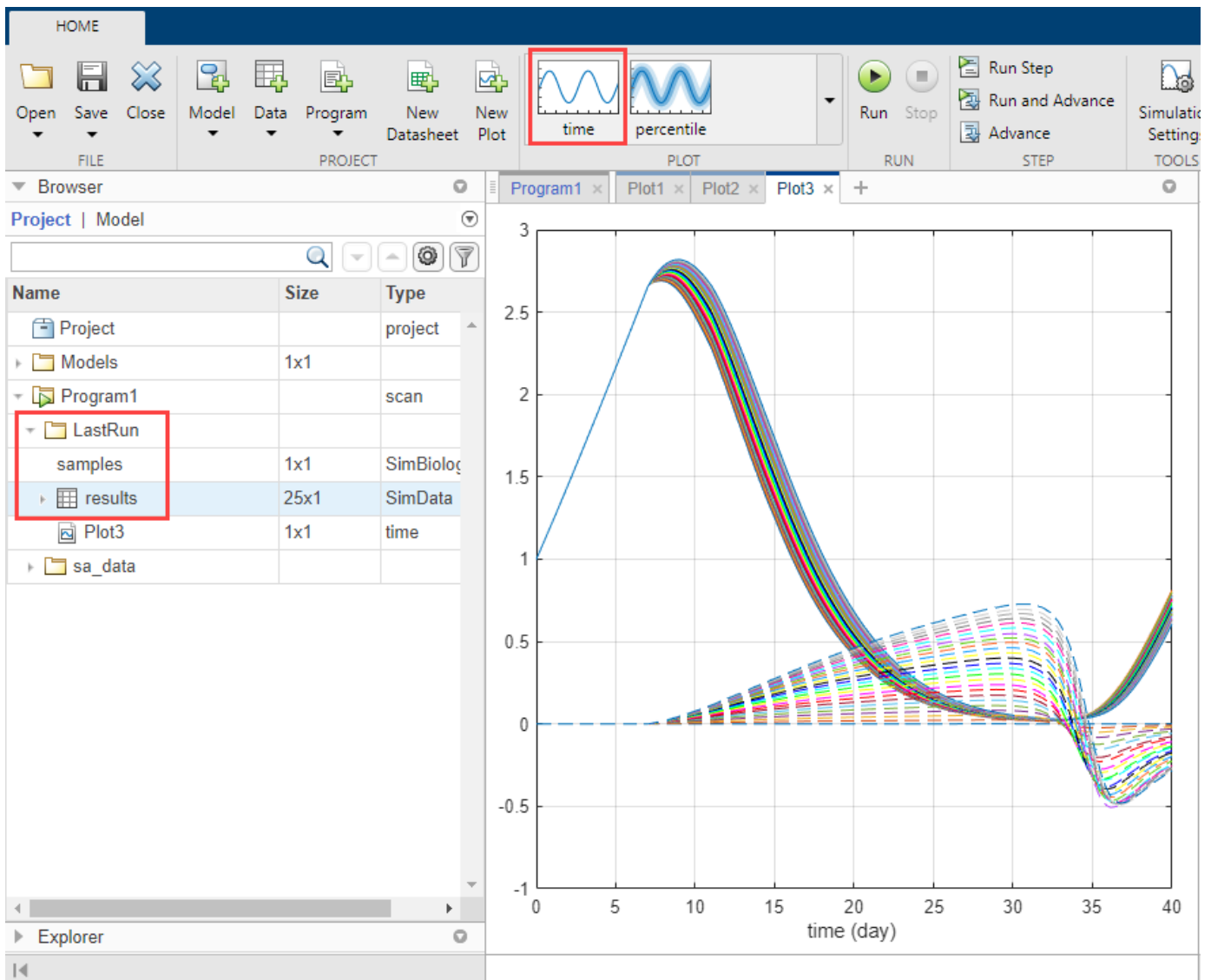

- 7 Customize the plot so that the plot uses a different color for each response instead. In the **Slice Data** table, clear the **Style** of **Scenarios** by selecting empty. Set **Responses** to **Color**.
- 8 In the **Responses** table, clear tumor_weight and keep only the sensitivity results.

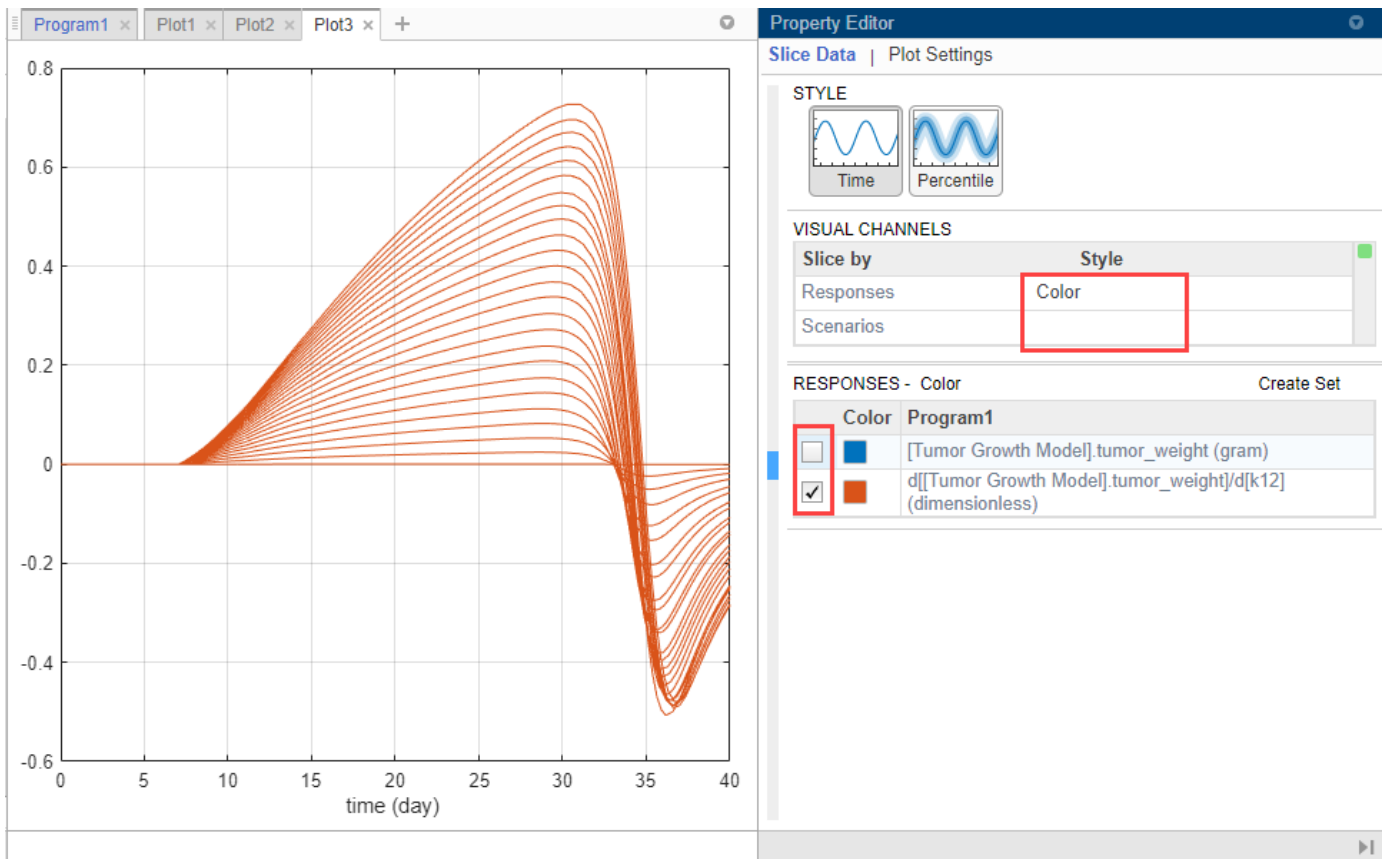

The plot suggests that the tumor weight is sensitive to some k_{12} parameter values when model variants different than the estimated parameter values are explored.

- 9 Plot the k_{12} sensitivities together with the previous sensitivity results to see how sensitive the tumor growth is to k_{12} relative to other model parameters. In the **Browser** pane, expand the folder **sa_data** that you saved previously. Then expand **results**.
- 10 Multiselect (**Shift + Click**) the sensitivity data entries for L_0 , L_1 , w_0 , k_2 , k_1 , and $Cl_Central$. Then drag them on to the k_{12} sensitivity plot **Plot3**.

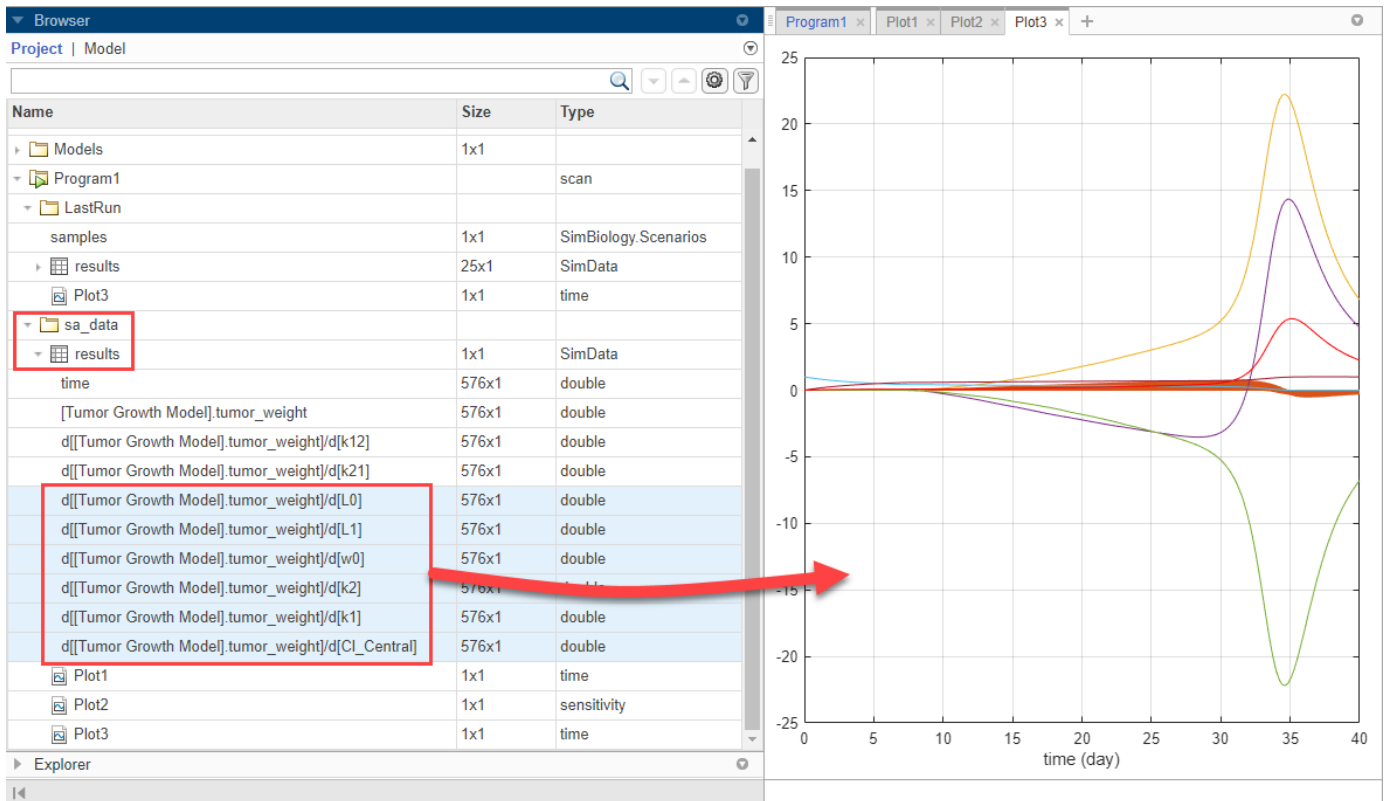

The plot suggests that the tumor growth is still more sensitive to most of the other parameters than k_{12} .

- 11 Save the results in a separate folder. Right-click **LastRun** and select **Save Data**. Enter k_{12_data} as the data name.

Vary k_{21}

You can perform a similar analysis by varying k_{21} and comparing its results with other parameter sensitivities.

- 1 Return to **Program1**. In the **Generate Samples** step, click **Add parameter set to scan**. A new **Parameter Set** section appears.
- 2 Double-click the empty cell in the **Component Name**, and enter k_{21} . Set the same options as k_{12} :
 - **Type** — Range of Values
 - **Spacing** — linear
 - **Min** — $1e-3$
 - **Max** — 1
 - **# Of Steps** — 25

PARAMETER SET : Quantity

Name = PS2
 Type = user defined values
 Parameter Combination = elementwise (25)

Use	Component Name	Current Value
<input checked="" type="checkbox"/>	k21 Type = Range Of Values Spacing = linear Min = 1.0000e-3 Max = 1 # Of Steps = 25	0.0588

- 3 Disable the first parameter set (**PS1**). Point to the top corner of **Parameter Set** section of **PS1** and click the action button. Then select **Disable Parameter Set**.

PARAMETER SET : Quantity

Name = PS1
 Type = user defined values
 Parameter Combination = elementwise (25)

Add Parameter Set
 Disable Parameter Set
 Delete Parameter Set

Use	Component Name	Current Value
<input checked="" type="checkbox"/>	k12 Type = Range Of Values	0.0115

The **Parameter Set** is then grayed out to indicate you have successfully disabled it.

PARAMETER SET : Quantity

Name = PS1
Type = user defined values
Parameter Combination = elementwise (25)

Use	Component Name	Current Value
<input checked="" type="checkbox"/>	<input type="checkbox"/> k12	0.0108
	Type = Range Of Values	
	Spacing = linear	
	Min = 1.0000e-3	
	Max = 1	
	# Of Steps = 25	

- 4 In the **Simulation** step, select *k21* as the only input and *tumor_weight* as the output.
- 5 Hit **Run** from the **Home** tab to run the program again.
- 6 Once the simulation finishes, the results are automatically plotted in a new plot tab.

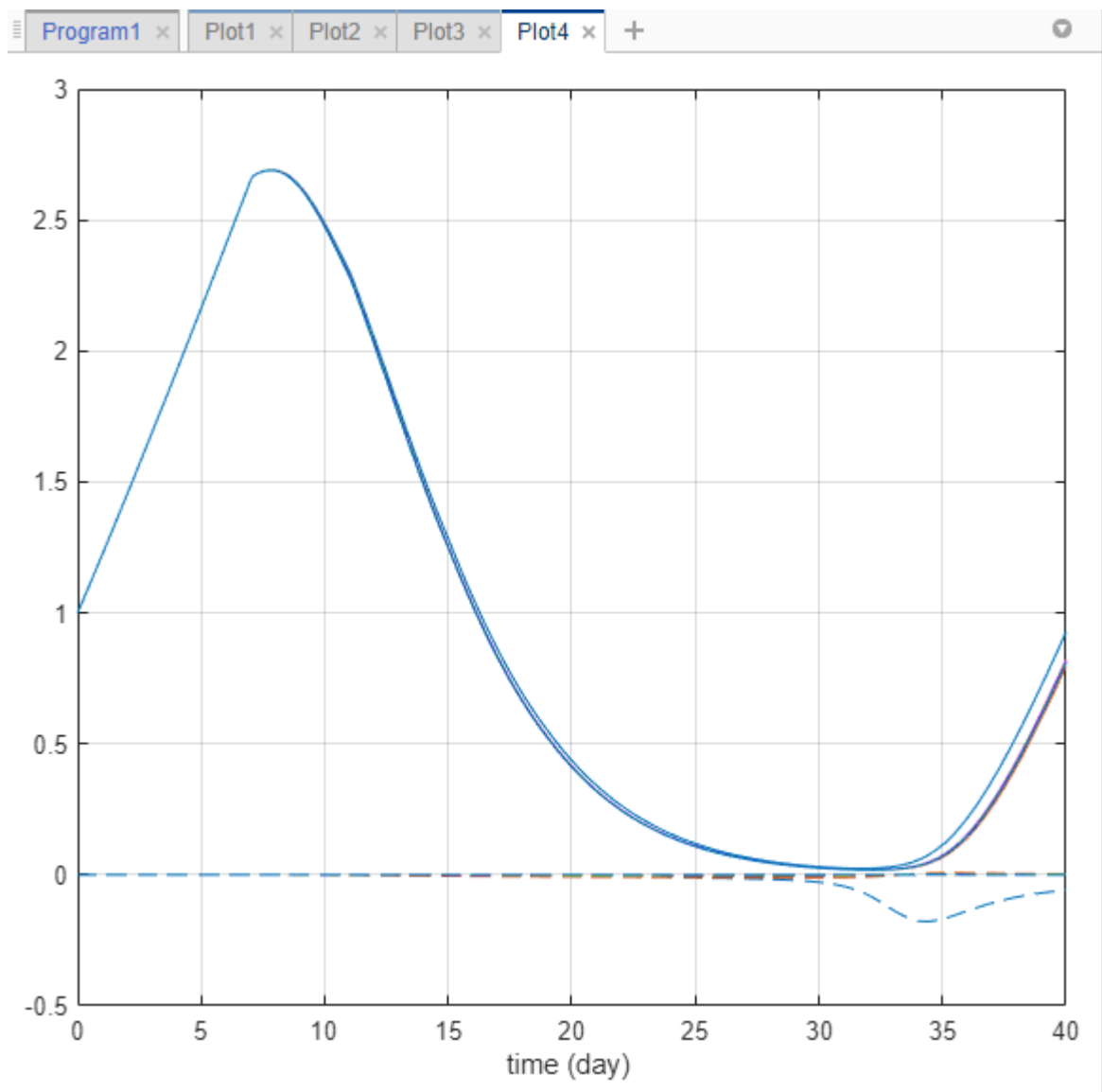

- 7 In the **Slice Data** table, clear the **Style** of **Scenarios** by selecting empty. Set **Responses** to **Color**.
- 8 In the **Responses** table, clear `tumor_weight` and keep only the sensitivity results.

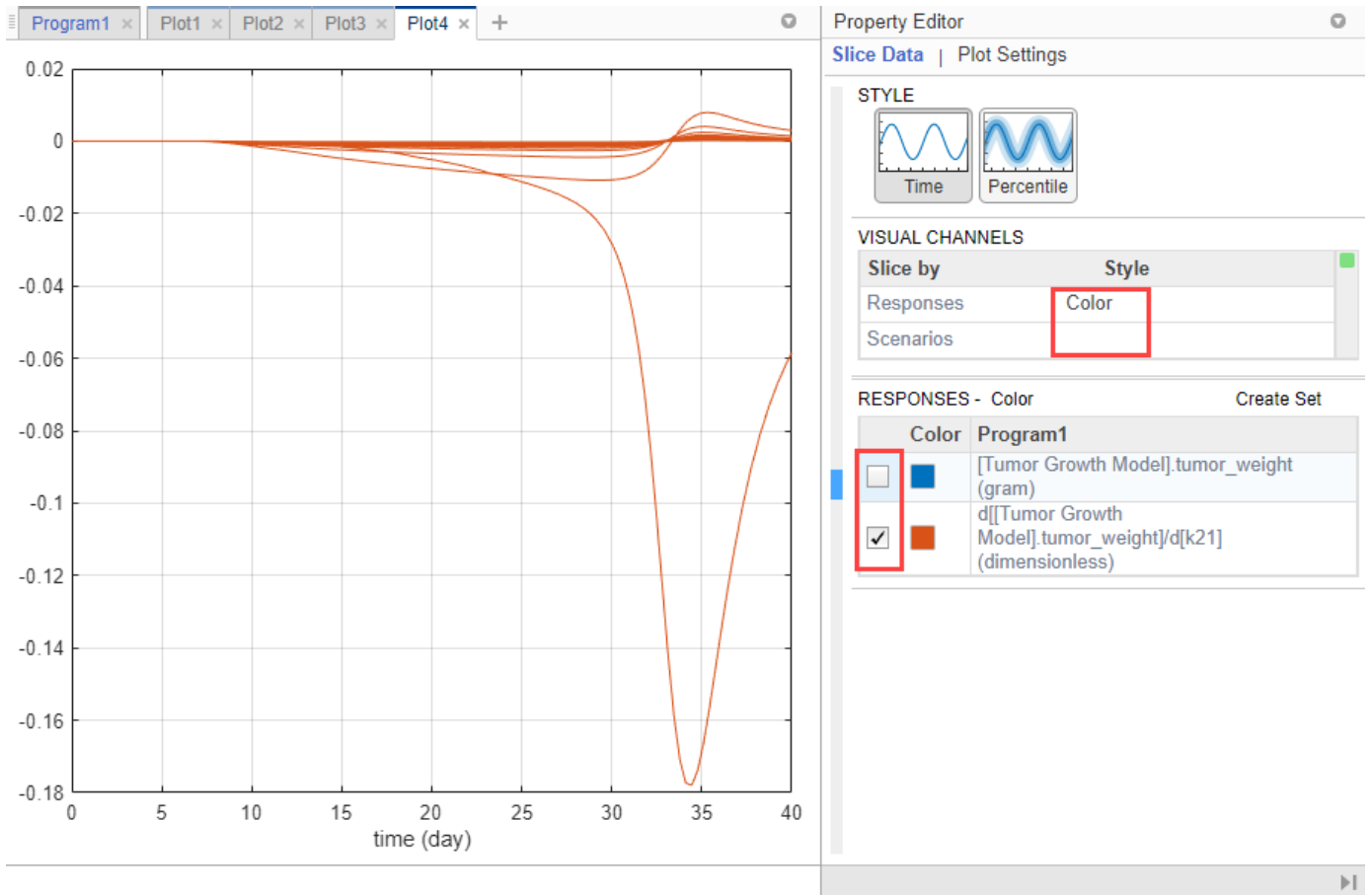

The plot suggests that the tumor weight is sensitive to some $k21$ parameter values when model variants different than the estimated parameter values are explored.

- 9 Plot $k21$ sensitivities together with the previous sensitivity results to compare. Click **Plot3**. In the **Browser** pane, expand the **LastRun** folder. Then expand **results**.
- 10 Drag the $k21$ sensitivity data `d[[Tumor Growth Model].tumor_weight]/d[k21]` on to **Plot3**.

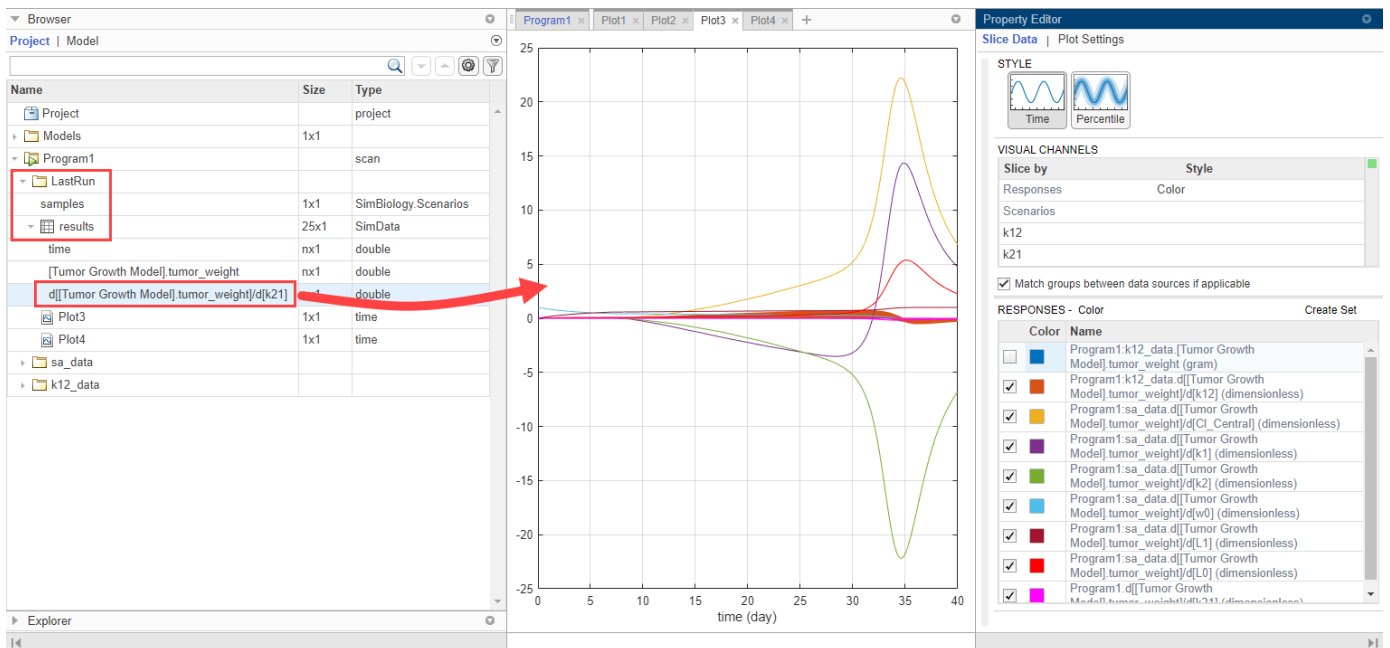

The plot suggests that the tumor growth is relatively more sensitive to most other parameters than $k21$ and $k12$.

This example shows how to perform sensitivity analysis to find important model parameters to which tumor growth is sensitive. The initial analysis concludes that the tumor weight is not sensitive to some of the parameters. The example then explores the parameter space of these less sensitive parameters and compares the sensitivity results with those of other model parameters. You can use such sensitivity information for other analyses, such as to perform Monte Carlo simulations on page 1-61 by varying sensitive parameters to explore the model dynamics and biological variability.

References

- [1] Simeoni, M., P. Magni, C. Cammia, G. De Nicolao, V. Croci, E. Pesenti, M. Germani, I. Poggesi, and M. Rocchetti. 2004. Predictive pharmacokinetic-pharmacodynamic modeling of tumor growth kinetics in xenograft models after administration of anticancer agents. *Cancer Research*. 64:1094-1101.

See Also

simbiology | **SimBiology Model Analyzer**

More About

- “Calculate NCA Parameters and Fit Model to PK/PD Data Using SimBiology Model Analyzer App” on page 1-77
- “Model Biological Variability with Virtual Patients Using SimBiology Model Analyzer App” on page 1-61
- “Scan Dosing Regimens Using SimBiology Model Analyzer App” on page 1-108

Model Biological Variability with Virtual Patients Using SimBiology Model Analyzer App

This example shows how to generate and simulate virtual patients using the **SimBiology Model Analyzer** app. In this example, a virtual patient is represented as a single realization of model parameters. The example uses a tumor growth model [1] to explore the variability of some model parameters that influence the tumor growth and investigate various dosing regimens to control it.

This example requires Statistics and Machine Learning Toolbox™.

Tumor Growth Model

The model used in this example is a SimBiology implementation of the pharmacokinetic/pharmacodynamic (PK/PD) model by Simeoni et al. It quantifies the effect of anticancer drugs on tumor growth kinetics from *in vivo* animal studies. The drug pharmacokinetics are described by a two-compartment model with IV bolus dosing and linear elimination (ke) from the *Central* compartment. Tumor growth is a biphasic process with an initial exponential growth followed by linear growth. The growth rate of the proliferating tumor cells is described by

$$\frac{L_0 * x_1}{\left[1 + \left(\frac{L_0}{L_1} * w\right)^\Psi\right]^{1/\Psi}}$$

L_0 , L_1 , and Ψ are tumor growth parameters, x_1 is the weight of the proliferating tumor cells, and w is the total tumor weight. In the absence of any drugs, the tumor consists of proliferating cells only, that is, $w = x_1$. In the presence of an anticancer agent, a fraction of the proliferating cells is transformed into nonproliferating cells. The rate of this transformation is assumed to be a function of the drug concentration in the plasma and an efficacy factor k_2 . The nonproliferating cells x_2 go through a series of transit stages (x_3 and x_4) and are eventually cleared from the system. The flow-through of the transit compartments is modeled as a first-order process with the rate constant k_1 .

The SimBiology model makes these adjustments to the pharmacodynamics of tumor growth:

- Instead of defining the tumor weight as the sum of x_1 , x_2 , x_3 , and x_4 , the model defines the tumor weight by the reaction named *Increase*, `null → tumor_weight`, with the reaction rate $\left(2 * L_1 * L_0 * x_1^2 / L_1 + 2 * L_0 * x_1\right) * tumor_weight$.

$tumor_weight$ is the total tumor weight, x_1 is the weight of the proliferating tumor cells, and L_0 , and L_1 are tumor growth parameters.

- Similarly, the model defines the decrease in tumor weight by the reaction named *Decay*, `tumor_weight → null`, with the reaction rate $k_1 * x_4$. The constant k_1 is the forward rate parameter, and x_4 is the last species in the series of transit reductions in tumor weight.
- ke is a function of the clearance and the volume of the central compartment: $ke = Cl_Central / Central$.

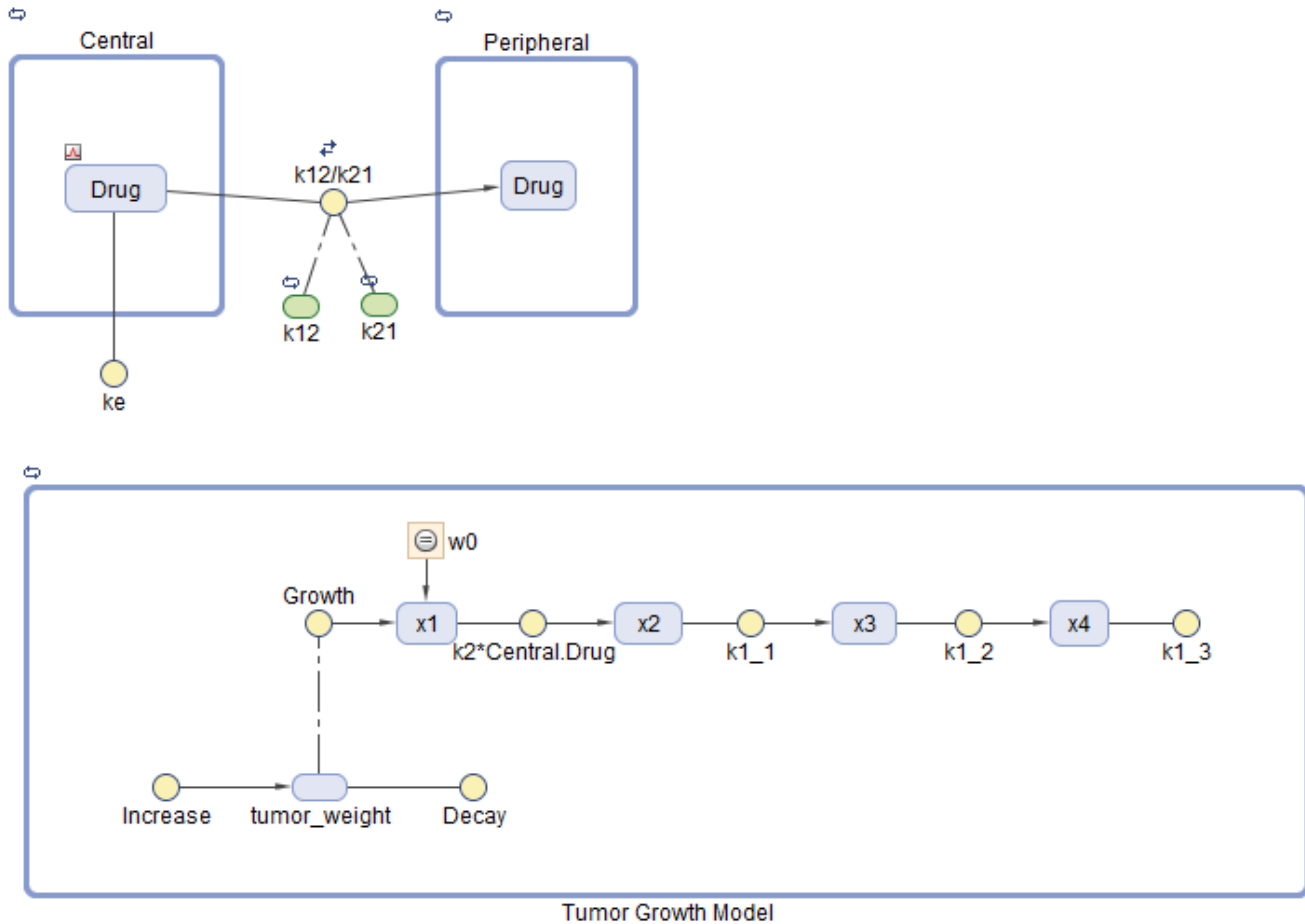

Description of Virtual Population

The virtual population in this example is represented by virtual patients, specified as distinct sets of patient-specific parameter values. Suppose that, based on prior knowledge or sensitivity analysis on page 1-41 of the model, the tumor growth is sensitive to these model parameters: $L0$, $L1$, $w0$, $k1$, $k2$, and $Cl_{Central}$. Assuming that these biological parameters follow the lognormal distribution (and must always be positive), you can generate virtual patients that represent different parameter values drawn from the joint lognormal distribution.

The lognormal distribution uses these parameters:

- μ - Mean of logarithmic values
- σ - Standard deviation of logarithmic values

For details, see “Lognormal Distribution” (Statistics and Machine Learning Toolbox).

In this example, σ is assumed to be 0.01 for all the parameters. For a small σ value, the mean of a lognormal distribution is approximately equal to the log of the model value. Hence, this example assumes that μ for each parameter is the log of the model value.

Dosing Strategies

In this example, an anticancer drug is used to control the tumor growth. Each virtual patient receives the same amount of the drug on the same schedule. The tumor growth response is simulated for each patient. Dose amounts are then varied to find the range of dose amounts that can suppress the tumor growth of many virtual patients in the population.

Generate Samples to Represent Virtual Patients

The following steps show how to draw sample values from the joint probability distribution for model parameters that are sensitive to tumor growth. These sample values represent virtual patients.

Load Tumor Growth Model

- 1 At the MATLAB command line, load the model (*m1*) by entering:

```
sbioloadproject tumor_growth_vpop_sa.sbproj
```

- 2 Open the model in the **SimBiology Model Analyzer** app by entering:

```
simBiologyModelAnalyzer(m1)
```

Alternatively, you can open the app by clicking **SimBiology Model Analyzer** on the **Apps** tab. Then load the model from the app by selecting **Model > Import Model** from MATLAB.

Define Joint Probability Distribution

Create a program to draw sample values from the joint lognormal distribution for tumor growth sensitive parameters: *L0*, *L1*, *w0*, *k1*, *k2*, and *Cl_Central*.

- 1 On the **Home** tab, select **Program > Generate Samples**. A new program opens.
- 2 In the **Variants** section in the **Model** step of the program, click the option to view the variants to be applied. Then select **parameterEstimates**, which contains the estimated parameter values.
- 3 Keep the **Doses** section as is so that no doses are selected.
- 4 In the **Generate Samples** step, click the plot button to disable default plot generation. You will plot the samples later on.



- 5 In the **Parameter Set** section, set **Type** to values from a distribution.
- 6 Set **Number Of Samples** to 25.
- 7 Double-click the empty cell in the **Component Name** column, and enter **L0**.
- 8 Change **Distribution** for **L0** to Lognormal. By definition, *mu* is the mean of logarithmic values. So, change *mu* to -0.5644, which is $\log(\text{Current Value})$ or $\log(0.5687)$. Change *sigma* to 0.01. For a small *sigma* value, the mean of a lognormal distribution is approximately equal to $\log(\text{Current Value})$. For details, see “Lognormal Distribution” (Statistics and Machine Learning Toolbox).
- 9 Double-click the empty cell in the **Component Name** column, and add *L1*. Repeat the same process to change the distribution to lognormal and set the *mu* and *sigma* values. Similarly, add

w_0 , k_1 , k_2 , and k_e . This table lists the corresponding μ values of these parameters that you can copy and paste in the software. Change σ to 0.01 for each parameter.

Parameter	Current Value	μ or Log(Current Value)
L0	0.5687	-0.5644
L1	0.2690	-1.3130
w0	1	0
k1	0.4643	-0.7672
k2	8.4200e-4	-7.0797
Cl_Central	0.6672	-0.4047

- 10** For **Sampling**, use the default option: random sampling with rank correlation matrix, where the matrix is an identity matrix.

The following figure shows the **Parameter Set** section with all parameters configured.

PARAMETER SET : Quantity

Name = PS1
 Type = values from a distribution
 Number Of Samples = 25
 Parameter Combination = elementwise (25)

Use	Component Name	Current Value
<input checked="" type="checkbox"/>	<input type="checkbox"/> L0 Distribution = Lognormal mu = -0.5644 sigma = 0.0100	0.5687
<input checked="" type="checkbox"/>	<input type="checkbox"/> L1 Distribution = Lognormal mu = -1.3130 sigma = 0.0100	0.2690
<input checked="" type="checkbox"/>	<input type="checkbox"/> w0 Distribution = Lognormal mu = 0 sigma = 0.0100	1
<input type="checkbox"/>	<input type="checkbox"/> L1	0.4643

SAMPLING OPTIONS

Type = random sampling with rank correlation matrix

Correlation Matrix

	L0	L1	w0	k1	k2	CI_Central
L0	1	0	0	0	0	0
L1	0	1	0	0	0	0
w0	0	0	1	0	0	0
k1	0	0	0	1	0	0
k2	0	0	0	0	1	0
CI_Central	0	0	0	0	0	1

- 11** (Optional) Save the project under a new name by selecting **Save > Save Project As** on the **Home** tab.

Define Dosing Strategies

Add the dosing information as another parameter set by specifying different dose amount—specifically, six dose amounts that are equally spaced from 5 to 35 mg. Then combine the doses with the first parameter set (virtual patients) using the Cartesian combination method. This method combines every virtual patient with every dose amount to generate a total of 150 iterations (or simulation scenarios). For details, see “Combine Simulation Scenarios in SimBiology” on page 3-23.

- 1 At the bottom of the **Generate Samples** step, click **Add parameter set to scan**. Another parameter set (**PS2**) appears.
- 2 Double-click the empty cell in the **Component Name** column, and type `interval`. A list of choices appears. Select `interval_dose.Amount`.
- 3 Set **Type** to `Individual Values` and set **Values** to `[5:6:35]`.

PARAMETER SET : Quantity

Name = PS2

Type = user defined values

Parameter Combination = elementwise (6)

Use	Component Name	Current Value
<input checked="" type="checkbox"/>	<div style="border: 1px solid #ccc; padding: 2px;"> <div style="display: flex; justify-content: space-between;"> interval_dose.Amount 30 </div> <div style="margin-top: 5px;"> Type = Individual Values Values = [5:6:35] </div> </div>	30

- 4 Near the top of the **Generate Samples** step, under **Parameter Set Combinations**, ensure that the **Combination** type is set to `cartesian` to combine PS1 and PS2.

PARAMETER SET COMBINATIONS

Number of Iterations: 150

Sampling Data	Combination
SD1 (150)	= PS1 (25) cartesian elementwise PS2 (6)

PARAMETER SET : Quantity

Name = PS1

Type = values from a distribution

Generate and Visualize Parameter and Dose Combinations

Once you have defined the joint lognormal distribution for model parameters, range of dose amounts, and the combination method, you can run the step to generate the different parameters and dose combinations.

- 1 Click the **Run this program step** button to generate samples.

GENERATE SAMPLES

DESCRIPTION

[Click to edit the description](#)

Tip You can run every program *execution* step separately. An execution step includes the run button next to the name the step. Running an individual step is especially helpful if the program

contains multiple steps and you want to see the intermediate results from a particular step. By doing so, you can make adjustments as needed before running the next step or the whole program. To run the whole program, click the **Run** button on the **Home** tab.

By default, the app stores the generated **samples** in the **LastRun** folder of the program.

- 2 Visualize the generated samples. In the **Browser** pane on the left, expand the **Program1** folder. Expand the **LastRun** folder, and then click **samples**. In the **Plot** section on the **Home** tab, click **Plot Matrix**. The plot shows the distribution of each parameter varied around its model value, except the dose amounts, which appear in a uniform range. Note that your plot might vary from the plot shown here due to randomness.

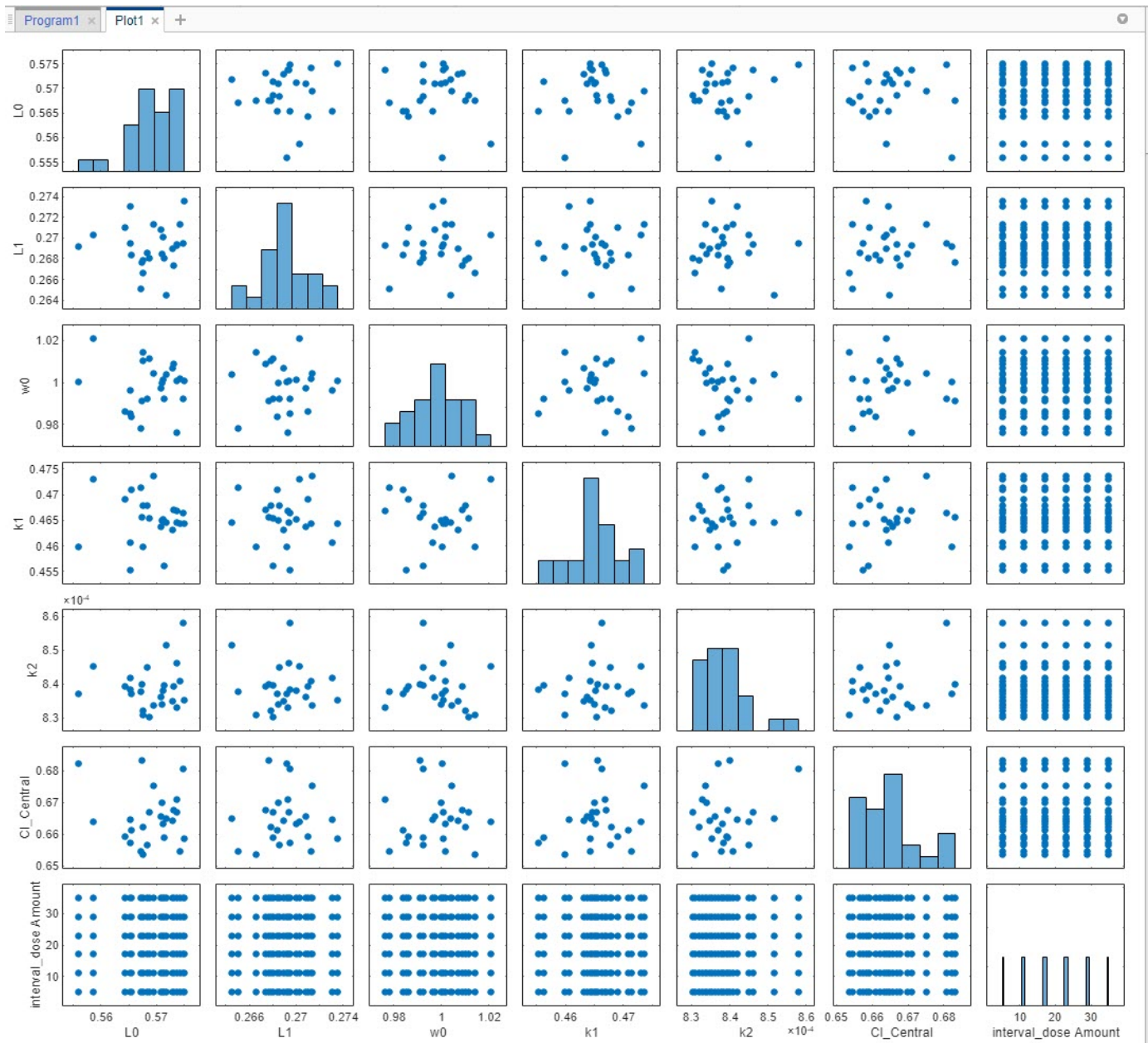

Note You can enable default plot generation to display the plot automatically every time you run the step. To do so, click the plot button at the top of the **Generate Samples** step. Keep in mind that when the program step has a lot of samples, plotting all the samples can be time consuming.

- 3 Display the generated virtual patients and dose combinations numerically in a tabular format. On the **Home** tab, click **New Datasheet**. From the **LastRun** folder of the program, drag **samples** into the new datasheet. Each row of the table represents a simulation scenario with different model parameter values and dose amounts.

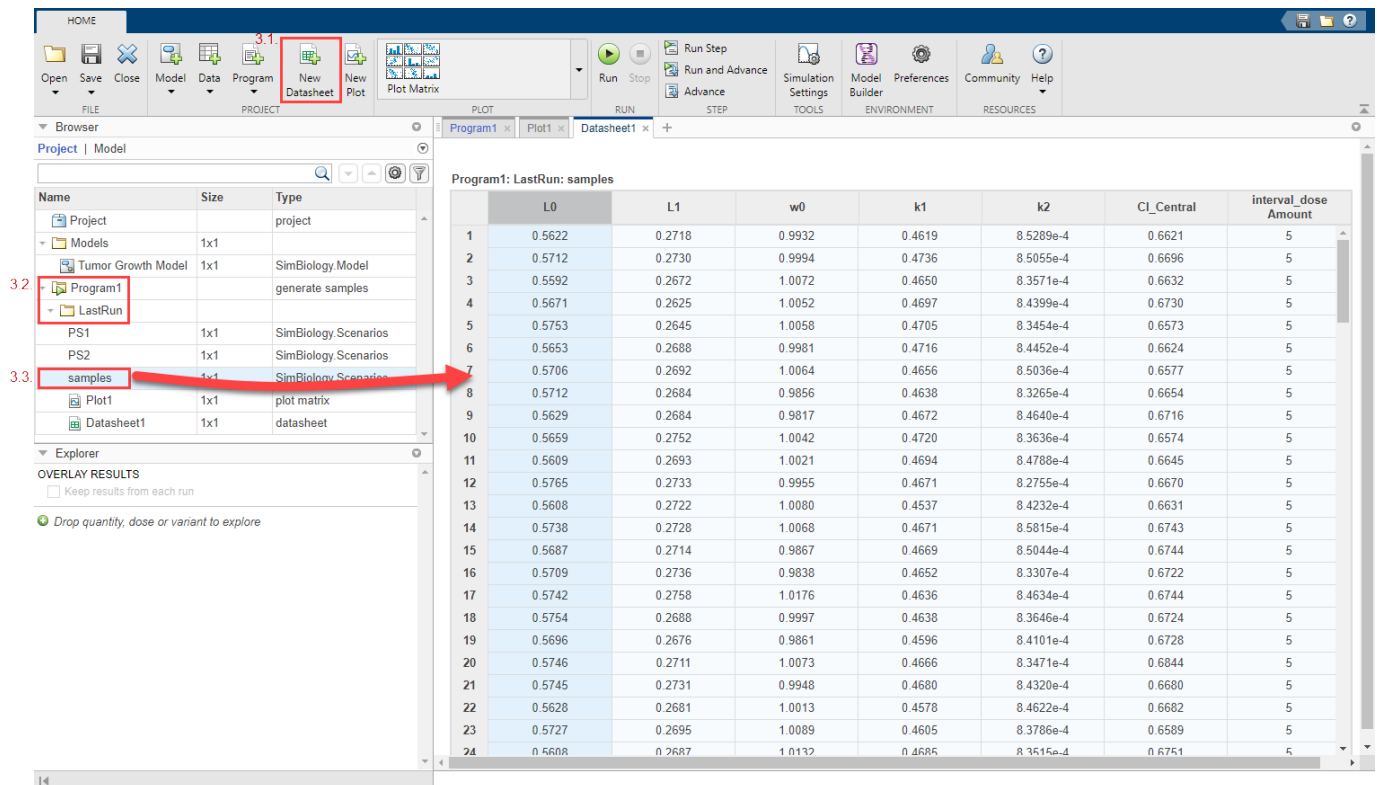

Perform Monte Carlo Simulations

Once you have the samples ready, you can simulate the model to explore the tumor growth of virtual patients receiving different dose amounts.

- 1 Go back to the program by clicking the **Program1** tab.
- 2 Click the (+) icon at the upper left and click **Simulation**.

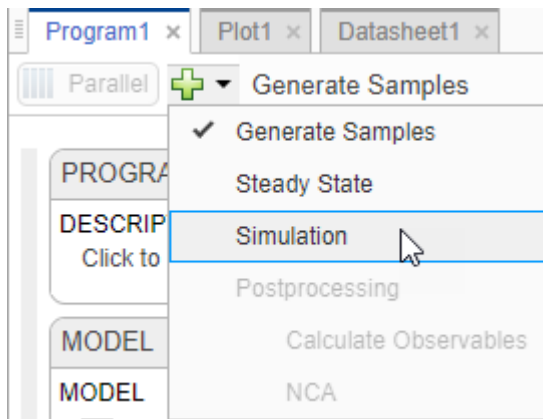

- 3 In the **Model** setup step, in the **Variants** section, make sure that **parameterEstimates** is selected. Also make sure that no doses are selected in the **Doses** section. In the **States To Log** section, click the option for viewing the states, and then clear all check boxes except **[Tumor Growth Model].tumor_weight**.

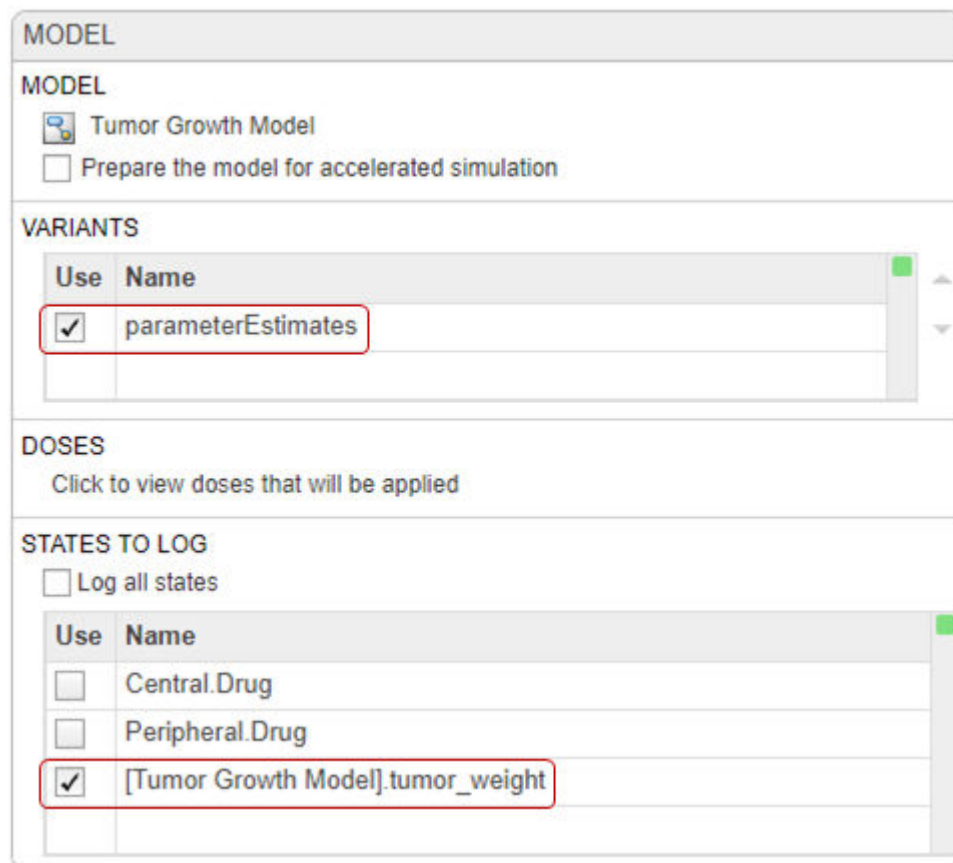

- 4 At the top of the **Simulation** step (scroll down to see this step), click the plot button to disable default plot generation.
- 5 Click the **Run this program step** button to simulate the model.

The app simulates the generated scenarios from the **Generate Samples** step that you ran previously. You do not need to rerun the step.

Once the simulation finishes, the app saves the simulation **results** in the **LastRun** folder.

- 6 In the **LastRun** folder in the **Browser** pane, click **results**. In the **Plot** section on the **Home** tab, click **time**. Each line in the plot represents the tumor weight profile of each simulation scenario.

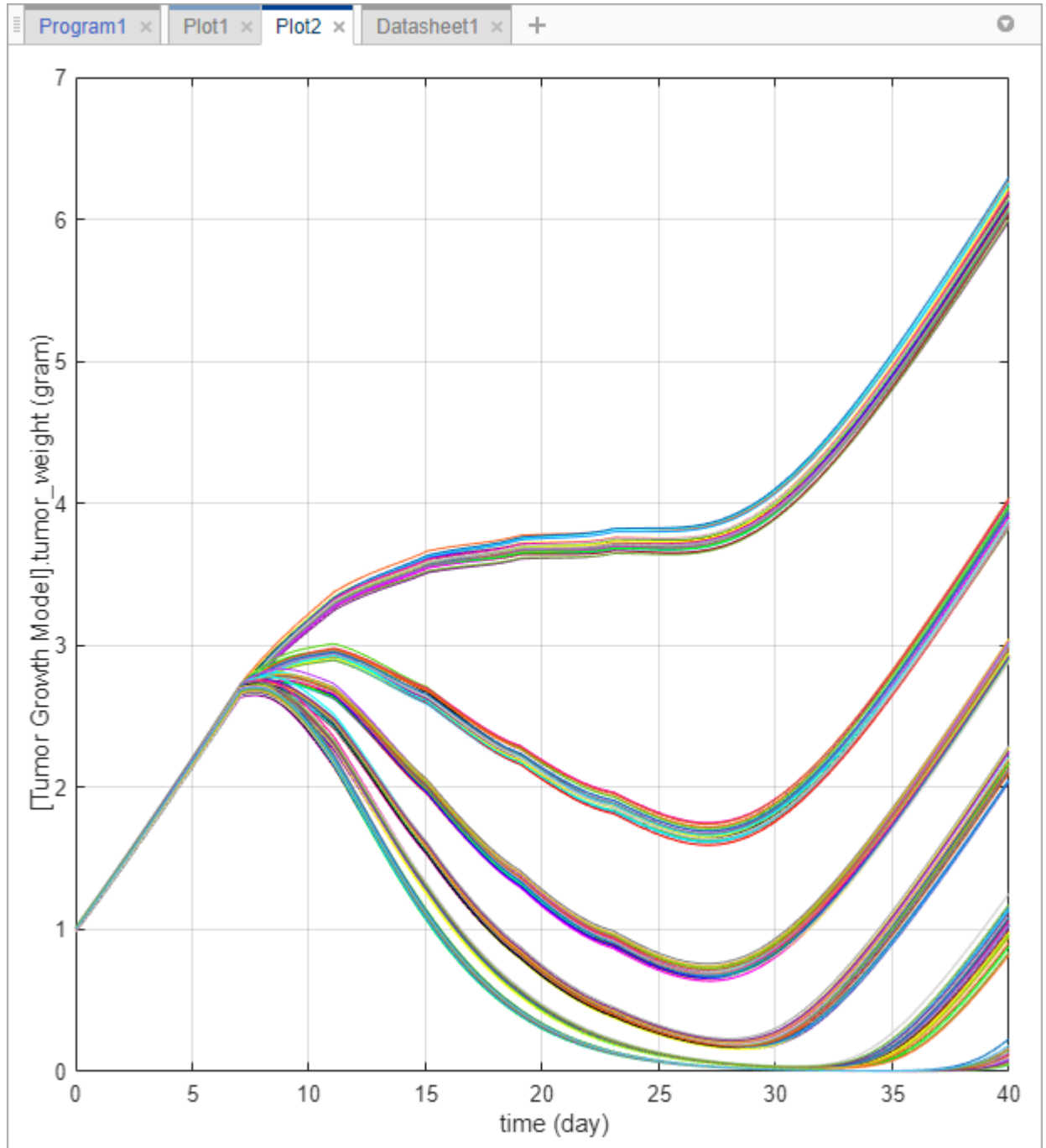

The plot shows that the tumor weight profiles appear in groups, corresponding to different dose amounts. To better visualize this observation, you can slice the data by dose amounts. To do so, you can use the **Slice Data** table, which contains a summary of slicing variables that are currently being used in the plot and their corresponding plot styles.

Tip Plots are backed by data that are currently present in the app workspace. Plots are not snapshots. When the data (either experimental data or simulation results) is removed or changed, the plots are also updated according to the changes in the underlying data.

- 7 On the **Slice Data** tab of **Property Editor**, in the **Visual Channels** table, double-click L0 and select interval_dose Amount.

Slice by	Style
Responses	Line Style
Scenarios	Color
L0	
L0	
L1	
w0	
k1	
k2	
CI_Central	
interval_dose Amount	Width

Tip You can slice data using different slicing variables. Each slicing variable appears in the plot with a different visual *style* (or channel) such as color, line style, and axes position. Slicing variables can represent attributes of data, such as responses or scenarios (that is, groups or simulation runs). Slicing variables can also be covariates or parameter values associated with a scenario or group. By default, the app provides slicing variables for different response variables and different scenarios in the plotted data. You can add other visual styles (or channels) for sets of responses and associated parameter or covariate variables.

- 8 Double-click the empty cell in the **Style** column and select Grid.

Slice by	Style
Responses	Line Style
Scenarios	Color
interval_dose Amount	
L1	Grid
w0	Horizontal
k1	Vertical
k2	Color
	Line Style
	Transparency

The app updates **Plot2** to show each dose amount on its own axes.

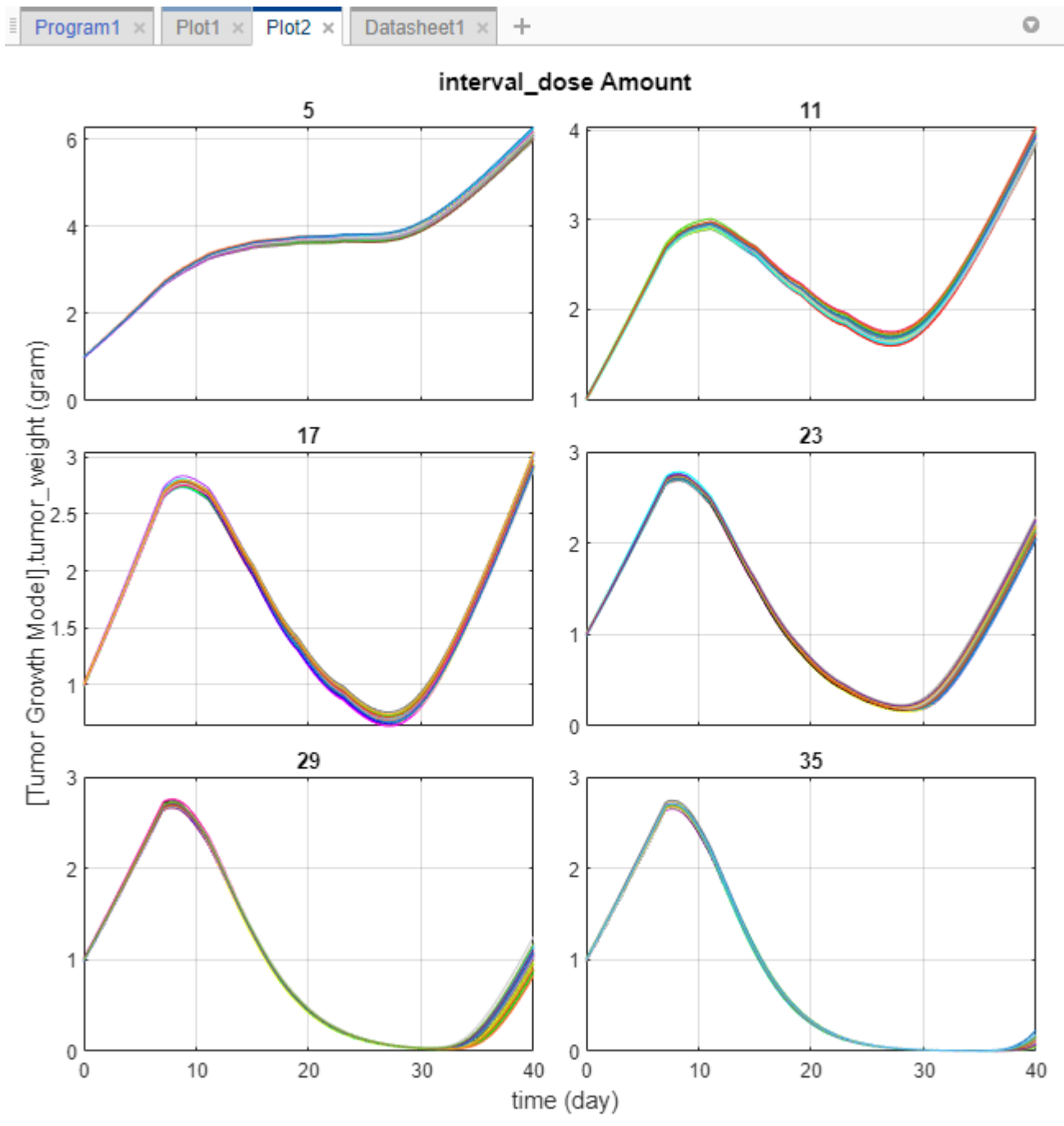

The plot shows that different dose amounts play critical roles in the tumor growth of virtual patients. From this plot, you can obtain some initial insights into the optimal dose amounts and dose scheduling. For instance, suppose that the target tumor weight to reach is 0.5 grams. The simulation results indicate that a dose amount of 23 milligrams or larger can achieve that goal (you can fine-tune the range of dose amounts further by tweaking it in the **Generate Samples** step of the program). You can use this information in combination with existing drug toxicity

information (not discussed in this example) to get a dosing regimen that satisfies both efficacy and safety requirements, for instance.

Postprocess Simulation Data

You can also postprocess the simulation results to look at the correlation between dose amounts and the tumor weight in another way.

- 1 Go back to the program by clicking the **Program1** tab. Click the (+) icon near the top of the program and select **Calculate Observables** under **Postprocessing**.

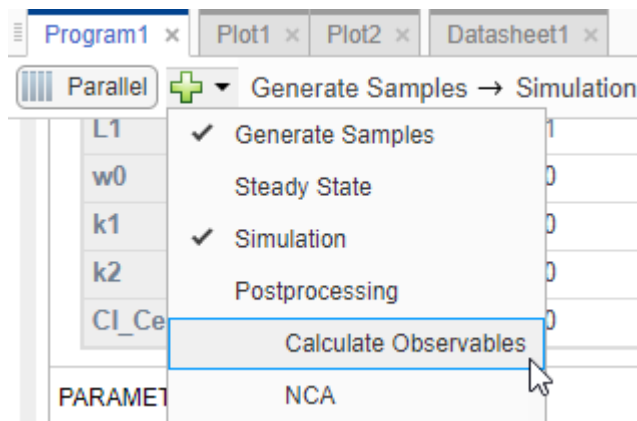

A **Postprocessing: Calculate Observables** step appears below the **Simulation** step.

- 2 Double-click the first cell in the **Name** column. Enter `stat1`.
- 3 In the **Expression** column, enter the following expression:
`min(vertcat(nan,tumor_weight(time>=7)))`. The expression returns the minimum tumor weight after the first dose applied at day 7 from each simulation.

Note Anytime you add an expression to the **Observables** table in the step, the expression is automatically added as an observable object to the corresponding model.

- 4 In the **Units** column, enter `gram`.
- 5 Rerun the simulation step by clicking the run button at the top of the step. The app simulates and evaluates the `stat1` expression for each simulation scenario or iteration, and generates the following plot. The x-axis represents the parameters and the y-axis represents the minimum tumor weight. Each dot represents a simulation scenario. The plot also shows that there is no correlation between the tumor size and the values of various model parameters, except for the dose amounts (the rightmost subplot).

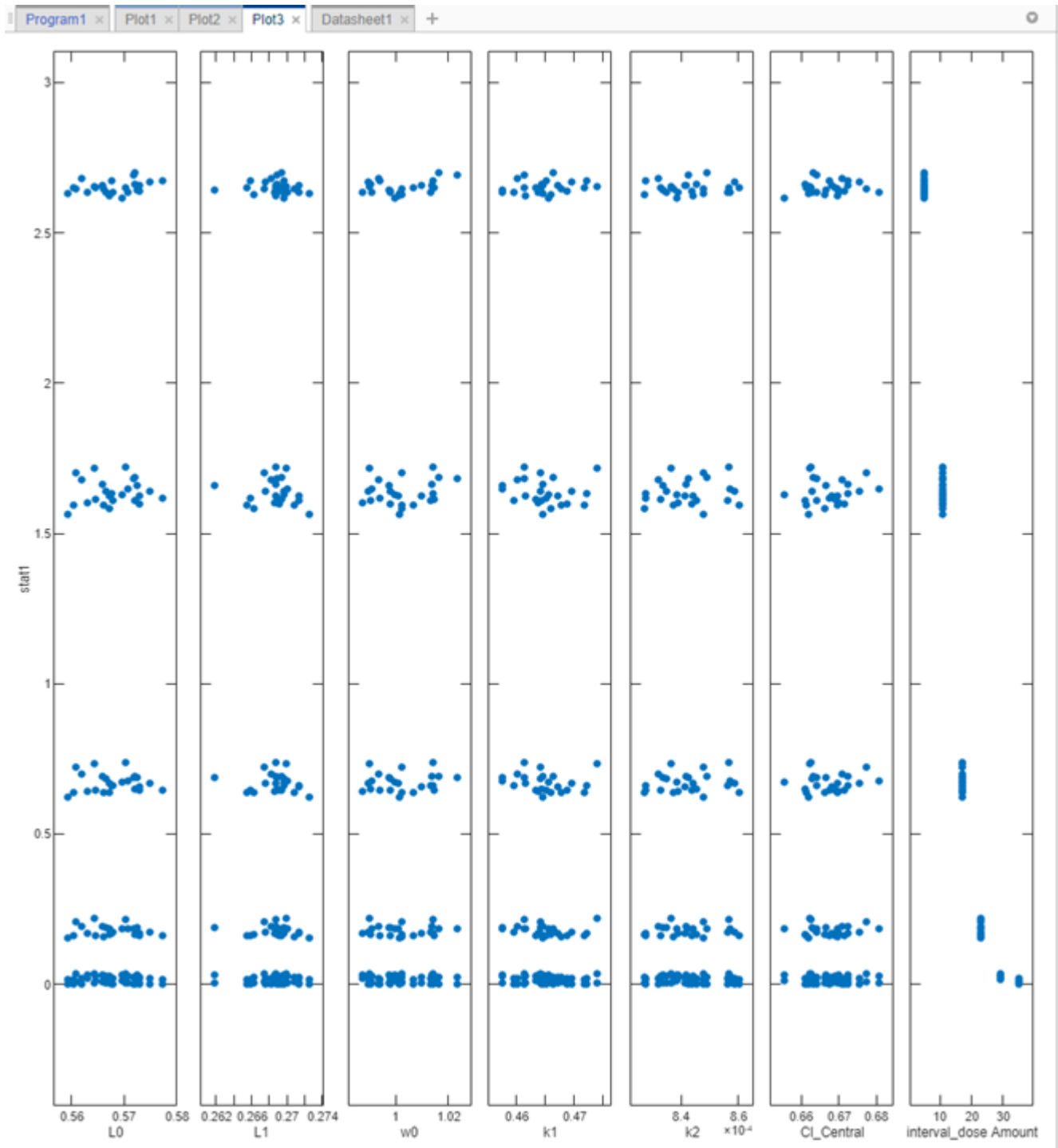

- 6 Show only the dose amount subplot. In the **Plot Settings**, clear all check boxes in the **Parameters** table, except `interval_dose Amount`.

In the **Grid** section, select **both** to show the grids for both the x- and y-axis.

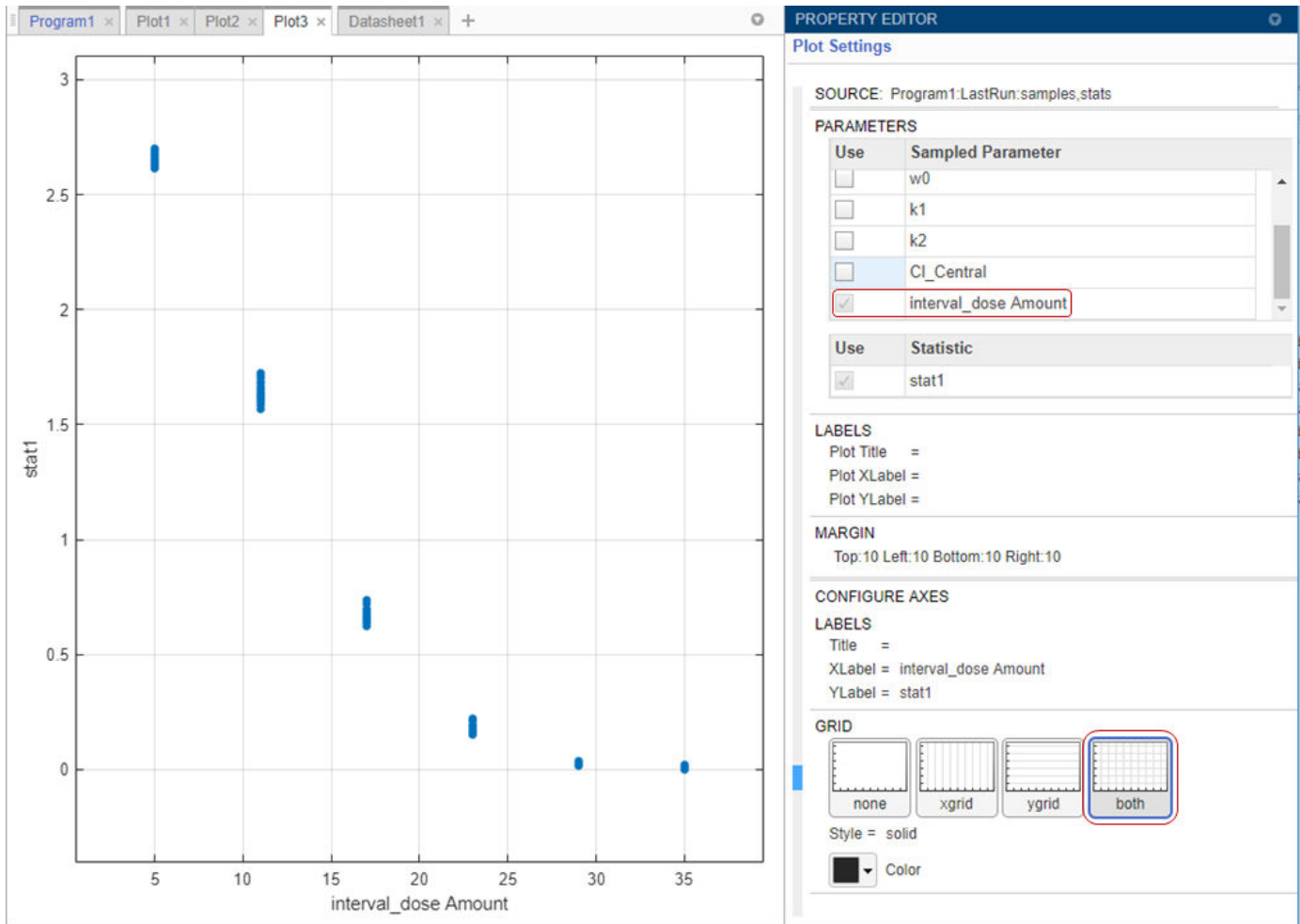

The plot confirms that higher dose amounts control the tumor growth better. These initial simulation results indicate that the dose amounts of 23 mg or larger could reach the hypothetical tumor weight threshold of 0.5 grams or lower. You can further adjust the range of dose amounts in the **Generate Samples** step.

Tip To interactively explore the plotted data, export the plot to a separate figure window by selecting **Export Plot** from the context (right-click) menu of the plot.

This example shows you how to generate samples to represent virtual patients and perform Monte Carlo simulations to explore the model response on tumor growth under different dose amounts. The simulation results indicate a range for dose amounts and dose schedules that controls the tumor growth for various virtual patients. You could further adjust the dosing regimens so that the doses stay within some known efficacy and toxicity thresholds. For a similar analysis, see the example “Scan Dosing Regimens Using SimBiology Model Analyzer App” on page 1-108.

References

- [1] Simeoni, M., P. Magni, C. Cammia, G. De Nicolao, V. Croci, E. Pesenti, M. Germani, I. Poggesi, and M. Rocchetti. 2004. Predictive pharmacokinetic-pharmacodynamic modeling of tumor growth

kinetics in xenograft models after administration of anticancer agents. *Cancer Research*. 64:1094-1101.

See Also

SimBiology Model Analyzer | Observable

More About

- “Calculate NCA Parameters and Fit Model to PK/PD Data Using SimBiology Model Analyzer App” on page 1-77
- “Find Important Parameters with Local Sensitivity Analysis Using SimBiology Model Analyzer App” on page 1-41
- “Scan Dosing Regimens Using SimBiology Model Analyzer App” on page 1-108

Calculate NCA Parameters and Fit Model to PK/PD Data Using SimBiology Model Analyzer App

This example shows how to perform noncompartmental analysis to calculate NCA parameters and estimate the tumor growth model [1] parameters from experimental data using nonlinear regression in the **SimBiology Model Analyzer** app.

Tumor Growth Model

The model used in this example is a SimBiology implementation of the pharmacokinetic/pharmacodynamic (PK/PD) model by Simeoni et al. It quantifies the effect of anticancer drugs on tumor growth kinetics from *in vivo* animal studies. The drug pharmacokinetics are described by a two-compartment model with IV bolus dosing and linear elimination (ke) from the *Central* compartment. Tumor growth is a biphasic process with an initial exponential growth followed by linear growth. The growth rate of the proliferating tumor cells is described by

$$\frac{L_0 * x_1}{\left[1 + \left(\frac{L_0}{L_1} * w\right)^\Psi\right]^{1/\Psi}}$$

L_0 , L_1 , and Ψ are tumor growth parameters, x_1 is the weight of the proliferating tumor cells, and w is the total tumor weight. In the absence of any drugs, the tumor consists of proliferating cells only, that is, $w = x_1$. In the presence of an anticancer agent, a fraction of the proliferating cells is transformed into nonproliferating cells. The rate of this transformation is assumed to be a function of the drug concentration in the plasma and an efficacy factor k_2 . The nonproliferating cells x_2 go through a series of transit stages (x_3 and x_4) and are eventually cleared from the system. The flow-through of the transit compartments is modeled as a first-order process with the rate constant k_1 .

The SimBiology model makes these adjustments to the pharmacodynamics of tumor growth:

- Instead of defining the tumor weight as the sum of x_1 , x_2 , x_3 , and x_4 , the model defines the tumor weight by the reaction named *Increase*, $\text{null} \rightarrow \text{tumor_weight}$, with the reaction rate $\left(2 * L_1 * L_0 * x_1^2 / L_1 + 2 * L_0 * x_1\right) * \text{tumor_weight}$.

tumor_weight is the total tumor weight, x_1 is the weight of the proliferating tumor cells, and L_0 , and L_1 are tumor growth parameters.

- Similarly, the model defines the decrease in tumor weight by the reaction named *Decay*, $\text{tumor_weight} \rightarrow \text{null}$, with the reaction rate $k_1 * x_4$. The constant k_1 is the forward rate parameter, and x_4 is the last species in the series of transit reductions in tumor weight.
- ke is a function of the clearance and the volume of the central compartment: $ke = Cl_Central / Central$.

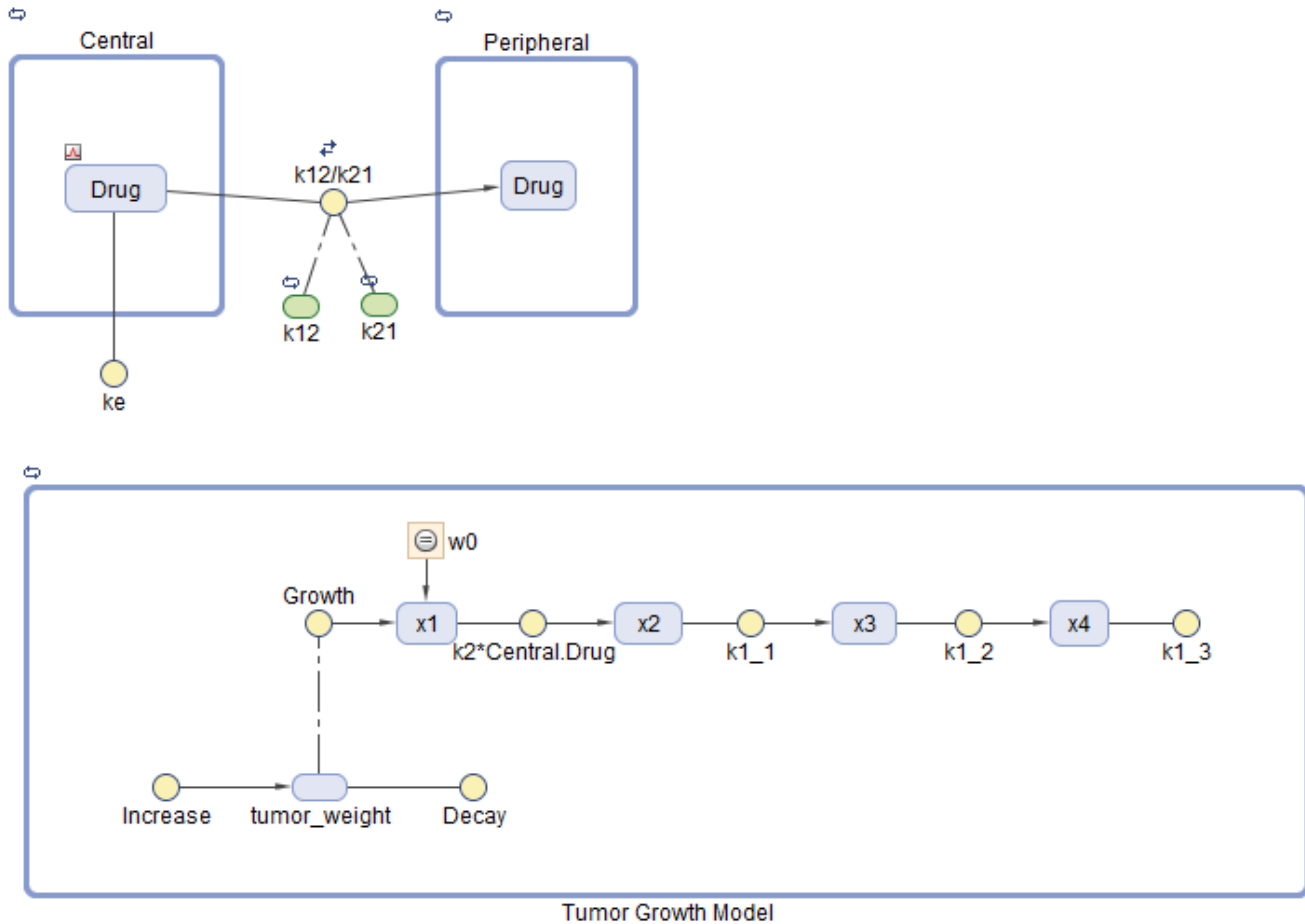

PK/PD Data Description

The experimental (synthetic) data contains measurements from eight patients for three responses: measured drug concentrations in the central compartment, in the peripheral compartment, and measured tumor weight. The data also contains the dosing information, and each patient receives an IV dose at day 7.

The data set contains the following columns.

- *ID* — Patient IDs
- *Time* — Times when measurements are taken
- *CentralConc* — Drug concentration in the central compartment
- *PeripheralConc* — Drug concentration in the peripheral compartment
- *Dose* — Dosing information for each patient

NaN values are used whenever there is no measurement or no dose is given.

Load Tumor Growth Model and Data

- 1 At the command line, enter:

```
simBiologyModelAnalyzer("tumor_growth_fitPKPD.sbproj");
```

- 2 **SimBiology Model Analyzer** opens. In the **Browser** pane, the **Models** folder contains the Tumor Growth Model and the **Data1** folder contains the experimental data along with the dosing information.
- 3 Classify the data columns so that such variable classifications can be used by the **Fit** program later in the example. The app performs automatic classifications as appropriate (such as the *ID*, *Time*, *Dose* columns). But for the measured response data columns such as *CentralConc*, you need to manually classify them as the dependent variables. To do so, first open the data sheet as follows. In the **Browser** pane, expand the **Data1** folder and double-click **Datasheet1**.
- 4 In the **Data1** table, double-click **Classification** under *CentralConc*. Select **dependent**. Repeat the same process for *PeripheralConc* and *TumorWeight*. You can leave the *k1* and *Cl_Central* columns unset.

Note The app has automatically classified:

- The *ID* column as **group** (a grouping variable).
- The *Time* column as **independent** (an independent variable).
- The *Dose* column as **dose1** (a dosing variable). If there are more than one dose columns, they can be classified as **dose2**, **dose3**, and so on.

	ID	Time	CentralConc	PeripheralConc	TumorWeight	Dose	k1	Cl_Central
	group	independent	CLASSIFICATION	CLASSIFICATION	CLASSIFICATION	dose1	CLASSIFICATION	CLASSIFICATION
		day	milligram/liter	milligram/liter	gram	milligram	1/day	liter/hour
1	1	0	NaN	NaN	0.9810	NaN	0.4780	0.7370
2	1	1	NaN	NaN	1.0120	NaN	NaN	NaN
3	1	3	NaN	NaN	1.5840	NaN	NaN	NaN
4	1	5	NaN	NaN	1.7820	NaN	NaN	NaN
5	1	6	NaN	NaN	3.2260	NaN	NaN	NaN
6	1	7	13.5510	NaN	3.1500	30	NaN	NaN
7	1	7.2500	1.9650	0.6970	3.0860	NaN	NaN	NaN
8	1	7.5000	0.2840	0.7680	2.8690	NaN	NaN	NaN
9	1	7.7500	0.0680	0.4010	2.9910	NaN	NaN	NaN
10	1	8	0.0370	0.2980	2.2770	NaN	NaN	NaN
11	1	9	0.0070	0.0690	2.5190	NaN	NaN	NaN
12	1	10	0.0020	0.0170	2.5060	NaN	NaN	NaN

Visualize Experimental Data

After you load the data, you can visualize the measured responses.

- 1 In the **Browser** pane, click **Data1**.
- 2 On the **Home** tab, in the **Plot** section, click the **time** plot. The app generates a time plot of all three responses, namely: *CentralConc*, *PeripheralConc*, and *TumorWeight*.

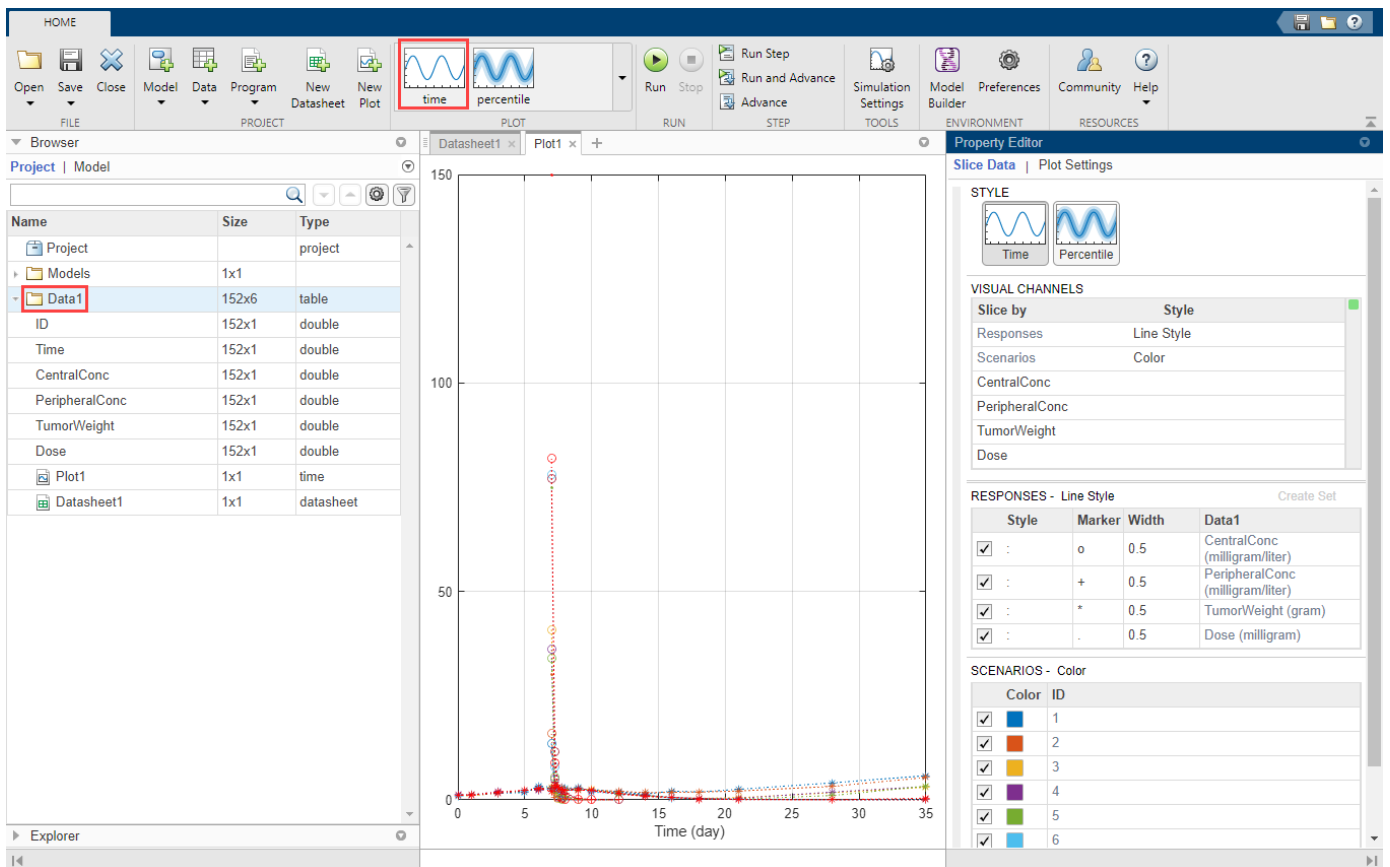

In the default time plot, **Responses** correspond to the measured responses and are plotted using different line styles. **Scenarios** refers to different groups (eight patients) in the data and are plotted using different colors.

Tip Plots are backed by data that are currently present in the app workspace. Plots are not snapshots. When the data (either experimental data or simulation results) is removed or changed, the plots are also updated according to the changes in the underlying data.

Customize Data Visualization

The steps in this section are optional and are not necessary for fitting. You can customize the plot to make it clearer. For example, you can plot the PD data (*TumorWeight*) on a different axis than the PK data (*CentralConc* and *PeripheralConc*). To do so, create two different groups (*sets*) of responses, where the first set contains only *TumorWeight* and the second set contains *CentralConc* and *PeripheralConc*.

- Right-click **TumorWeight (gram)** in the **Responses** table and select **Create New Set**. The app creates **Set 1** and **Set 2**. **Set 1** contains only *TumorWeight*, which is now plotted on a different axis than **Set 2**, which contains *CentralConc* and *PeripheralConc*.

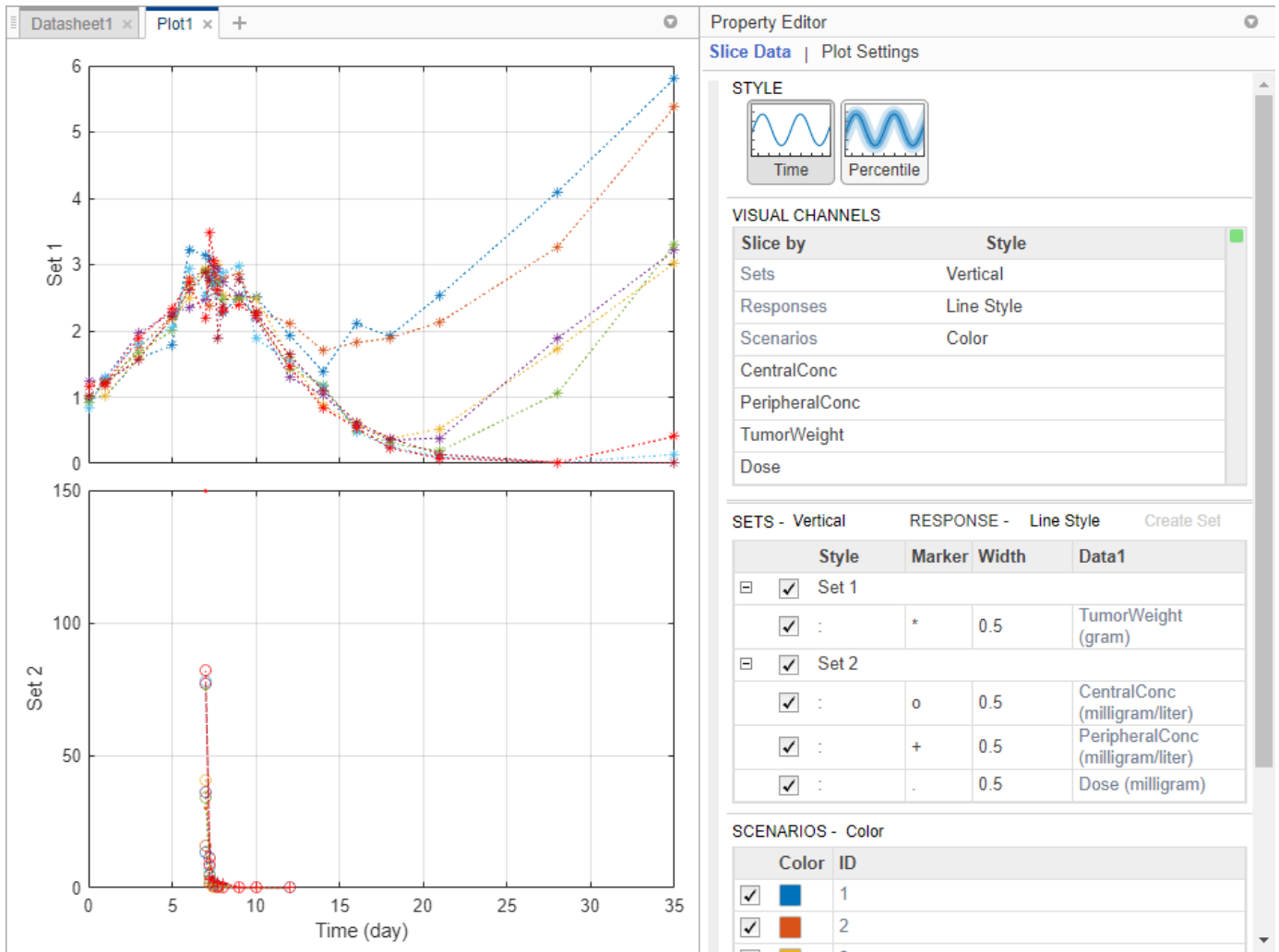

The **Visual Channels** table now contains **Sets**. This table is a summary table of all slicing variables that are currently present in the plot and their corresponding plot styles. In this current plot, the slicing variables are **Sets**, **Responses**, and **Scenarios**.

Tip You can slice data using different slicing variables. Each slicing variable appears in the plot with a different visual *style* (or channel) such as color, line style, and axes position. Slicing variables can represent attributes of data, such as responses or scenarios (that is, groups or simulation runs). Slicing variables can also be covariates or parameter values associated with a scenario or group. By default, the app provides slicing variables for different response variables and different scenarios in the plotted data. You can add other visual styles (or channels) for sets of responses and associated parameter or covariate variables.

You can also group the responses based on different dose amounts that the patients receive. There are three different dose groups: 30, 75, and 150 mg.

- 1 In the **Visual Channels** table, at the **Dose** row, double-click the empty cell and select **Color**. A red indicator appears because another slicing variable (**Scenarios**) has the same plot style. Clear the style (visual channel) for **Scenarios** by selecting empty.

- In the **Dose** table, the app has automatically binned the dose amounts. Set **Number of Bins** to 3. You can now see that the dose amount has an impact on the tumor size. The higher the dose is, the smaller the tumor becomes.
- You can also query the corresponding dose group from each line by showing its data tip. Press **Ctrl** and click a blue line to display its data tip. To remove it, **Ctrl + Click** again anywhere on the same line.

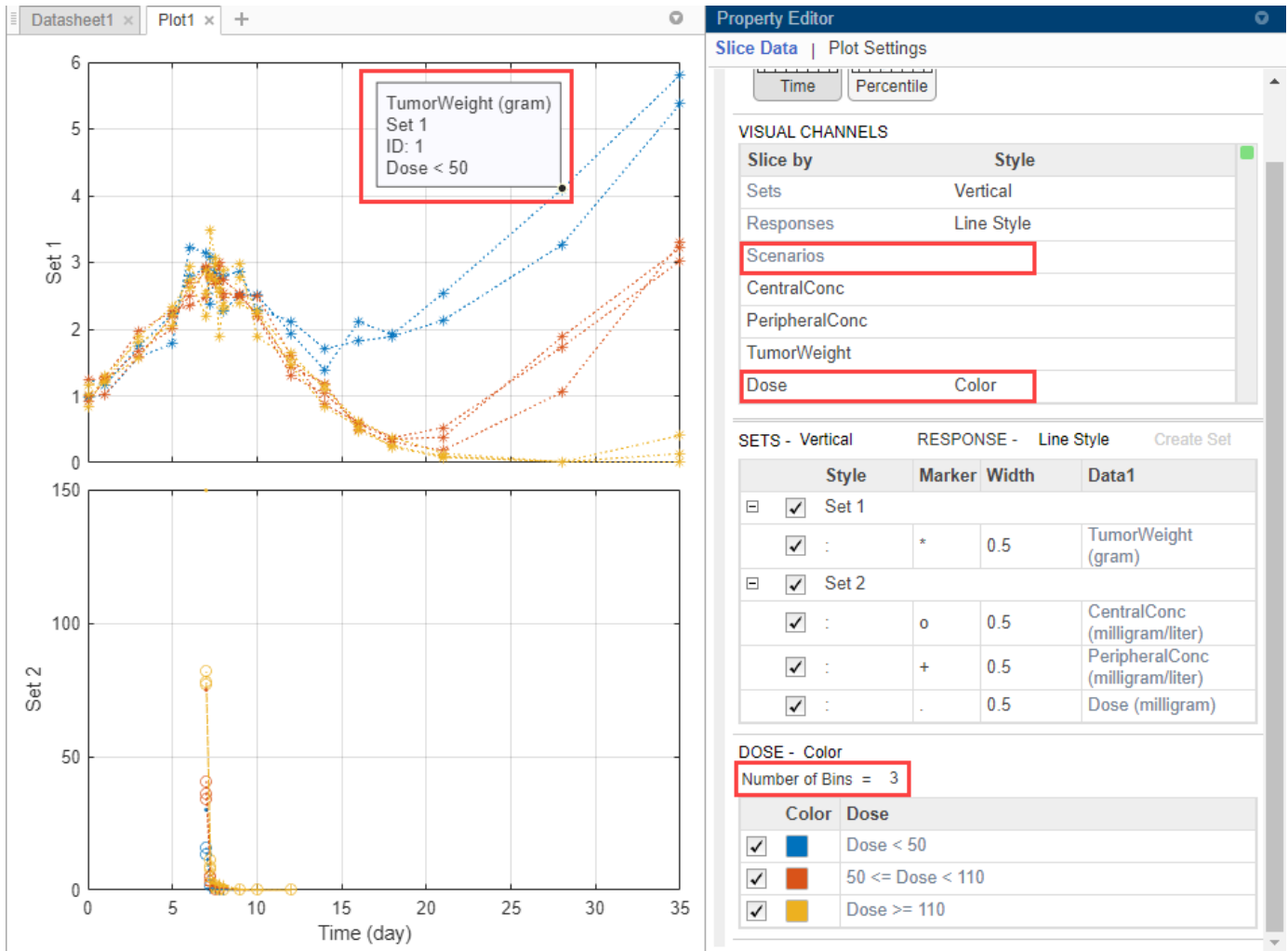

Perform Noncompartmental Analysis (NCA)

Using the drug pharmacokinetic data, you can estimate NCA parameters. NCA is model agnostic and can give insights into the drug pharmacokinetics without any underlying assumptions. You can use some of the NCA results as initial estimates when calibrating the model to the data, as discussed later in this example. For details on the list of available NCA parameters and their formulas, see “Noncompartmental Analysis” on page 4-88.

NCA Program Setup

- On the **Home** tab, select **Program > Non-Compartmental Analysis**. A new program (**Program1**) appears.

- The **Data setup** step of the program defines the data set to use for the NCA analysis. In this example, the program automatically selects **Data1**.

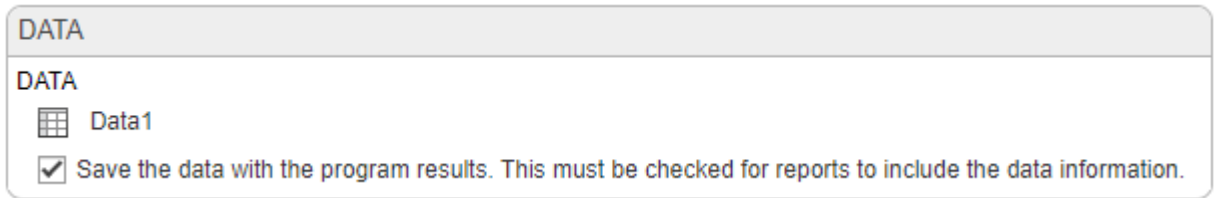

- The **NCA execution** step defines the data column associations and algorithm details. In the **Definition** table, set **Concentration** to **CentralConc**. Leave the other settings unchanged.

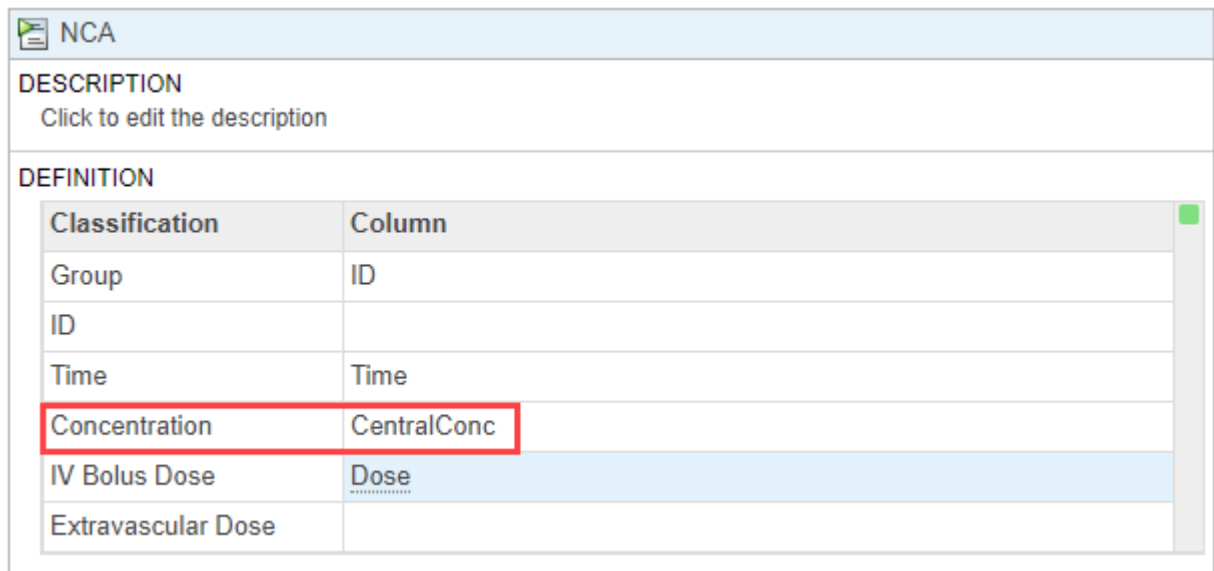

- On the **Home** tab, click **Run**.

Once the NCA analysis is complete, the app opens a new datasheet containing the results.

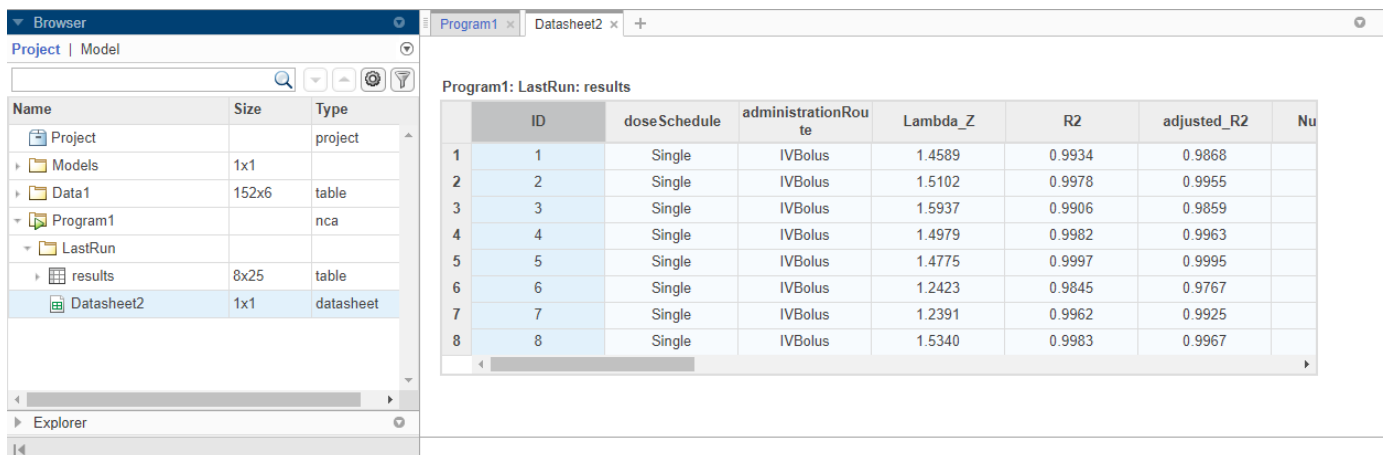

The program also saves the results in the **LastRun** folder of the program by default. To access the results, in the **Browser** pane, expand the **Program1** folder. Then expand **LastRun** folder. The NCA

results are stored in the table named **results**. For details about calculated NCA parameters, see “Noncompartmental Analysis” on page 4-88.

Export Results to MATLAB Workspace

You can export the NCA results to the MATLAB workspace and perform further data analyses at the command line.

- 1 Right-click **results**. Select **Export Data to MATLAB Workspace**.

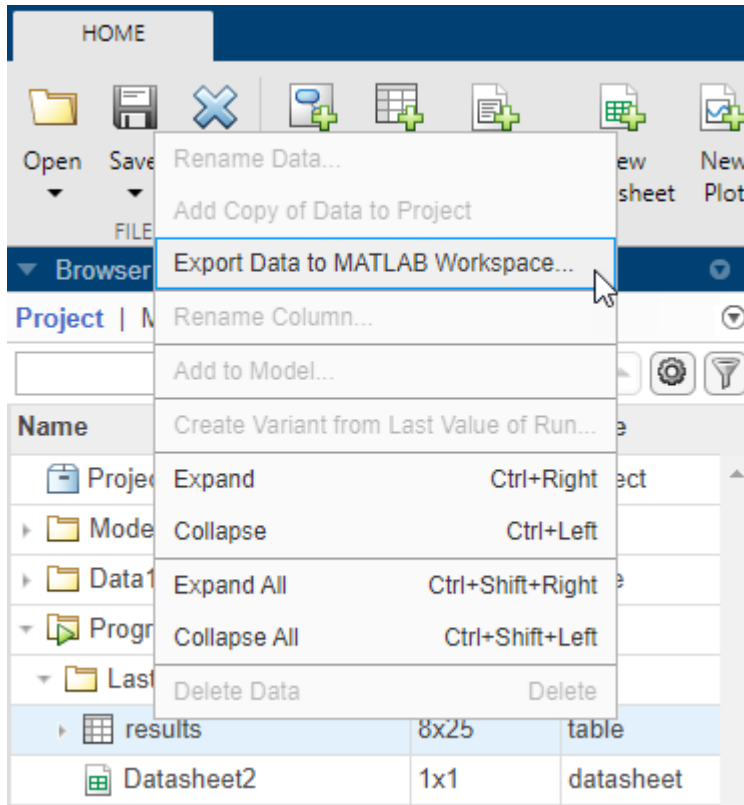

- 2 The **SimBiology Data Export** dialog box opens. Change the name of the variable to **ncatable**. Click **OK**.

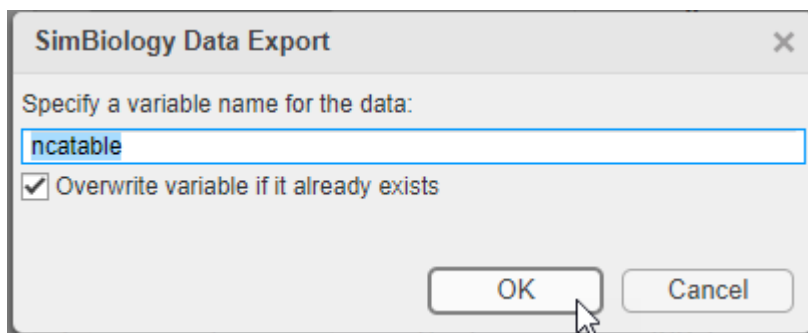

After you export the data to the MATLAB workspace, you can analyze the data at the command-line. For instance, you can calculate the average drug clearance from the NCA data and use it as the model parameter value.

Estimate Model Parameters Using Nonlinear Regression

SimBiology provides different regression techniques to estimate model parameters based on experimental data. This example details the steps for using the nonlinear regression method `lsqnonlin` (requires Optimization Toolbox™) to fit the model to the data. If you do not have Optimization Toolbox, the app uses `fminsearch` instead. For the purposes of the example, only some of the PK/PD model parameters are estimated, namely: k_1 , L_0 , L_1 , $Cl_Central$, k_{12} , and k_{21} .

Fit Program Setup

- 1 From the **Home** tab, select **Program > Fit Data**. A new program (**Program2**) appears on a new tab. The **Data** and **Model** steps have been prepopulated with **Data1** and **Tumor Growth Model**, respectively.
- 2 By default, the **Fit** step autogenerates plots after the fitting is complete. Disable the plot generation by clicking the plot icon at the top of the **Fit** program step for now. The plots will be explored later in the example.

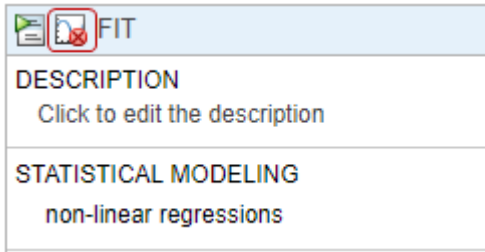

- 3 In the **Data Map** table, define the mapping between the model components and the data columns from the input data.
 - The **group** row identifies which column in the data is a grouping variable, such as patient IDs.
 - The **independent** row identifies which column in the data is an independent variable, such as time.
 - The **response** row identifies which response or measurement data column corresponds to which model component. If there are multiple response data, you can add more response rows by clicking the **Response** button at the bottom of the **Data Map** table. To delete a response from the table, right-click and select **Delete**.
 - The **dose from data** row defines which column in the data maps to which model component as a dose target. If there are multiple dose columns, you can add more rows by clicking the **Dose** button.
 - The **variant from data** row defines which column in the data contains alternative parameter values for which model component. Click the **Variant** button to see the row or add more variants.



Note In this example, the app uses the classification information from the data sheet of the input data and maps the *ID* column as the grouping variable (defined by the **group** row in the table), and *Time* column as an independent variable (defined by the **independent** row in the table). It has also identified *CentralConc*, *PeripheralConc*, and *TumorWeight* as response columns.

- a In the first response row, next to *CentralConc*, double-click the cell **Component**, and enter *Central.Drug* as the corresponding model component for that measurement data column.

- b Similarly, map the *PeripheralConc* column to *Peripheral.Drug*.
- c Map *TumorWeight* to *[Tumor Growth Model].tumor_weight*.
- d Map the *Dose* column to *Central.Drug* to indicate that the *Drug* species in the *Central* compartment is being dosed.

DATA MAP

Use	Classification	Value	
	group	ID	
	independent	Time	
<input checked="" type="checkbox"/>	⊕ response	CentralConc	~ Central.Drug
<input checked="" type="checkbox"/>	⊕ response	PeripheralConc	~ Peripheral.Drug
<input checked="" type="checkbox"/>	⊕ response	TumorWeight	~ [Tumor Growth Model].tumor_weight
<input checked="" type="checkbox"/>	⊕ dose from data	Dose	-> Central.Drug Bolus Dose

Add to Map:  Response  Dose  Variant

- 4 Leave the **Variant and Dose Setup** table as is because there is no group-specific doses or variants being used in this example. For details on how to use this table, see “Simulate Groups Using Doses and Variants from Data Set” on page 1-135.
- 5 In the **Fit** step, define the model parameters to estimate in the **Estimated Parameters** table. Double-click the empty cell in the **Estimated Parameters** column and type *k1*. The app shows model components with matching names. Select *k1* from the list.

ESTIMATED PARAMETERS

Use	Estimated Parameters
<input type="checkbox"/>	k1
<input type="checkbox"/>	Pool
<input type="checkbox"/>	ERROR

By default, the parameter is log-transformed as indicated by the transformation **log**. You can change the transformation to no transformation **none**, **probit**, or **logit** transformation. For details, see “Parameter Transformations” on page 4-37. For this example, keep the default log transform because it often improves the convergence. The **Initial Untransformed Value** is automatically set to the model value which is 0.5.

- 6 Enforce the biological parameters to stay positive by specifying the **Untransformed Lower Bound** and **Untransformed Upper Bound** as $1e-5$ and 10 , respectively.
- 7 Similarly, add the following parameters: *Cl_Central*, *L0*, *L1*, *k12*, and *k21*.

ESTIMATED PARAMETERS

Use	Estimated Parameters	Transformation	Category Variable
<input checked="" type="checkbox"/>	<input type="checkbox"/> k1 Initial Untransformed Value = 0.5000 Untransformed Lower Bound = 1.0000e-5 Untransformed Upper Bound = 10	= log	
<input checked="" type="checkbox"/>	<input type="checkbox"/> Cl_Central Initial Untransformed Value = 0.7000 Untransformed Lower Bound = 1.0000e-5 Untransformed Upper Bound = 10	= log	
<input checked="" type="checkbox"/>	<input type="checkbox"/> L0 Initial Untransformed Value = 0.4000 Untransformed Lower Bound = 1.0000e-5 Untransformed Upper Bound = 10	= log	

- 8 Select **Pooled fit** to estimate one set of parameters for all patients (population fit). If you do not select **Pooled fit**, the app estimates one set of parameters for each patient (individual fit).

Untransformed Lower Bound	= 1.0000e-5
Untransformed Upper Bound	= 10
<input checked="" type="checkbox"/> Pooled fit	
ERROR MODEL	
Use the same error model for each response	: constant

- 9 The default error model is the constant error model. SimBiology supports constant, proportional, exponential, and combined error models. For details, see “Error Models” on page 4-44. For now, use the constant error model.
- 10 Keep the rest of the fitting settings unchanged. These settings are
- Estimation Method — The default method is `lsqnonlin` if you have Optimization Toolbox. If you do not, the app uses `fminsearch`.

ESTIMATION METHOD		
<input type="checkbox"/> Use a global solver		
<input checked="" type="radio"/> lsqnonlin	<input type="radio"/> fminunc	<input type="radio"/> lsqcurvefit
<input type="radio"/> fminsearch	<input type="radio"/> fmincon	

For more information, see “Supported Methods for Parameter Estimation in SimBiology” on page 4-42.

- **Algorithm Settings** — Most common options for the estimation method. Click to expand the section and see the options. To see the description of each option, click the info icon to the right of the header.

ALGORITHM SETTINGS 		
ProgressPlot	= true	Show the Fit Data program progress
StepTolerance	= 1.0000e-8	Termination tolerance on the estimated parameters
FunctionTolerance	= 1.0000e-8	Termination tolerance on the objective function value
OptimalityTolerance	= 1.0000e-6	Termination tolerance on the first-order optimality
MaxIterations	= 400	Maximum number of iterations

- **Advanced Algorithm Settings** — Advanced settings for the estimation method. The table is empty by default.

Run Fit Program

After you set the fitting options, you can run the **Fit** step.

- 1 At the top of the **Fit** step, click the **Run this program step** button.

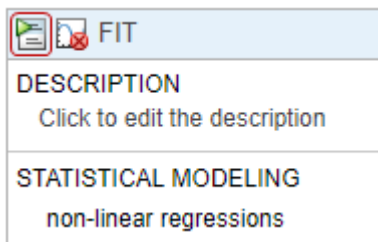

By default, the **Fit** step shows the progress of parameter estimation in a separate figure. The progress plot shows the live status of parameter estimation and fitting quality measures such as log likelihood. For details, see “Progress Plot” on page 4-45.

- 2 The progress plot shows that the fit converged. You can close the progress plot.

If you are using `fminsearch`, the fit can fail to converge due to reaching the maximum number of iterations. You can increase **MaxIter** in the **Algorithm Settings**, but for the purposes of this example, you can continue completing the steps without doing so.

Visualize Fit Results

Once the parameter estimation is complete, the fit results are shown in a new data sheet. The datasheet contains parameter estimates and other information related to fit quality measures, such as AIC and BIC, which can be useful to compare the performance of different error models.

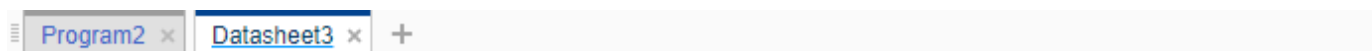

Pooled Parameter Estimates (Program2: LastRun)

	Name	Estimate	StandardError
1	k1	0.4635	0.0160
2	CI_Central	0.6747	0.0111
3	L0	0.5453	0.0014
4	L1	0.2697	0.0140
5	k12	0.0116	0.0013
6	k21	0.0645	0.0111

Statistics (Program2: LastRun)

	Name	Value
1	AIC	534.7027
2	BIC	556.2037
3	LogLikelihood	-261.3513
4	DFE	260
5	MSE	0.4274
6	SSE	111.1263

In addition to quality statistics, you can also view various fit plots, such as actual versus predicted plots and residual distribution plots.

- 1 In the **Browser** pane, expand **Program2 > LastRun**, which contains **results** and **simdataI**. **results** contains estimated parameter values and fit statistics. **simdataI** contains the simulated model responses for each individual (patient or group) using the estimated parameter values.
- 2 Click **results**. Available fit plots are automatically listed in the **Plot** section on the **Home** tab. Then select **Act vs Pred** from the list.

The screenshot displays the SimBiology software interface. The top ribbon is divided into four main sections: HOME, FILE, PROJECT, and PLOT. The PLOT section is currently active, showing two plot thumbnails: 'Fit' and 'Act vs Pred'. The 'Act vs Pred' plot is highlighted with a red box. Below the ribbon is a 'Browser' pane showing a tree view of the project structure. The 'results' folder under 'Program2' is highlighted with a red box. To the right is a 'PROGRAM DE' pane with sections for 'DESCRIPTION', 'MODEL', and 'BASELINE VAR'.

Name	Size	Type
Project		project
Models	1x1	
Data1	152x8	table
Program1		nca
LastRun		
Program2		fit
LastRun		
results	1x1	SimBiology.fit.OptimResults
simdata1	8x1	SimData
time	nx1	double

The actual versus predicted plot appears on a separate tab. The predicted responses are plotted on the x-axis and the observed (experimental) responses are plotted on the y-axis.

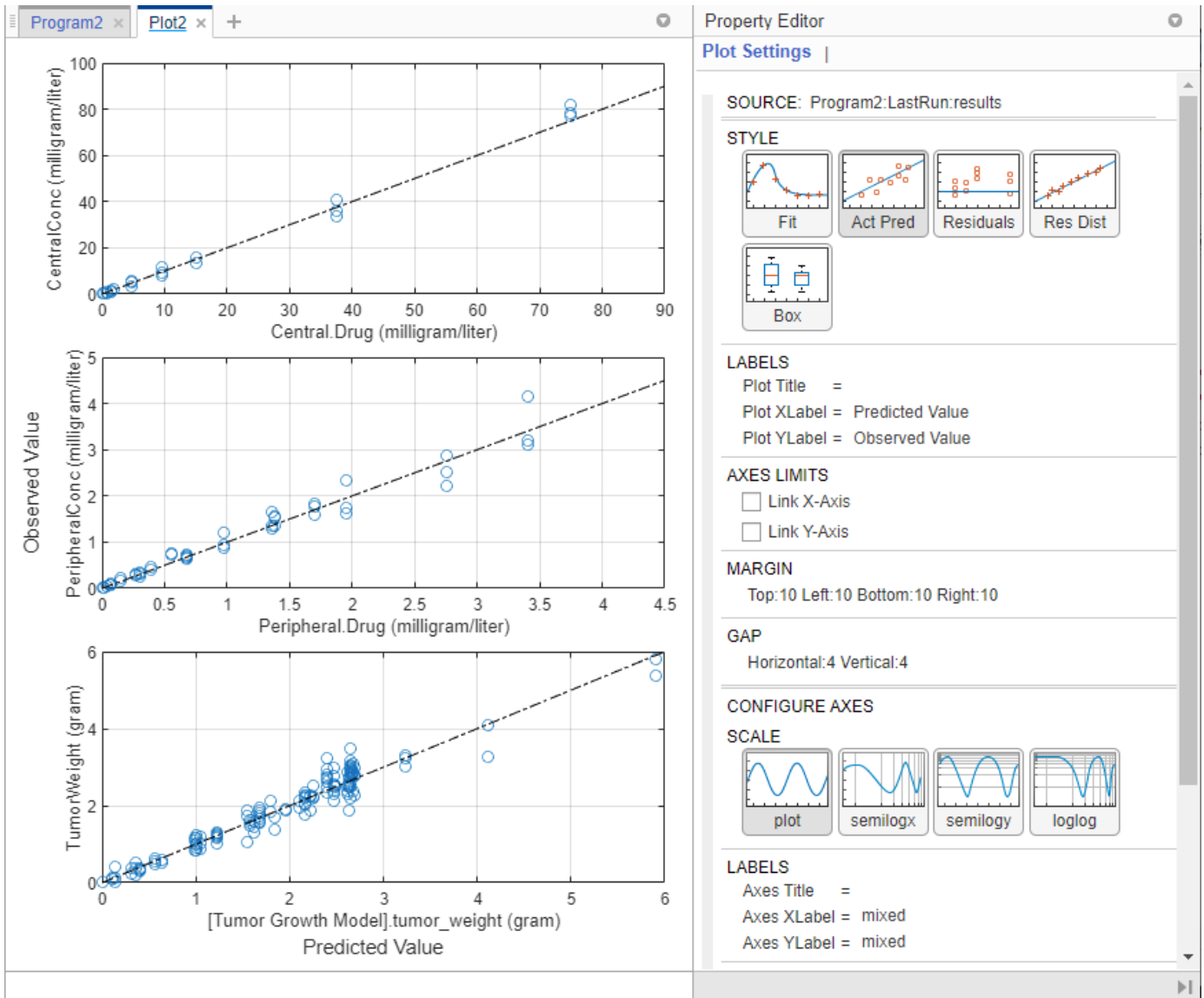

You can change the plot to other supported plots by selecting one of the plots from the **Style** section in the **Property Editor**. If you want the new plot on its own separate tab and you do not want to reuse the existing plot tab, select the plot from the **Plot** section on the **Home** tab.

- 3 Change the plot to a residual distribution plot by selecting **Res Dist** in the **Style** section.

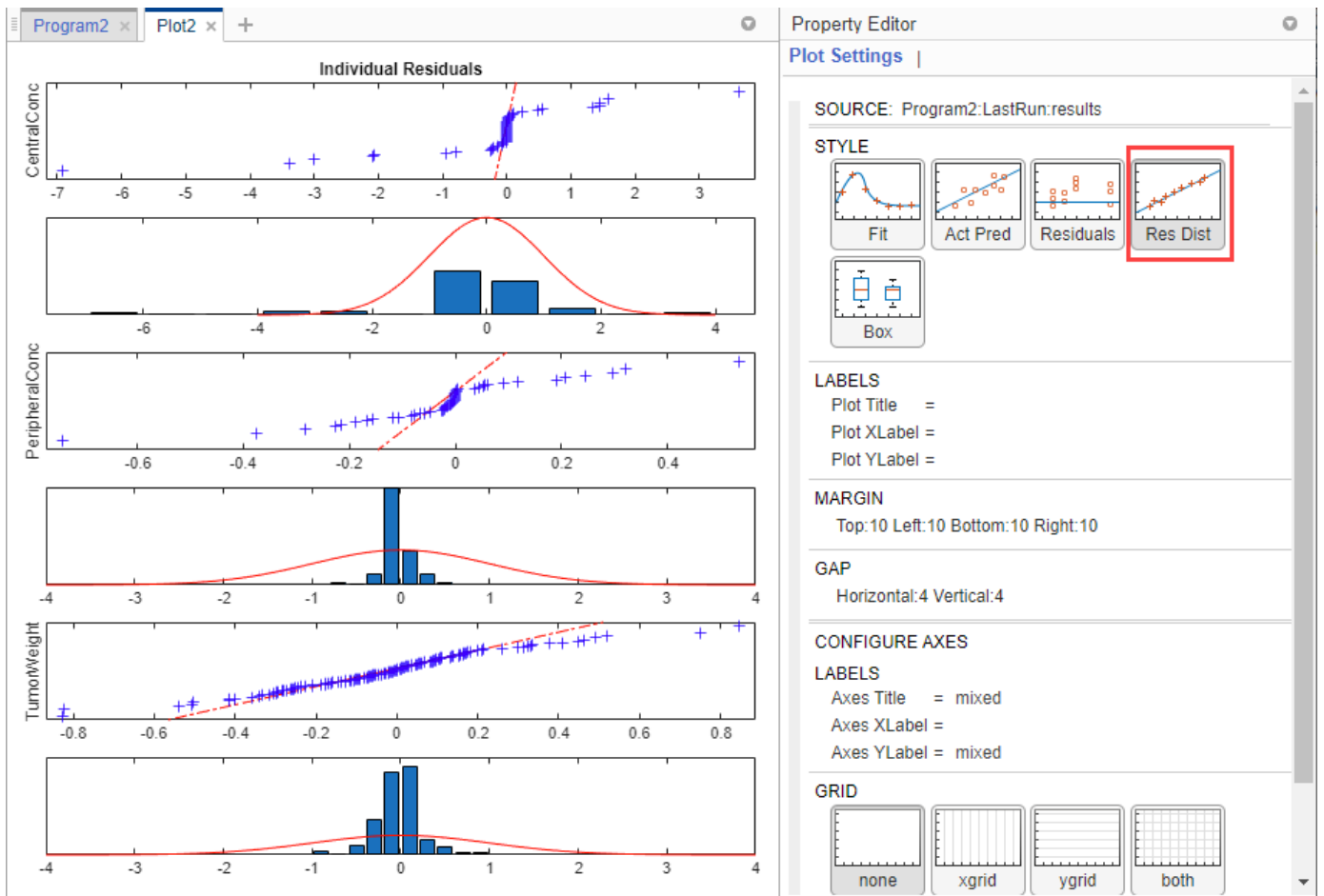

The plot shows whether the residuals for each response are normally distributed. In an ideal normal probability plot of residuals, the residuals line up along the diagonal line across the plot and the histograms indicate a normal fit. However, from the plot, the residuals for all three responses, especially *CentralConc* and *PeripheralConc*, do not seem to be normally distributed. It could be an indication that the constant error model assumption is incorrect.

Compare Different Error Models

The following steps show how to change the error model to an exponential error model to fit the data again and compare the fit statistics of two different error models.

Save Fit Results

Before fitting the data again using the exponential error model, save the constant error model result in a separate folder. Otherwise, the program, by default, overwrites results from the **LastRun** folder every time you run the fit.

- 1 Right-click the **LastRun** folder of the fit program in the **Browser** pane.
- 2 Select **Save Data**.
- 3 In the **Save Data** dialog, enter `fit_constant` as the data name.

Rerun Fit With Exponential Error Model

After you save the data, you can rerun the fit program with a different error model.

- 1 Return to the fit program by clicking the **Program2** tab. In the **Error Model** section, select **exponential**.

ERROR MODEL
Use the same error model for each response : constant

ESTIMATION METHOD

Use a global solver

lsqnonlin fminunc lsqcurvefit

fminsearch fmincon

constant
proportional
exponential
combined

- 2 At the top of the **Fit** step, click the **Run this program step** button.

FIT

DESCRIPTION
Click to edit the description

STATISTICAL MODELING
non-linear regressions

- 3 Close the progress plot after the fit completes.
- 4 If you closed the previous datasheet (**Datasheet3**) that contains the fit statistics from the previous fit, reopen the datasheet. To do so, in the **Browser** pane, expand **Program2 > fit_constant**. Then double-click **Datasheet3**.
- 5 From the **LastRun** folder, drag **results** onto **Datasheet3**. New columns (**Program2_LastRun**) containing the latest fit results are added next to the previous fit results (**Program2_fit_constant**).

The screenshot shows the SimBiology interface. On the left is a 'Browser' window displaying a project hierarchy. The 'results' file under 'Program2' is highlighted with a red box. A red arrow points from this box to the 'Statistics' table on the right. The right side of the interface shows two tables: 'Pooled Parameter Estimates' and 'Statistics'.

Pooled Parameter Estimates (Program2: fit_constant)

	Name	Estimate	StandardError
1	k1	0.4635	0.0328
2	Cl_Central	0.6747	0.0110
3	L0	0.5453	0.2075
4	L1	0.2697	0.0209
5	k12	0.0116	8.5571e-4
6	k21	0.0645	0.0045

Statistics (Program2: fit_constant)

	Name	Value
1	AIC	534.7027
2	BIC	556.2037
3	LogLikelihood	-261.3513
4	DFE	260
5	MSE	0.4274
6	SSE	111.1263

The table is updated as follows.

Pooled Parameter Estimates

	Name	Program2_fit_constant		Program2_LastRun	
		Estimate	StandardError	Estimate	StandardError
1	k1	0.4635	0.0328	0.4643	0.0106
2	Cl_Central	0.6747	0.0110	0.6672	0.0077
3	L0	0.5453	0.2075	0.5687	0.0102
4	L1	0.2697	0.0209	0.2690	0.0038
5	k12	0.0116	8.5571e-4	0.0108	3.6005e-4
6	k21	0.0645	0.0045	0.0588	0.0018

Statistics

	Source	AIC	BIC	LogLikelihood	DFE
1	Program2_fit_constant	534.7027	556.2037	-261.3513	260
2	Program2_LastRun	-36.2271	-14.7262	24.1136	260

Pooled Beta

	Name	Program2_fit_constant		Program2_LastRun	
		Estimate	StandardError	Estimate	StandardError
1	log(k1)	-0.7689	0.0707	-0.7673	0.0228
2	log(Cl_Central)	-0.3935	0.0163	-0.4047	0.0116
3	log(L0)	-0.6063	0.3806	-0.5644	0.0180
4	log(L1)	-1.194	0.077	-1.3129	0.0141

The **Statistics** table compares the fit quality measures. From the comparison, both the AIC and BIC of the fit using the exponential error model are smaller than those of the previous fit. This indicates that the exponential error model fits the data better than the constant error model. The larger log likelihood of the exponential error model also indicates it is a better fit.

- Next, look at the residual distribution plot. Click **results** from the **LastRun** folder. Then click **Residual Dist** from the **Plot** section on the **Home** tab.

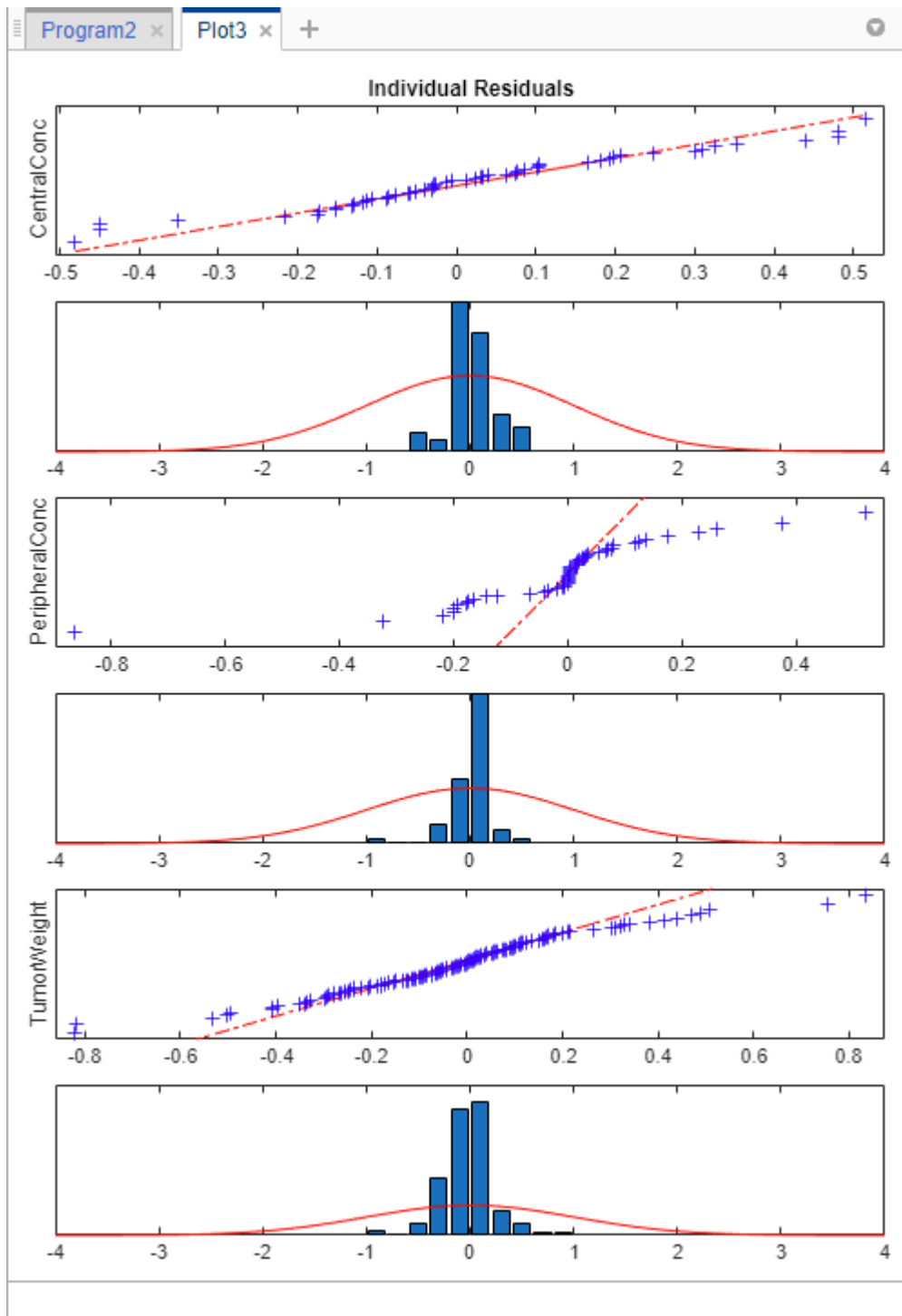

Compared to the residual distributions of the constant error model, the residual distributions from the exponential error model look more normal, indicating that the exponential error model fits the data better.

Calculate Confidence Intervals

Another way to assess the quality of fit results is to compute 95% confidence intervals for the estimated parameters and model predictions — that is, model simulation results using the estimated parameters. This step requires Statistics and Machine Learning Toolbox.

- 1 Click the **Program2** tab. Click the green (+) icon at the upper left and select **Confidence Interval**. A **Confidence Interval** step appears following the **Fit** step.

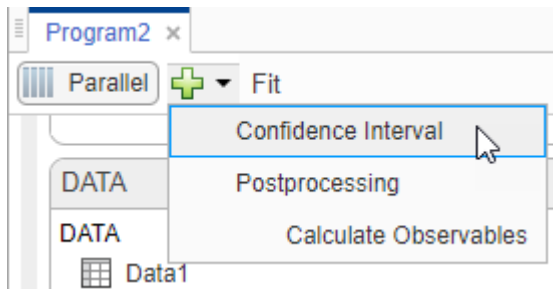

- 2 At the top of the **Confidence Interval** step, disable the autogeneration of plots by clicking the plot icon. For both **Parameter Confidence Intervals** and **Prediction Confidence Intervals**, use the default method **gaussian** and 95% confidence level. Click the **Run this program step** button to compute confidence intervals.

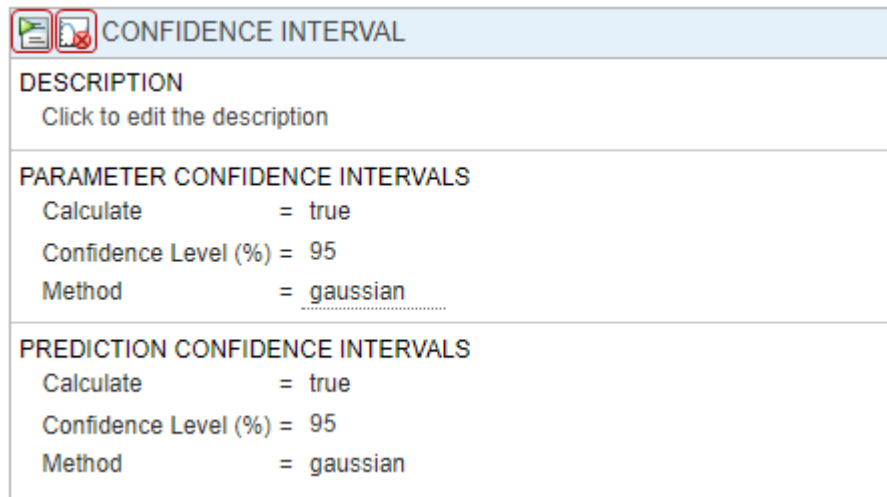

For parameter confidence intervals, the supported methods are **gaussian**, **profileLikelihood**, and **bootstrap**.

For prediction confidence intervals, the supported methods are **gaussian** and **bootstrap**.

- 3 Once completed, the results are stored as *parameterCI* and *predictionCI* in the **LastRun** folder of the program. *parameterCI* contains 95% confidence intervals for the estimated parameters. *predictionCI* contains 95% confidence intervals for the model predictions.
- 4 Plot 95% confidence intervals for the estimated parameters. Click *parameterCI* in the **Browser** pane and select **Confidence** in the **Plot** section.

The screenshot displays the SimBiology software interface. At the top, the 'HOME' ribbon contains several icons: 'Open', 'Save', 'Close', 'Model', 'Data', 'Program', 'New Datasheet', and 'New Plot'. A 'Confidence' plot icon is highlighted with a red box. Below the ribbon is the 'Browser' pane, which shows a tree view of the project structure. The 'parameterCI' entry is highlighted with a red box. To the right, the 'PLOT' pane shows the 'Confidence' plot, which displays a bar chart with error bars for each parameter. The 'parameterCI' entry in the browser table is highlighted with a red box.

Name	Size	Type
Project		project
Models	1x1	
Data1	152x8	table
Program1		nca
LastRun		
Program2		fit
LastRun		
results	1x1	SimBiology.fit.OptimResults
simdata1	8x1	SimData
parameterCI	1x1	SimBiology.fit.ParameterConfidenceInterval
predictionCI	1x1	SimBiology.fit.PredictionConfidenceInterval

The confidence interval for each estimated parameter is shown in a new plot. The plot indicates the successful computation of the confidence intervals for all estimated parameters.

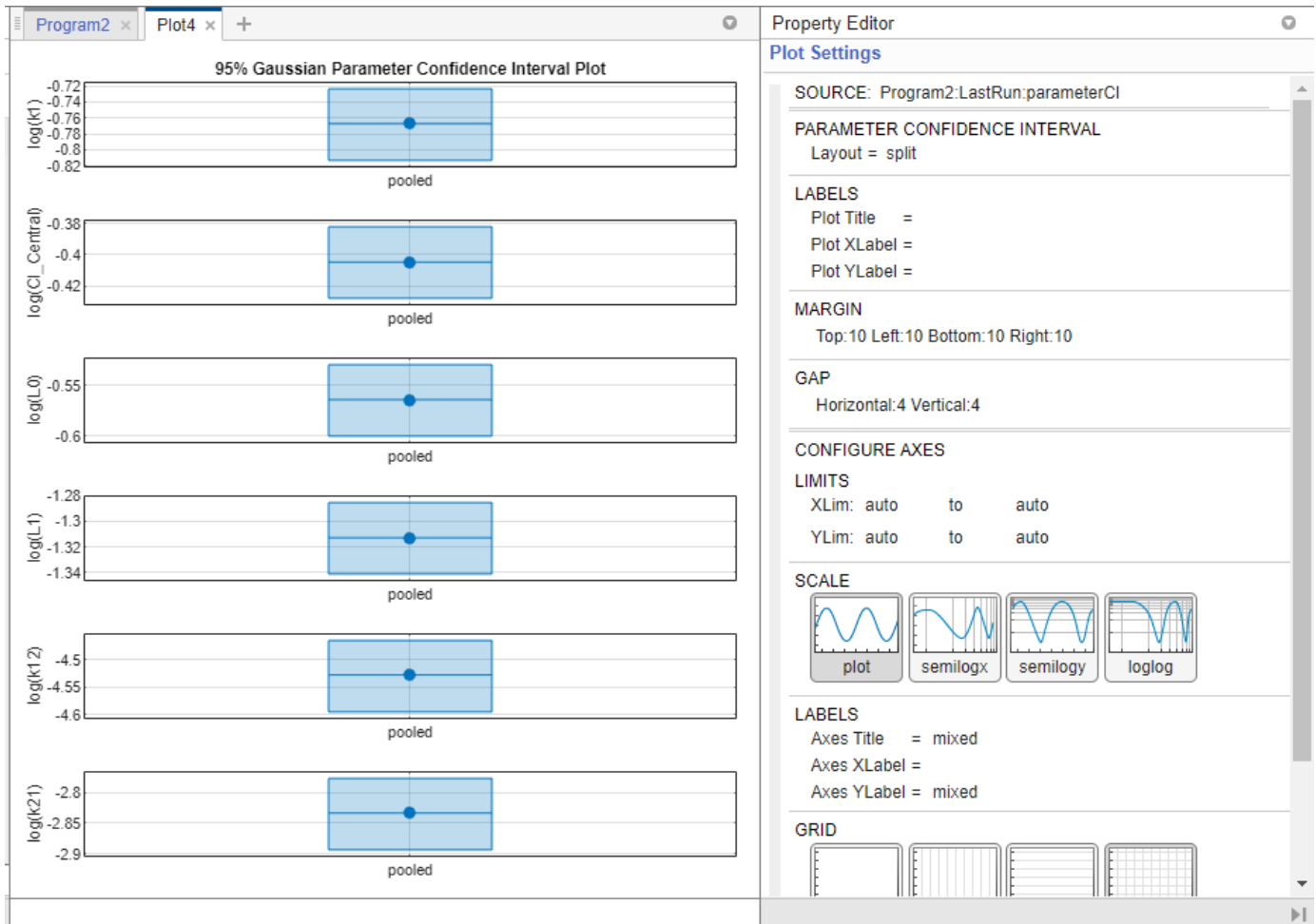

Depending on the outcome (status) of the confidence interval estimation, the app plots the results differently.

- If the status of confidence interval estimation is a *success* (as in the above plot), the app uses the first default color (blue) to plot a line and a centered dot for every parameter estimate. The app also plots a box to indicate the confidence intervals.
- If the status is *constrained* or *estimable*, the app uses the second default color (red) and plots a line, centered dot, and box to indicate the confidence intervals.
- If the status is *not estimable*, the app plots only a line and a centered cross in red.
- If there are any transformed parameters with estimated values that are 0 (for the \log transform) and 0 or 1 (for the probit or logit transform), no confidence intervals are plotted for those parameter estimates.

For more details on the definitions of different statuses, see "Parameter Confidence Interval Estimation Status".

You can also change the **Layout** of the plot in **Plot Settings**.

- The '`split`' layout displays the confidence interval for each parameter estimate on a separate axis.

- The 'grouped' layout displays all confidence intervals on one axis, grouped by parameter estimates. Each estimated parameter is separated by a vertical black line.

In both cases, the parameter bounds defined in the original fit are marked by square brackets. The app uses vertical dotted lines to group confidence intervals of parameter estimates that have been computed in a common fit.

- 5 Similarly, plot 95% confidence intervals for the model predictions. Click *predictionCI* in the **Browser** pane and select **Confidence** in the **Plot** section.

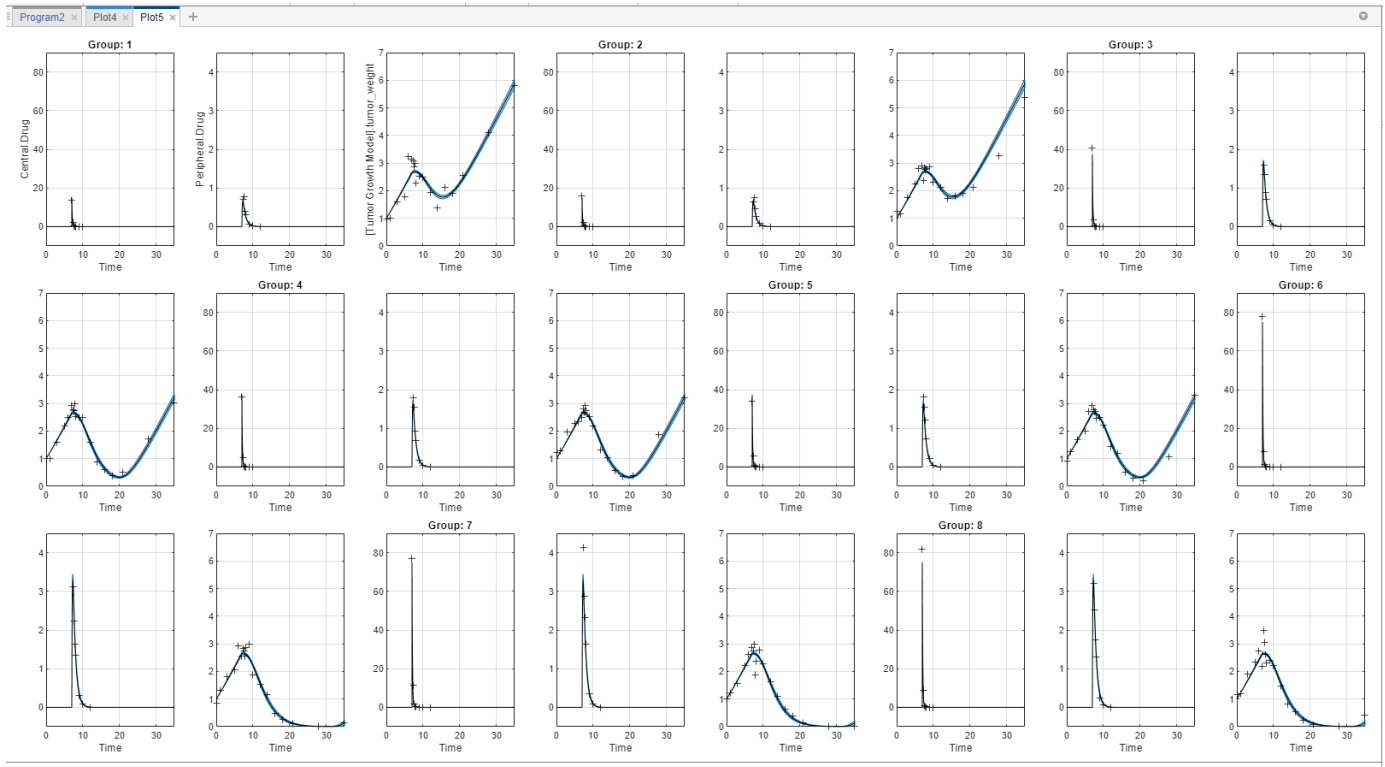

The plot indicates the successful computation of the confidence intervals because there are no red plot. The plotting behavior differs depending on the outcome (status) of the confidence interval calculation.

- If the status is *constrained* or *not estimable*, the app uses the second default color (red) to plot the confidence intervals.
- Otherwise, the app uses the first default color (blue) and plots the confidence intervals as shaded areas (as in the above plot).

For details, see “Gaussian Confidence Interval Calculation for Model Predictions” and “Bootstrap Confidence Interval Calculation”.

Visualize Simulation Statistics and Overlay Experimental Data Using Percentile Plot

The percentile plot lets you visualize simulation results and statistics that can be overlaid with experimental data. For example, you can plot 5th and 95th percentile curves of simulation data over time instead of seeing the individual time plots. You can also visualize the mean, standard deviation, minimum, and maximum of simulation and experimental data. For details, see “Percentile Plot” on page 1-126.

Note If you have not completed the prior steps that generated the required results to continue, you can load the completed project instead.

- 1 Open the SimBiology Model Analyzer app.
- 2 Click **Open** and navigate to the folder `matlabroot\examples\simbio\data\`. `matlabroot` is the folder where you have installed MATLAB. Select the project file named `tumor_growth_fitPKPD_completed.sbproj`.

- 1 In the **LastRun** folder of **Program2**, select **simData1** > **[Tumor Growth Model].tumor_weight**.

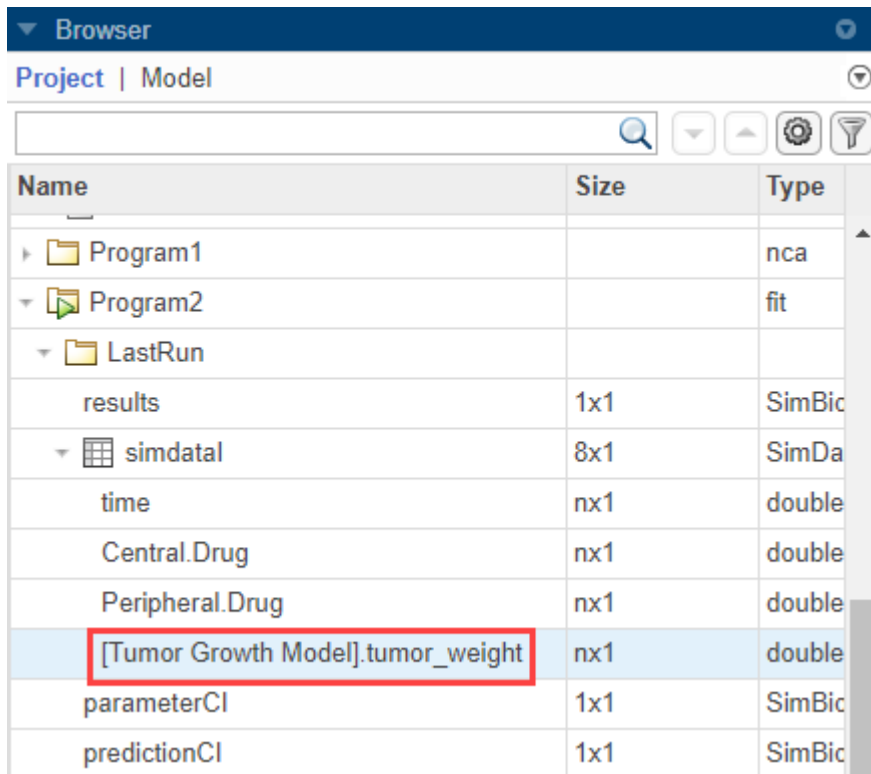

- 2 On the **Home** tab, click **percentile**.

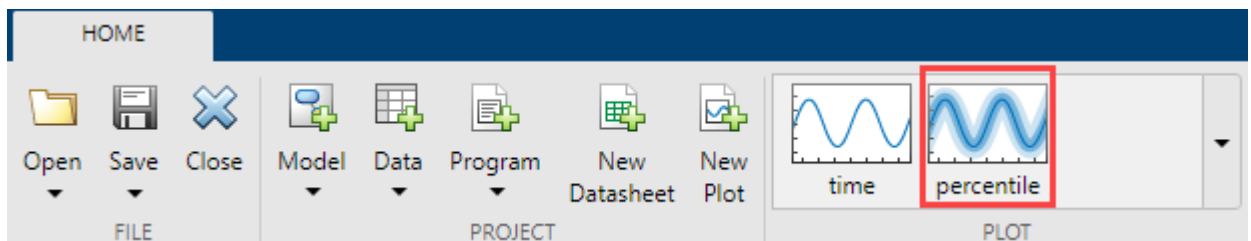

The percentile plot shows the 5th and 95th percentile curves by default.

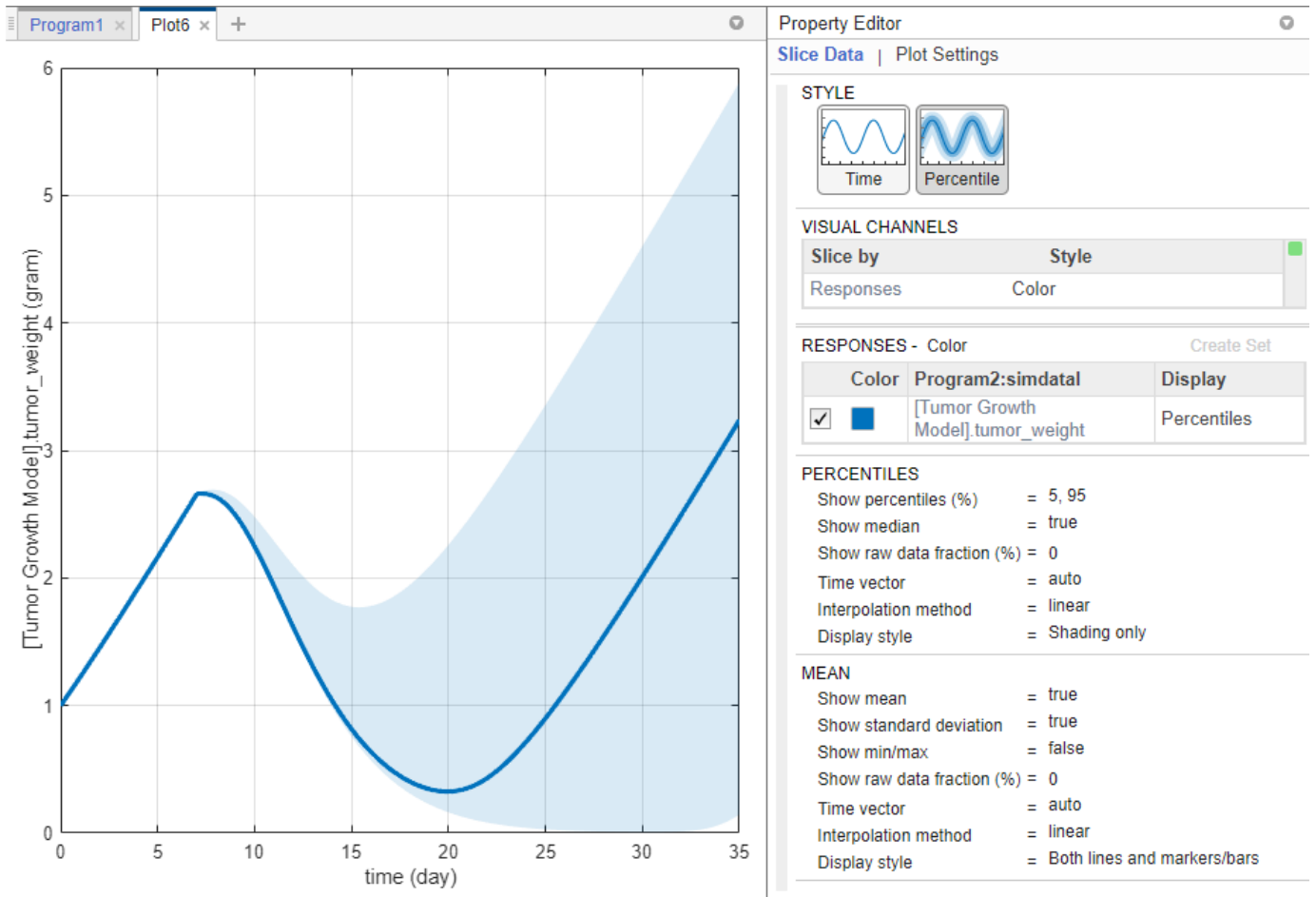

3 Select **Data1 > TumorWeight**. Drag and drop it on to the plot.

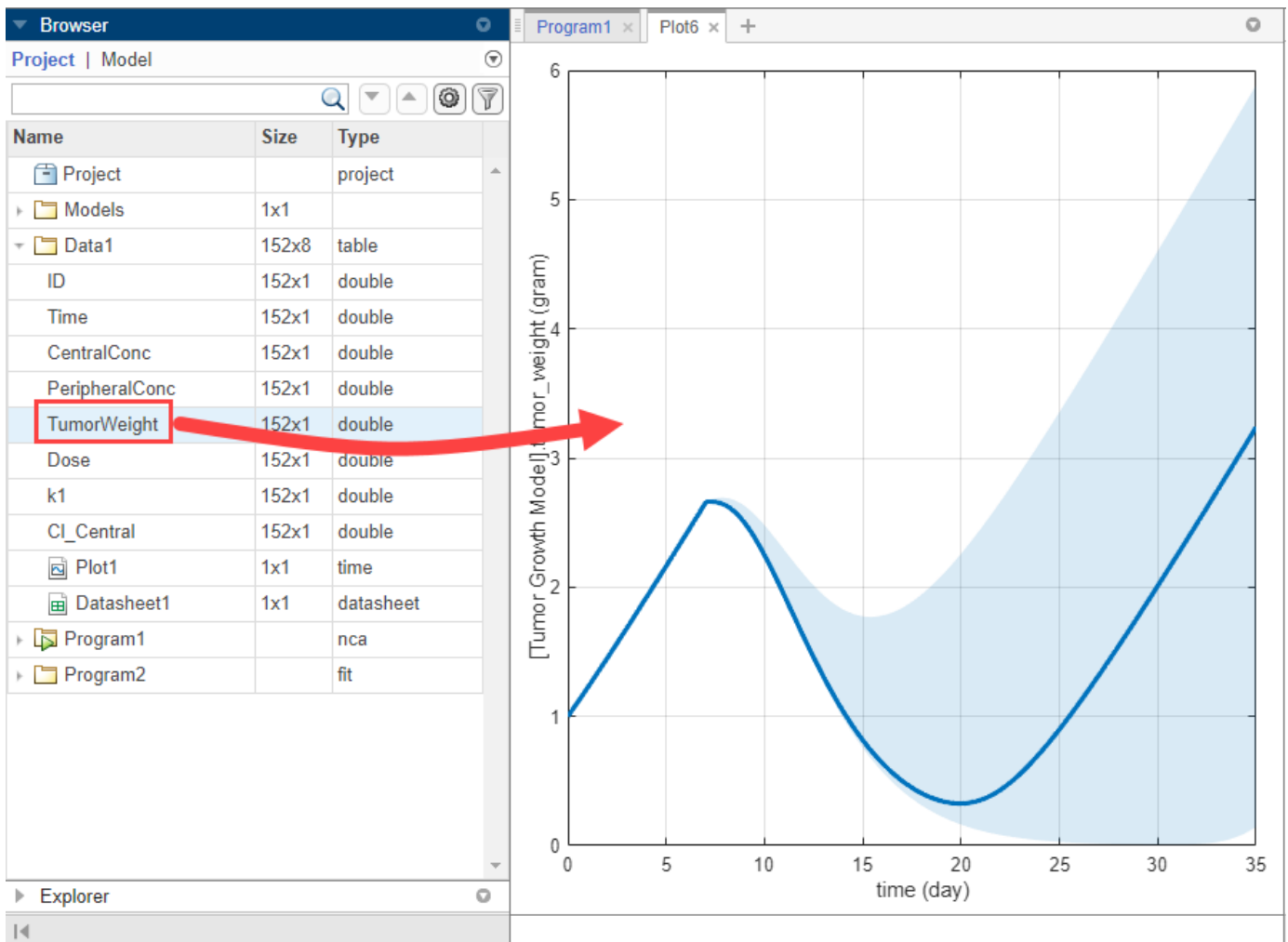

By default, the **Display** type of the experimental data is automatically set to **Mean**, which shows the mean measurement at each time with ± 1 standard deviation. If you want to visualize the original data points, double-click **Mean** and select **Raw Data**. For this example, keep the **Mean** display.

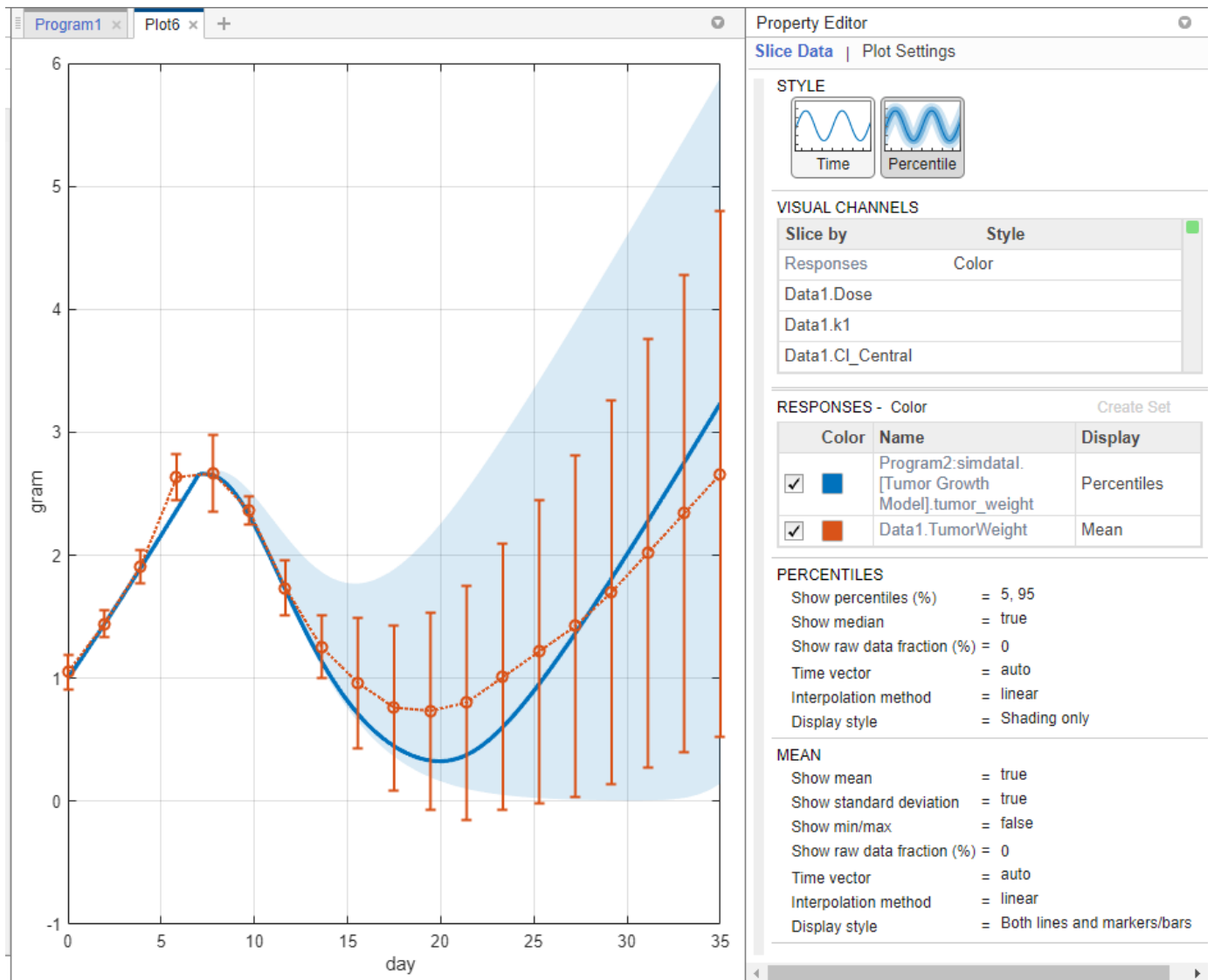

- 4 In the **Percentiles** section, for the **Show percentiles (%)** option, enter 10, 80 to show the 10th and 80th percentiles.
- 5 Change **Display style** to Both lines and shading.

PERCENTILES

Show percentiles (%) = 10, 80

Show median = true

Show raw data fraction (%) = 0

Time vector = auto

Interpolation method = linear

Display style = Both lines and shading

- 6 In the **Mean** section, show the minimum and maximum response data points at each time by setting **Show min/max** to `true`. Also show all the underlying raw data points by changing **Show raw data fraction (%)** to 100. You can also enter a custom percentage number.

MEAN

Show mean	=	true
Show standard deviation	=	true
Show min/max	=	true
Show raw data fraction (%)	=	100
Time vector	=	auto
Interpolation method	=	linear
Display style	=	Both lines and markers/bars

The percentile plot is updated as follows. The asterisks (*) represent the calculated minimum and maximum values after interpolation, and the dots (.) represent original data points. Because these minimum and maximum values are computed based on an interpolated common time vector, the values do not match exactly with those of raw data. For details, see “Mean Options” on page 1-127.

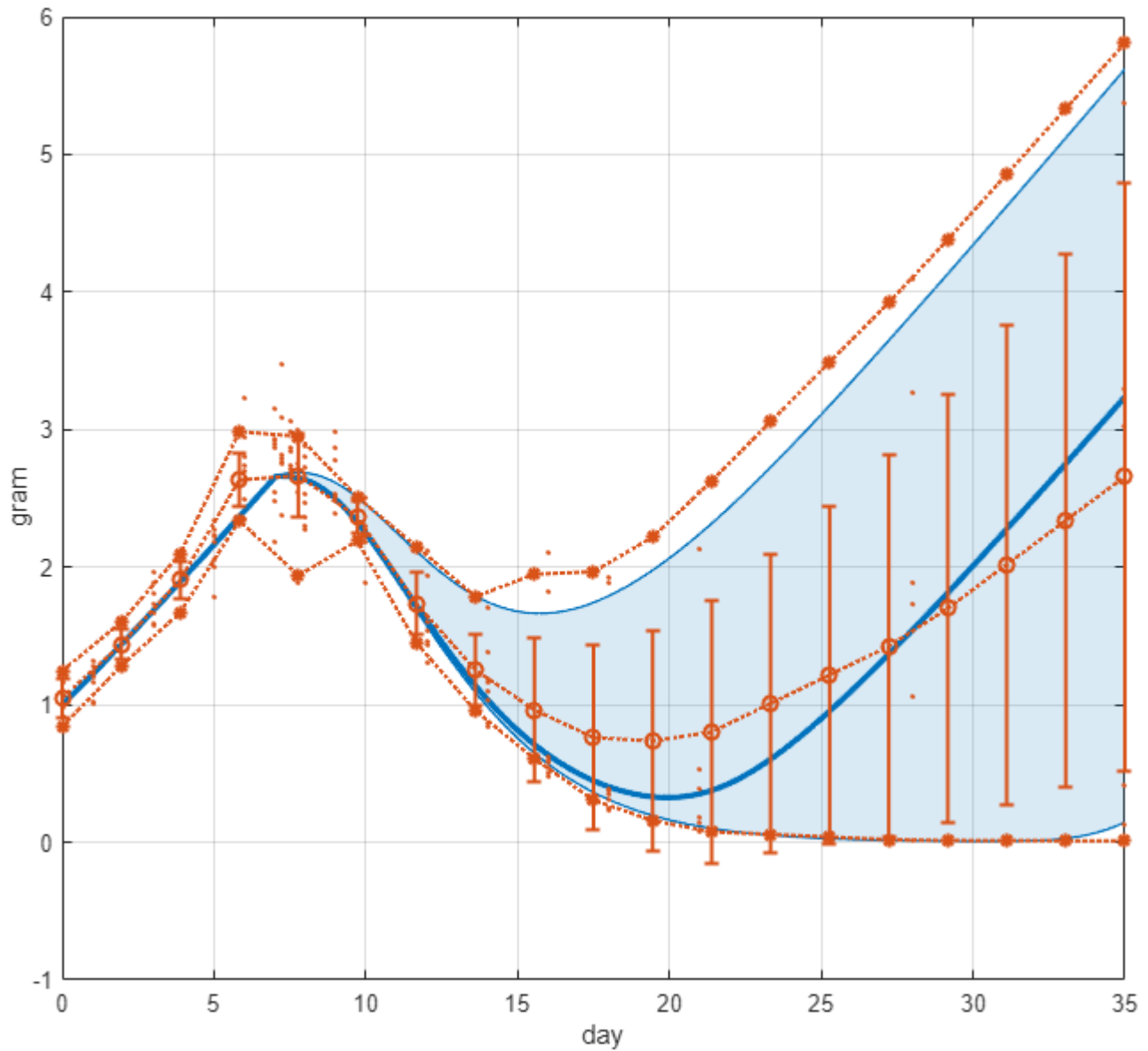

After parameter estimation, you can set the model values to the parameter estimates and perform other analyses. For instance, you can find out important model parameters using sensitivity analysis on page 1-41 and vary the sensitive parameters to investigate model variability by using virtual patients on page 1-61.

References

- [1] Simeoni, Monica, Paolo Magni, Cristiano Cammia, Giuseppe De Nicolao, Valter Croci, Enrico Pesenti, Massimiliano Germani, Italo Poggesi, and Maurizio Rocchetti. "Predictive Pharmacokinetic-Pharmacodynamic Modeling of Tumor Growth Kinetics in Xenograft Models after Administration of Anticancer Agents." *Cancer Research* 64, no. 3 (February 1, 2004): 1094-1101.

See Also

SimBiology Model Analyzer

More About

- “Find Important Parameters with Local Sensitivity Analysis Using SimBiology Model Analyzer App” on page 1-41
- “Model Biological Variability with Virtual Patients Using SimBiology Model Analyzer App” on page 1-61
- “Scan Dosing Regimens Using SimBiology Model Analyzer App” on page 1-108

Scan Dosing Regimens Using SimBiology Model Analyzer App

This example shows how to assess the efficacy and toxicity of various dose amounts in the **SimBiology Model Analyzer** app by using the target (receptor) occupancy as a biomarker. The example uses the target-mediated drug disposition (TMDD) model [1] with slight modifications.

Target-Mediated Drug Disposition (TMDD) Model

Target-mediated drug disposition (TMDD) is a phenomenon in which a drug binds with high affinity to its pharmacologic target site, such as a receptor or enzyme, in an interaction that is reflected in the pharmacokinetic characteristics of the drug.

This example uses a modified TMDD model based on the model used by Mager and Jusko [1] with a minor adjustment. The authors proposed a generic TMDD model that accounted for saturable drug-target binding and target (or receptor) mediated elimination. Drug in the Plasma reversibly binds with the unbound Target to form the drug-target Complex. k_{on} and k_{off} are the association and dissociation rate constants, respectively. Clearance of free Drug and Complex from the Plasma is described by first-order processes with rate constants — k_{el} and k_m , respectively. Free target turnover is described by the zero-order synthesis rate k_{syn} and a first-order elimination (the rate constant, k_{deg}). Variants of the TMDD model have been since used to characterize the pharmacokinetics of numerous drugs.

The adjustment made to the model presented by Mager and Jusko, is as follows.

- Target occupancy (TO) is modeled as $TO = \text{Complex} / (\text{Target} + \text{Complex})$, where TO is a parameter and Complex and Target are species.

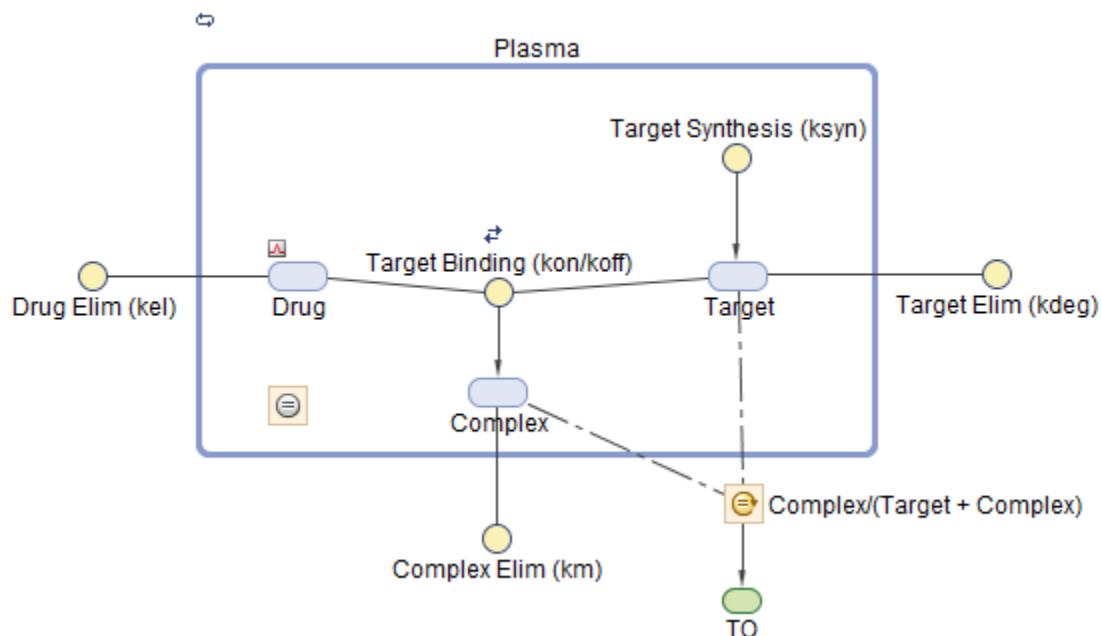

Explore Model Response Using Different Dose Amounts

Investigate the model response on the target occupancy (TO) using different dose amounts.

Load TMDD Model

At the MATLAB command line, enter:

```
simBiologyModelAnalyzer("tmdd_with_T0.sbproj")
```

Generate Array of Doses and Simulate Model

First, create a program to generate an array of doses with different dose amounts ranging from 0 to 300 nanomoles.

- 1 Select **Program > Generate Samples**.
- 2 In the **Generate Samples** step, double-click the empty cell under **Component Name** and enter **Daily Dose.Amount**.
- 3 Under **Daily Dose.Amount**, set **Type** to **MATLAB Code**, and set **Code** to `linspace(0,300,31)`. This code specifies the generation of 31 doses with amounts ranging from 0 to 300 nanomoles.
- 4 Disable the plotting of dose samples by clicking the plot button, as shown in the figure.

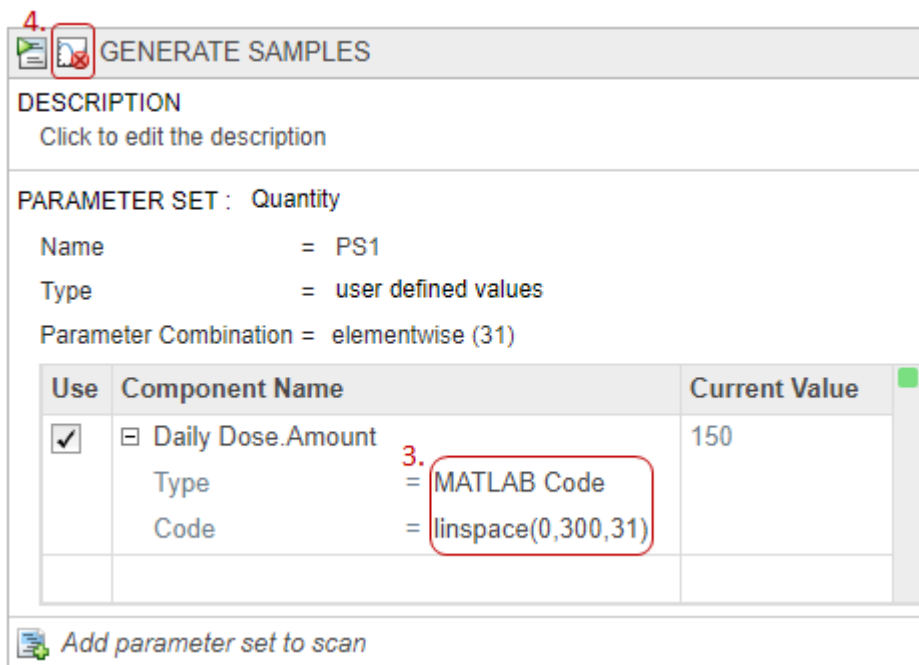

- 5 Add a simulation step to simulate the model using the defined doses. Click the (+) icon at the upper left of the program and select **Simulation**. A **Simulation** step appears following the **Generate Samples** step.

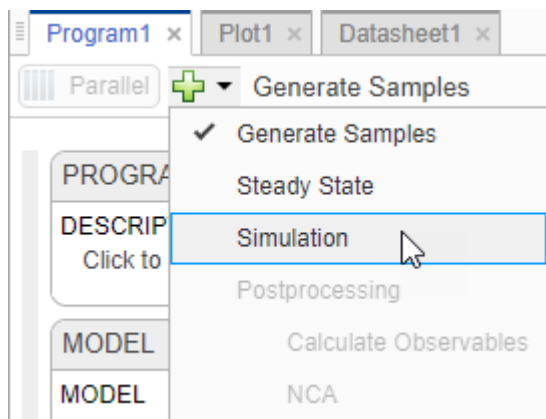

- 6 In the **Model** step, click **States to Log**. Select **TO** as the only state to log by clearing all other check boxes.
- 7 On the **Home** tab, click **Run**.

Once the simulation is complete, the program plots the results in **Plot1**, which shows the time course of the model response (*TO*) given different dose amounts.

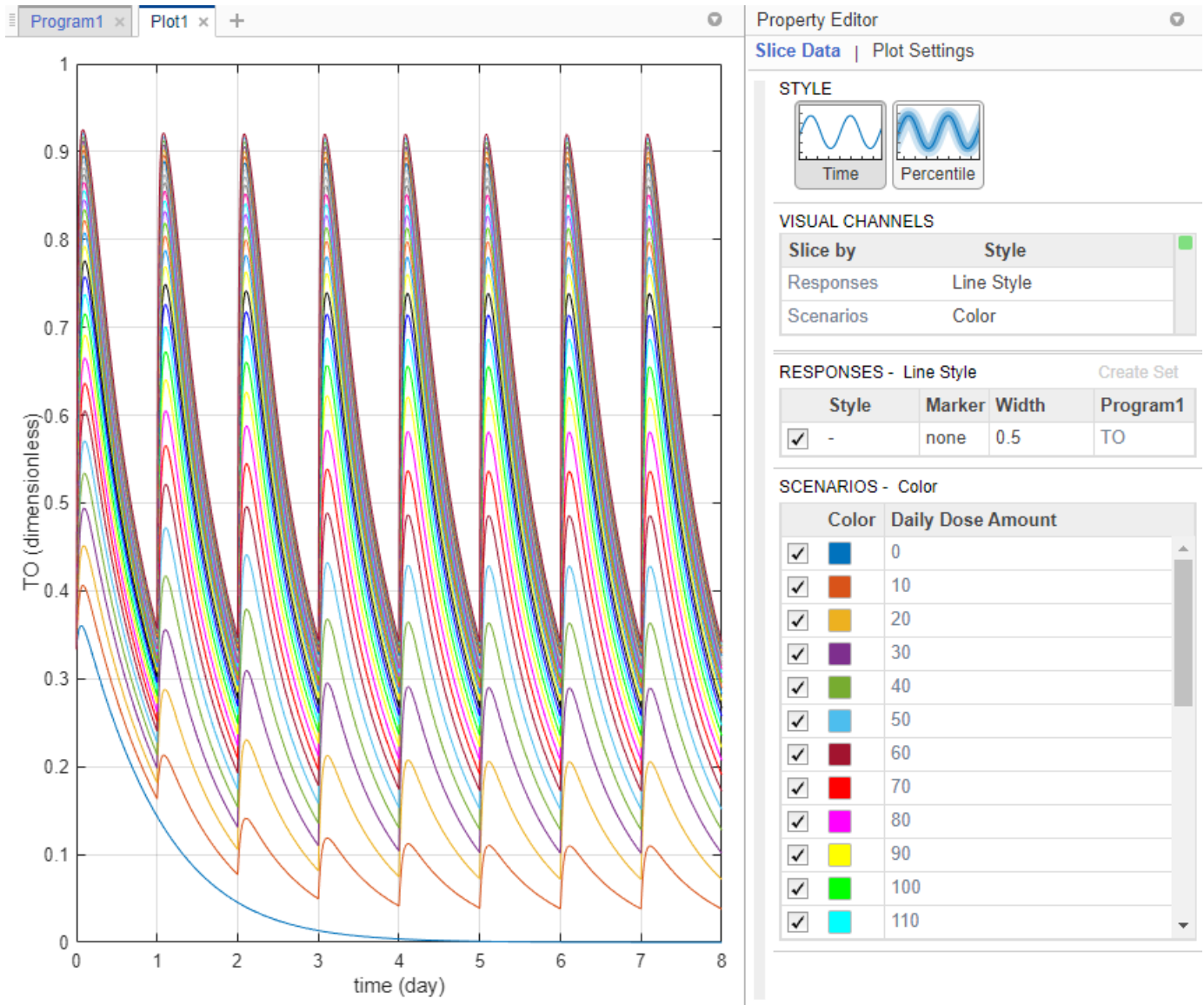

Tip Plots are backed by data that are currently present in the app workspace. Plots are not snapshots. When the data (either experimental data or simulation results) is removed or changed, the plots are also updated according to the changes in the underlying data.

Define Maximum and Minimum Target Occupancy Thresholds

Investigate which dose amounts correspond to the *TO* responses that lie within the safety ($TO = 0.85$) and efficacy ($TO = 0.15$) thresholds. One approach is to add two (horizontal) threshold lines to the *TO* response plot.

- 1 On the **Home** tab, in the **Project** section, click **New Datasheet**.
- 2 In the **Browser** pane, expand the **Program1** folder, then expand the **LastRun** folder.
- 3 Drag **results** into the new datasheet. The datasheet now shows **time** and **TO** columns with their corresponding values.

Program1: LastRun: results *Units are being converted for the simulation data (SimData).*

		time	TO
		independent	dependent
		day	dimensionless
1	1	0	0.3333
2	1	0	0.3333
3	1	4.8149e-5	0.3334
4	1	9.6299e-5	0.3334
5	1	2.2248e-4	0.3336
6	1	3.4867e-4	0.3338
7	1	4.7485e-4	0.3339
8	1	6.0104e-4	0.3341
9	1	8.7413e-4	0.3344
10	1		

- Point to the table and add an expression by clicking the (+) icon that appears at the top right.

TO
dependent
dimensionless
0.3333
0.3333

Add an expression column

Note Anytime you add an expression to a datasheet containing results from **LastRun**, the expression is added as an observable object to the model. In addition, the **Postprocessing: Calculate Observables** step is also added to the corresponding program that generated the **LastRun** data.

- Double-click **Name1** and rename it **EfficacyThreshold**.
- Double-click **UNITS** and enter **dimensionless**.
- Double-click the **Expression** cell and enter **0.15**. The expression fills the column with the same constant value (0.15) for every time point.
- Similarly, add another expression column named **SafetyThreshold** with the expression **0.85**. Expand **results** in the **LastRun** folder. The values from these two expression columns are scalar-valued observables and now stored in the table named **scalars** under **results**.

time		TO	EfficacyThreshold	SafetyThreshold	
independent		dependent	dependent	dependent	
day		dimensionless	dimensionless	dimensionless	
			0.15	0.85	
1	1	0	0.3333	0.1500	0.8500
2	1	0	0.3333	0.1500	0.8500
3	1	4.8149e-5	0.3334	0.1500	0.8500
4	1	9.6299e-5	0.3334	0.1500	0.8500
5	1	2.2248e-4	0.3336	0.1500	0.8500
6	1	3.4867e-4	0.3338	0.1500	0.8500
7	1	4.7485e-4	0.3339	0.1500	0.8500
8	1	6.0104e-4	0.3341	0.1500	0.8500
9	1	8.7413e-4	0.3344	0.1500	0.8500
10	1	0.0015	0.3351	0.1500	0.8500
11	1		0.3358		0.8500

You can now plot the maximum and minimum threshold lines on to the existing plot **Plot1**.

- Click the **Plot1** tab. Press **Ctrl** and select **EfficacyThreshold** and **SafetyThreshold** variables from the **Browser** pane. Drag them into the plot. The plot now shows **TO** profiles along with the efficacy and safety threshold lines.

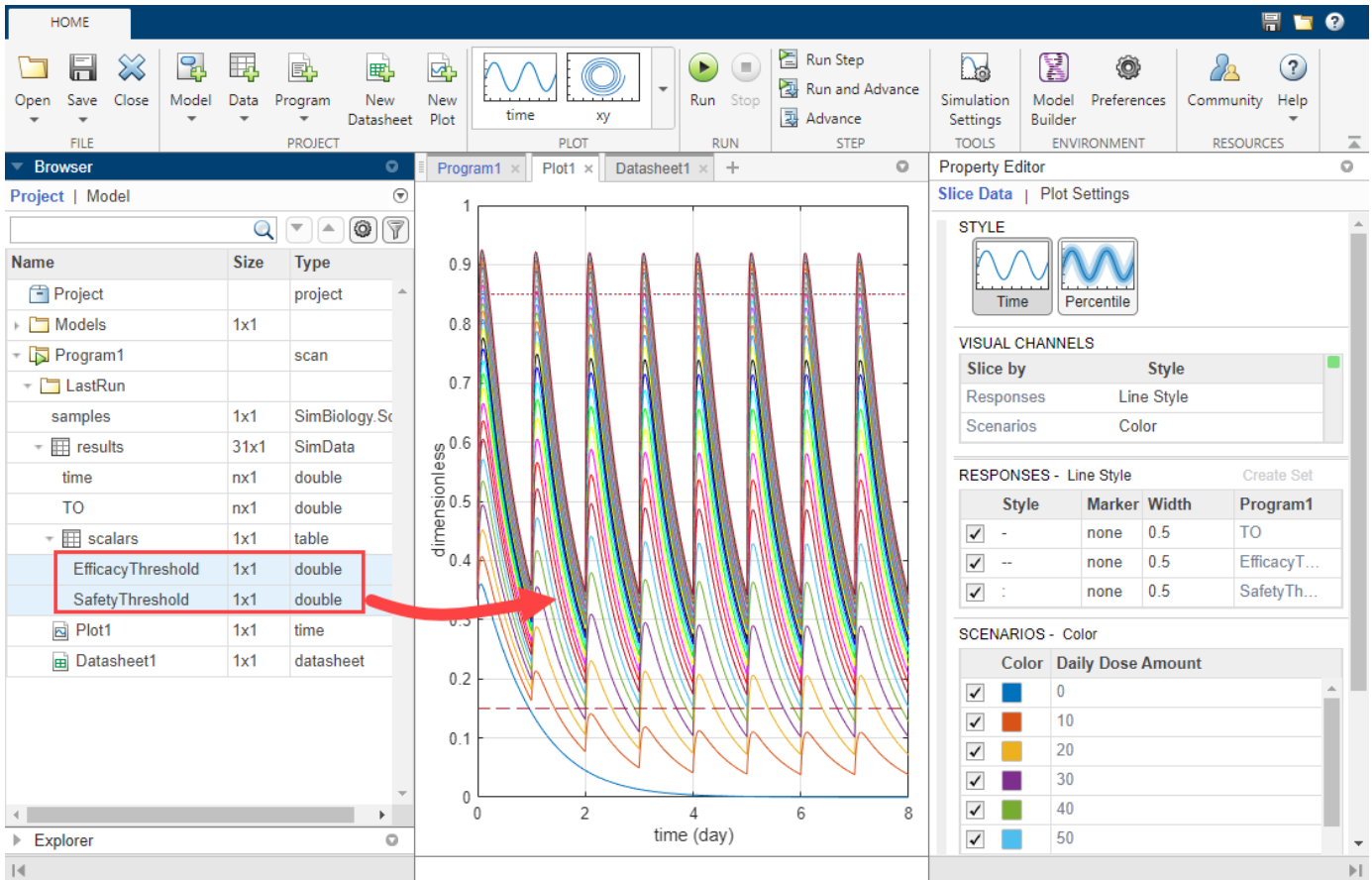

Visualize Target Occupancy Responses on Separate Axes

The plot shows that certain *TO* responses either exceed the safety threshold or dip below the efficacy threshold. To better visualize this observation, you can customize the plot to see each dose amount and the corresponding *TO* response on separate axes.

- 1 In the **Property Editor**, in the **Visual Channels** table, set **Responses** to **Color** and **Scenarios** to **Grid**.

Slice by	Style
Responses	Color
Scenarios	Grid

- 2 Click **Plot Settings**. For **Plot YLabel**, enter *TO* as the value.
- 3 In the **Axes Limits** section, select **Link Y-Axis** to show the same set of labels on the *y*-axis for all subplots.

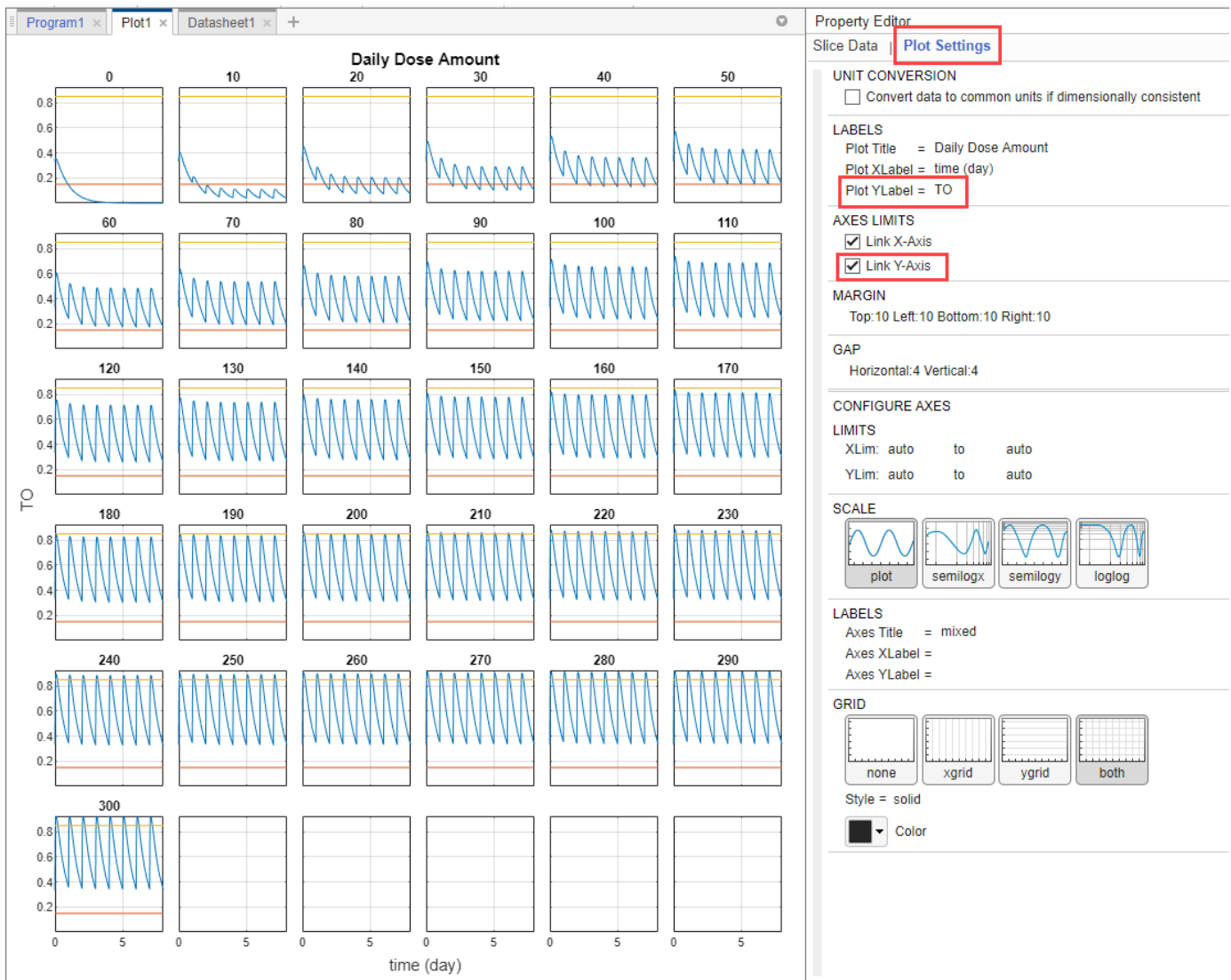

Postprocess Simulation Results

In addition to visually inspecting each response plot on separate axes, you can add a postprocessing step to query exactly which dose amounts stay within the thresholds.

- 1 Click the **Program1** tab. In the **Postprocessing: Calculate Observables** step, double-click the first empty cell in the **Name** column and enter: `feasible_doses`.
- 2 In the **Expression** column, enter `max(T0) < 0.85 & min(T0) > 0.15`. Set unit to dimensionless.

Note Anytime you add an expression to the **Observables** table in the step, the expression is automatically added as an observable object to the corresponding model.

- 3 Select `feasible_doses` as the only observable. Clear `EfficacyThreshold` and `SafetyThreshold`.

- 4 To evaluate `feasible_doses`, run just the simulation step by clicking the run button at the top of the **Simulation** step.

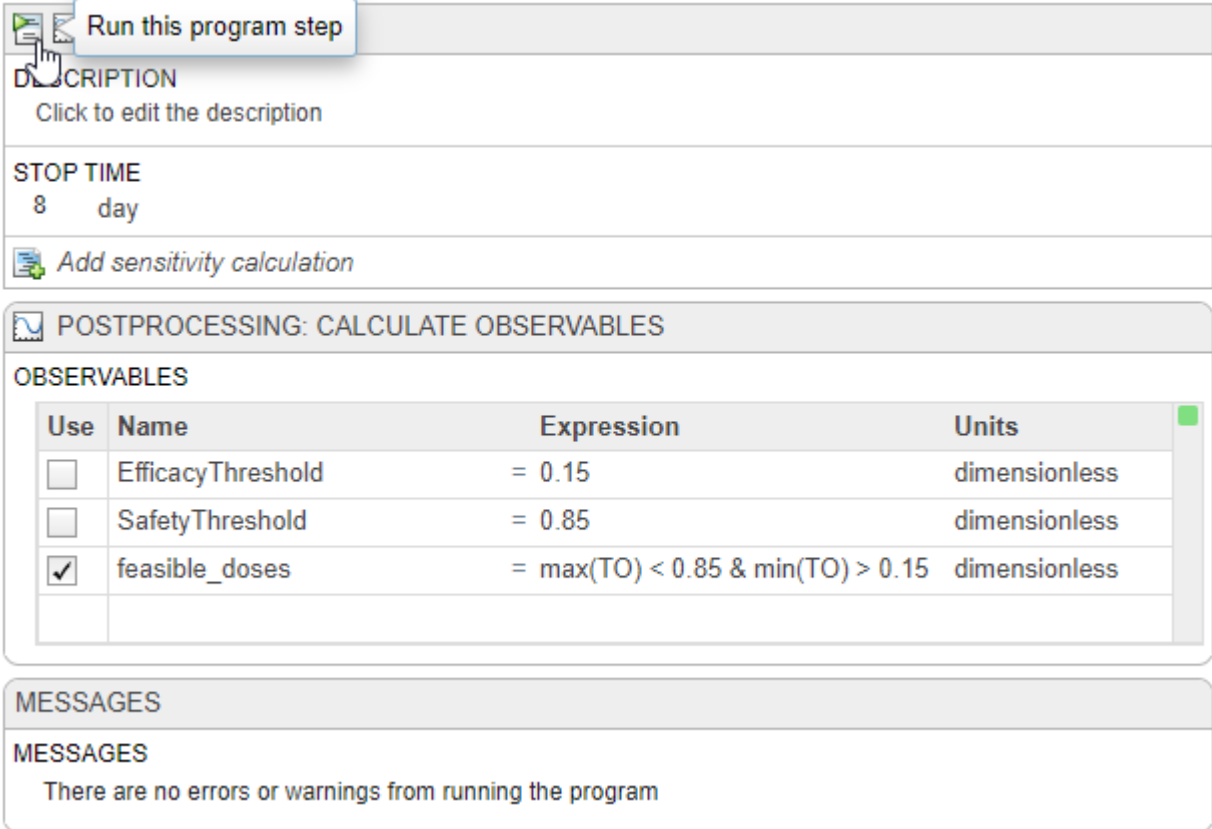

The screenshot shows the SimBiology interface. At the top, there is a button labeled "Run this program step" with a play icon. Below it, the "DESCRIPTION" section contains the text "Click to edit the description". The "STOP TIME" is set to "8 day". There is a link to "Add sensitivity calculation". The "POSTPROCESSING: CALCULATE OBSERVABLES" section is expanded, showing a table of observables:

Use	Name	Expression	Units
<input type="checkbox"/>	EfficacyThreshold	= 0.15	dimensionless
<input type="checkbox"/>	SafetyThreshold	= 0.85	dimensionless
<input checked="" type="checkbox"/>	feasible_doses	= max(TO) < 0.85 & min(TO) > 0.15	dimensionless

Below the table is the "MESSAGES" section, which displays the message: "There are no errors or warnings from running the program".

Running the program step generates the following figure. You might see a warning about dimensional analysis not being able to performed. For the purposes of this example, you can ignore the warning.

Display both the x-grid and y-grid by clicking **both** in the **Grid** section. The x-axis represents the dose amounts and the y-axis represents whether the dose amount generates a *TO* response that stays within the safety and efficacy thresholds (with a value of 1) or not (with a value of 0).

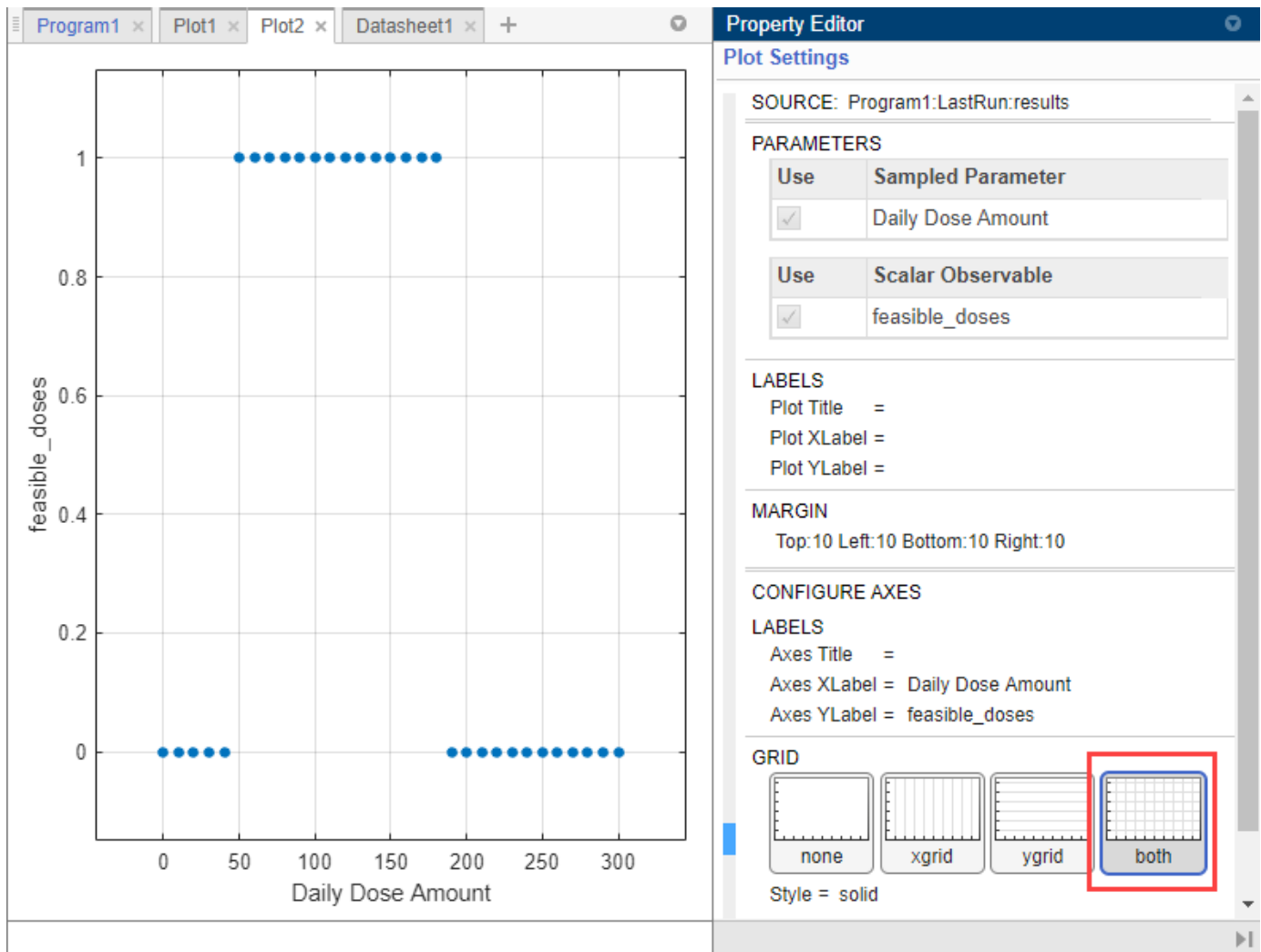

The plot shows that dose amounts ranging from 50 to 180 nanomoles provide *TO* responses that lie within the desired efficacy and safety thresholds.

See Also

simbiology | Observable | **SimBiology Model Analyzer**

More About

- “Calculate NCA Parameters and Fit Model to PK/PD Data Using SimBiology Model Analyzer App” on page 1-77
- “Find Important Parameters with Local Sensitivity Analysis Using SimBiology Model Analyzer App” on page 1-41
- “Model Biological Variability with Virtual Patients Using SimBiology Model Analyzer App” on page 1-61

References

- [1] Marger, D., and W. Jusko. 2001. General pharmacokinetic model for drugs exhibiting target-mediated drug disposition. *Journal of Pharmacokinetics and Pharmacodynamics*. 28: 507-532.

Undo and Redo Model Changes in SimBiology

While a model is open in one (or both) of the SimBiology apps, you can undo and redo model building and diagram configuration actions you take in the apps or at the command line. Model building activities include changes to the model, variants, doses, and `configset` object (**Simulation Settings**). Model diagram configuration actions include joining and splitting species blocks, and making changes to block and line properties, such as to block position, block shape, and line color.

Regardless of whether you perform the actions in the apps or at the command line, you can undo them only by using the **Undo** or **Redo** button in the **SimBiology Model Builder** app.

The action history for undo and redo is model-specific. Hence, if you have several models in a project, each model maintains its own list of actions for undoing or redoing. Removing a model from a project clears the action history for that model. Closing both apps clears all the action histories for all models in the project.

Each time you undo or redo, the **Model Builder** app:

- 1 Shows a message in the status bar indicating what the last modification was.
- 2 Changes the focus as follows:
 - If a model property or model diagram is changed, the **Diagram** tab is open and selected.
 - If a variant property is changed, the **Variants** tab is open and selected.
 - If a dose property is changed, the **Doses** tab is open and selected.
 - If the change is in the model `configset` object (or **Simulation Settings** of the app), the app shows only the message in the status bar and does not change the focus.

Model Changes in Model Analyzer App

You can undo model changes made within the **Model Analyzer** app. You still need to use the **Undo** and **Redo** buttons in the **Model Builder** app. Specifically, you can undo the following actions originating from the **Model Analyzer** app:

- Adding or modifying observables in the **Postprocessing: Calculate Observables** step
- Committing slider values for quantities and doses from the **Explorer** to the model
- Creating variants from the slider, estimated parameter values, or simulation data

Undo Deletion of Model Components

You can undo and redo the deletion of model components (such as species or parameters) of a model but the deletion of a model object is not supported for undoing and redoing. You can delete a model component by using the **Delete** key or context menu option in the **Model Builder** app or by calling the `delete` function at the command line.

At the command line, if you have a variable referencing a model component that you have deleted, after undoing the deletion, you need to do an additional step to retrieve the model component using dot indexing, `get`, or `sbioselect`. This step lets you continue using the variable to update the properties of the model component.

To illustrate this point, consider a model *m1* open in the **Model Builder** app and exported to the MATLAB workspace. You have a variable *s1* referencing a model species and you use *s1* to change the species properties, such as its value.

```
s1 = sbioselect(m1, 'Type', 'species', 'Name', 's1');  
s1.Value = 10;  
delete(s1);
```

After the `delete` call, *s1* is displayed as a handle to the deleted species.

```
>> s1  
  
s1 =  
  
    handle to deleted Species
```

Next, you click **Undo** in the **Model Builder** app. The species shows up again in the app. However, at the command line, *s1* still displays as a handle to the deleted species. You cannot use *s1* to change the species properties as before. To retrieve the species, you need to use `get`, dot indexing, or `sbioselect`.

```
% Retrieve the species using dot indexing  
s1 = m1.Species(1);  
% Or retrieve using sbioselect  
s1 = sbioselect(m1, 'Type', 'species', 'Name', 's1');  
% Continue using the variable to change the object properties  
s1.Units = 'microgram/milliliter';
```

Note If you delete the *n*th model component in the model and undo the deletion, the model component is restored as the *n*th component.

Actions Not Supported for Undoing or Redoing

You cannot undo or redo the following actions.

- Removal of a model from a project. You can manually add the model back by importing it from the MATLAB workspace into the app, but you cannot undo or redo changes prior to the removal of the model from the project.
- Deletion of a model.
- Configurations for unit, unit prefix, and abstract kinetic law.
- App-specific configurations, such as **Preferences**.
- Diagram configurations not specific to the model, such as zoom level or panning.

See Also

`simbio.diagram.getBlock` | `simbio.diagram.setBlock` | `simbio.diagram.getLine` | `simbio.diagram.setLine` | `simbio.diagram.splitBlock` | `simbio.diagram.joinBlock` | `sbioselect` | `delete` | `Configset` | `Variant object` | `ScheduleDose object` | `RepeatDose object` | **SimBiology Model Builder** | **SimBiology Model Analyzer** | `Model` | `removedose (model)` | `removevariant (model)`

Generate SimBiology Model Report

You can generate a customizable report that summarizes various details of a SimBiology model, such as a model diagram, quantities and their corresponding values, model equations and expressions, doses, and variants.

On the **Home** tab of the **SimBiology Model Builder** app, select **Export** > Generate Model Report.

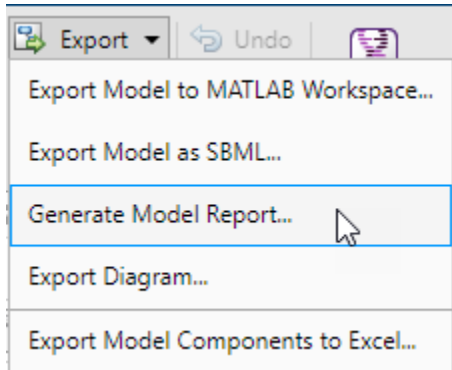

Next, in the **SimBiology Model Export** dialog, you can customize which model information to include in the report. Click **OK** and the app generates an HTML file as a report.

To export just the model diagram, select **Export** > Export Diagram. You can select the file format and image size.

The app saves the customization options you chose in the project so that they are available across MATLAB sessions for the same model. To configure the default settings of the dialog, go to **Preferences** > **Report Generation**.

See Also

[SimBiology Model Builder](#) | [SimBiology Model Analyzer](#)

More About

- “Generate Report for SimBiology Program Results” on page 1-122

Generate Report for SimBiology Program Results

For analysis results generated by each program in the **SimBiology Model Analyzer**, you can generate a customizable report that contains the program setups, results, plots, and information about the model and data used by the program.

To include the information about the model and data used by a program in the report, you need to save such information prior to running a program. Select the corresponding save option in the **Model** and **Data** sections of the program as shown next. These options also ensure that the report reflects the model and data at the time the results were generated and that any subsequent modifications to the model or data are not included in the report.

Tip Saving the model and data information increases the size of the project. You can check what information have been saved by opening the **Project** tab, which shows a summary of saved models and data and lets you remove them. For details, see “Check Saved Models and Data of Project” on page 1-123.

MODEL

MODEL

 TMDD

Prepare the model for accelerated simulation

Save the model with the program results. This must be checked for reports to include the model information.

DATA

DATA

 Program1.LastRun.results

Save the data with the program results. This must be checked for reports to include the data information.

After a program run, in the **Browser** pane, right-click the **LastRun** folder (or any other saved folder). Select **Generate Report**.

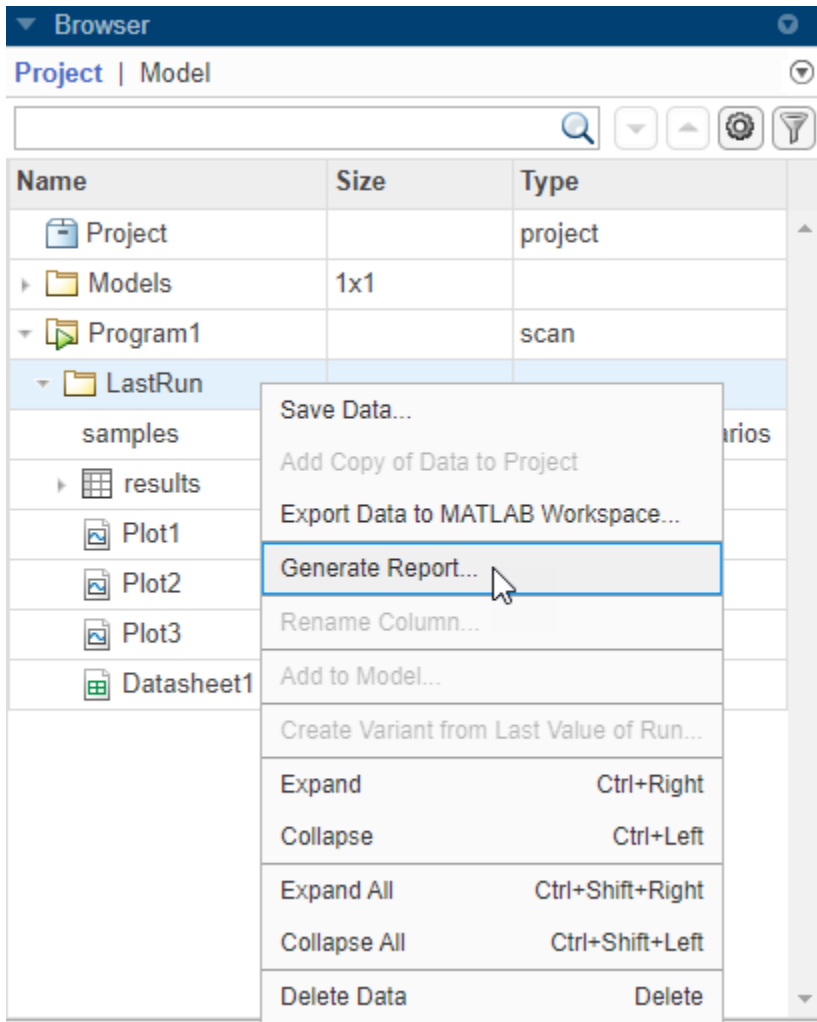

Next, in the **Generate Report** dialog, you can customize which information to include in the report. Click **OK** and the app generates an HTML file as a report. The app saves the customization options you chose in the project so that they are available across MATLAB sessions for the same program result. To configure the default settings of the dialog, go to **Preferences > Report Generation**.

Check Saved Models and Data of Project

The **Project** tab has a summary of saved models, data, and the corresponding size information for each program. To open the tab, do one of the following depending on whether your Browser is in the Project view (default) or Workspace view.

- In the **Browser**, under the **Project** tab, double-click the blue **Project** folder to open the **Project** tab with the detailed information.

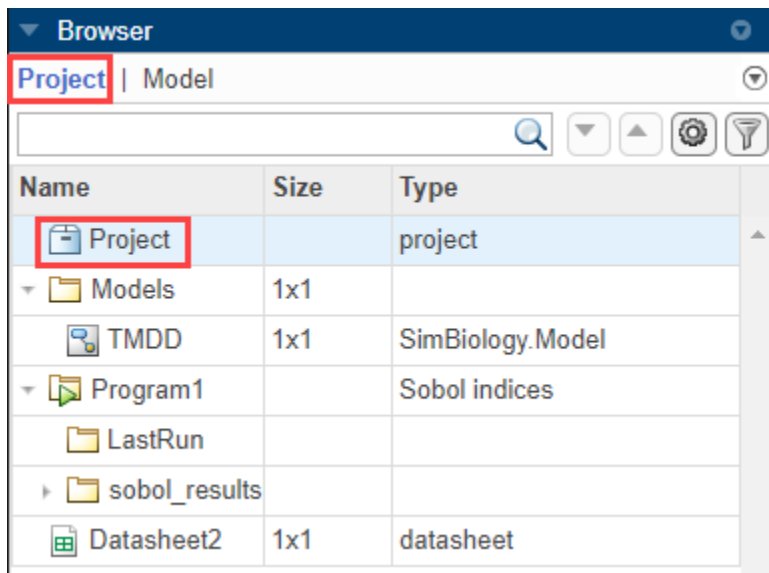

- In the **Browser**, under the **Documents** tab, double-click the blue **Project** folder.

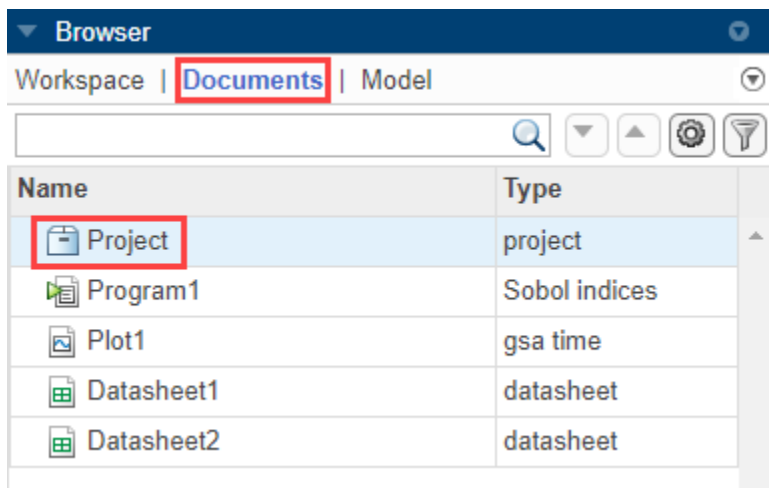

The **Project** tab provides a summary of project content, corresponding sizes, and tables of saved model and data. To remove any of the saved models or data, right-click the corresponding row under **Cached Models** or **Cached Data** and select **Delete**. Once you delete, the app will not be able to include the corresponding model or data information in future reports.

Project x
⌵

PROJECT

DESCRIPTION
Click to edit the description

LAST SAVED
23-Jun-2021 19:04:36

FILE CONTENT

Models, Data and Documents 🔄

	Name	Type	Size
1	All Models	SimBiology.Model	100 KB
2	Program1	Program	5 KB
3	Program2	Program	10 KB
4	Imported Data	Data	20 KB
5	Program2.fit_constant	Program Results	200 KB
6	Program2.LastRun	Program Results	400 KB
7	Program1.LastRun	Program Results	7 KB
8	Plots	Plots	10 KB
9	Datasheets	Datasheets	8 KB

Cached Models

	Type	Program Results	Size
1	Cached Model	Program2.LastRun	8 KB

Cached Data

	Type	Program Results	Size
1	☐ Cached Data	Program1.LastRun	2 KB
		Program2.LastRun	

Export Model to Workspace...

Expand Ctrl+Right

Collapse Ctrl+Left

Expand All Ctrl+Shift+Right

Collapse All Ctrl+Shift+Left

Delete 🖱️

See Also

SimBiology Model Builder | SimBiology Model Analyzer

More About

- “Generate SimBiology Model Report” on page 1-121

Percentile Plot







In the **SimBiology Model Analyzer** app, you can visualize time course data and its corresponding statistics using a percentile plot. The plot shows the percentile curves over time for an array of time courses along with other data statistics such as mean, standard deviation, minimum, and maximum values.

To show a percentile plot, select a data source that contains time courses in the **Browser** pane, then click **percentile** in the **Plot** section on the **Home** tab. For a workflow example, see “Visualize Simulation Statistics and Overlay Experimental Data Using Percentile Plot” on page 1-100.

Display Options

Each response in a percentile plot has three display options, which you can configure.

- **Percentiles** — Shows the percentile curves. By default, the plot shows 5th and 95th percentiles. Scan programs with more than 40 samples use percentile plots as default plots. You can change this default cutoff in **Preferences > Programs > Plots**. This is the default display type for simulation data.
- **Mean** — Shows the mean and standard deviation of response data at each time point. This is the default display type for experimental data.
- **Raw Data** — Shows the original response data points at each time point.

RESPONSES - Color		Color	Name	Display	Create Set
<input type="checkbox"/>	<input type="checkbox"/>		Program2:simdata1.Central.Drug (milligram/liter)	Percentiles	
<input type="checkbox"/>	<input type="checkbox"/>		Program2:simdata1.Peripheral.Drug (milligram/liter)	Percentiles	
<input checked="" type="checkbox"/>	<input type="checkbox"/>		Program2:simdata1.[Tumor Growth Model].tumor_weight (gram)	Percentiles	
<input type="checkbox"/>	<input type="checkbox"/>		Data1.CentralConc (milligram/liter)	Mean	
<input type="checkbox"/>	<input type="checkbox"/>		Data1.PeripheralConc (milligram/liter)	Percentiles	
<input checked="" type="checkbox"/>	<input type="checkbox"/>		Data1.TumorWeight (gram)	Mean	
				Raw Data	

Percentile Options

The **Percentiles** section provides the following options to configure the percentile curves.

Option	Description
Show percentiles (%)	Percentiles to plot. Enter one or more nonnegative numbers between 0 and 100 or any MATLAB expression that results in a nonnegative number or vector of values between 0 and 100 in ascending order.

Option	Description
Show median	Logical flag to show or hide the median line in the plot.
Show raw data fraction (%)	Percentage of time courses to show in the plot. Enter a nonnegative integer between 0 and 100.
Time vector	<p>Common time vector to which all time courses are interpolated before calculating the percentiles.</p> <p>The default <code>auto</code> option calculates a common time vector with time points that are evenly spaced between the minimum and maximum times from data.</p> <p>Enter a vector of nonnegative numbers or MATLAB expression that results in a vector of nonnegative numbers that are in ascending order.</p>
Interpolation method	Method used to interpolate time courses onto a common time vector. The app calls <code>interp1</code> with the specified “method”. For simulation data, the app treats multiple response values at the same time point as a discontinuity and performs piecewise interpolation between such time points. For experimental data, the app treats these response values at the same time point as repeated measurements and uses the mean of all measurements at the same time point.
Display style	Display format to show lines, shading, or both.

For details on how the app computes the percentile curves and other statistics, see “Calculation of Percentile Curves, Mean, and Other Statistics” on page 1-128.

Mean Options

The **Mean** section provides the following options to configure the plots.

Option	Description
Show mean	Logical flag to show the mean response value at each time point. The plot uses the marker <code>o</code> to represent mean values.
Show standard deviation	Logical flag to show ± 1 standard deviation of the response value at each time point. The plot shows error bars to indicate the standard deviations.

Option	Description
Show min/max	<p>Logical flag to show the derived minimum and maximum response values at each time point.</p> <p>To calculate these values, the app first interpolates all the time courses to a common time vector and then computes the statistics, such as min, max, mean, and standard deviation, at each time point on the common time vector across all interpolated time courses. Hence the interpolated maximum and minimum values at a given time point shown in the percentile plot may not match those values of the raw data exactly.</p> <p>The plot uses the marker * to indicate the minimum and maximum values.</p>
Show raw data fraction (%)	Percentage of time courses to show in the plot. Enter a nonnegative integer between 0 and 100.
Time vector	<p>Common time vector to which all time courses are interpolated before calculating the minimum, maximum, and mean values.</p> <p>The default <code>auto</code> option calculates a common time vector with time points that are evenly spaced between the minimum and maximum times from data.</p> <p>Enter a vector of nonnegative numbers or MATLAB expression that results in a vector of nonnegative numbers that are in ascending order.</p>
Interpolation method	Method used to interpolate time courses onto a common time vector. The app calls <code>interp1</code> with the specified “method”. For simulation data, the app treats multiple response values at the same time point as a discontinuity and performs piecewise interpolation between such time points. For experimental data, the app treats these response values at the same time point as repeated measurements and uses the mean of all measurements at the same time point.
Display style	Display format to show lines, markers, or both.

For details on how the app computes the mean, minimum, maximum response values, and other statistics, see “Calculation of Percentile Curves, Mean, and Other Statistics” on page 1-128.

Calculation of Percentile Curves, Mean, and Other Statistics

The app computes the percentile curves, mean, minimum, maximum response values, and other statistics using the following steps.

- 1 The app obtains a common time vector by using the code specified in the **Time vector** option or by automatically computing it as a linearly spaced vector of times between the minimum and maximum times across all the groups (or runs) in the input data source.
- 2 It then interpolates the response time course for each group or run onto the common time vector using `interp1` with the method specified in the **Interpolation method** option. For simulation data, the app treats multiple response values at the same time point as a discontinuity and

performs piecewise interpolation between such time points. For experimental data, the app treats data at the same time point as repeated measurements and uses the mean of all measurements at those time points.

- 3 The app then calculates the corresponding statistics, such as percentiles, mean, max, standard deviation, for each time point in the common time vector across all groups for that time point in the interpolated time courses.

Note Because of interpolation, calculated maximum and minimum values might be different than those values from the original data.

- 4 It then generates a plot using the calculated statistics against the common time vector according to the **Display style** option.

See Also

SimBiology Model Analyzer

Related Examples

- “Calculate NCA Parameters and Fit Model to PK/PD Data Using SimBiology Model Analyzer App” on page 1-77

View and Run Program Code Generated by SimBiology Model Analyzer

You can generate MATLAB code for analysis programs in **SimBiology Model Analyzer** and run the code at the command line. The following example shows how to generate code for a simulation program, export the necessary inputs for the program to the MATLAB workspace, and run the code.

Open Bioavailability Project

The `Bioavailability.sbproj` file contains a simulation program that you can open directly in the **Model Analyzer** app. For details about the model, see “Estimating the Bioavailability of a Drug” on page 4-78.

At the MATLAB command line, enter:

```
simBiologyModelAnalyzer("Bioavailability.sbproj");
```

Generate Code for Simulation Program

- 1 In the **Browser** panel, double-click **Simulation** to open the simulation program. Note that your panel can look slightly different than the screen shot below if you are in the Workspace view of the browser.

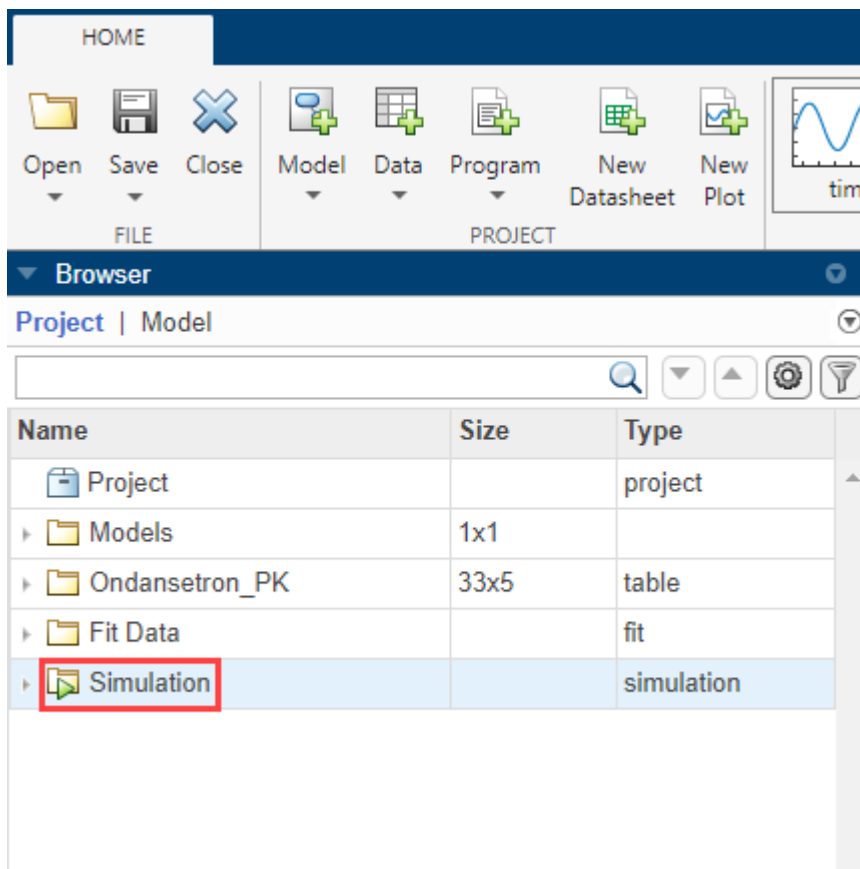

The program shows the details about the simulation, such as the model, the dose being used, and simulation stop time.

- 2 In the **Browser** panel, right-click **Simulation** and select View Program Code.

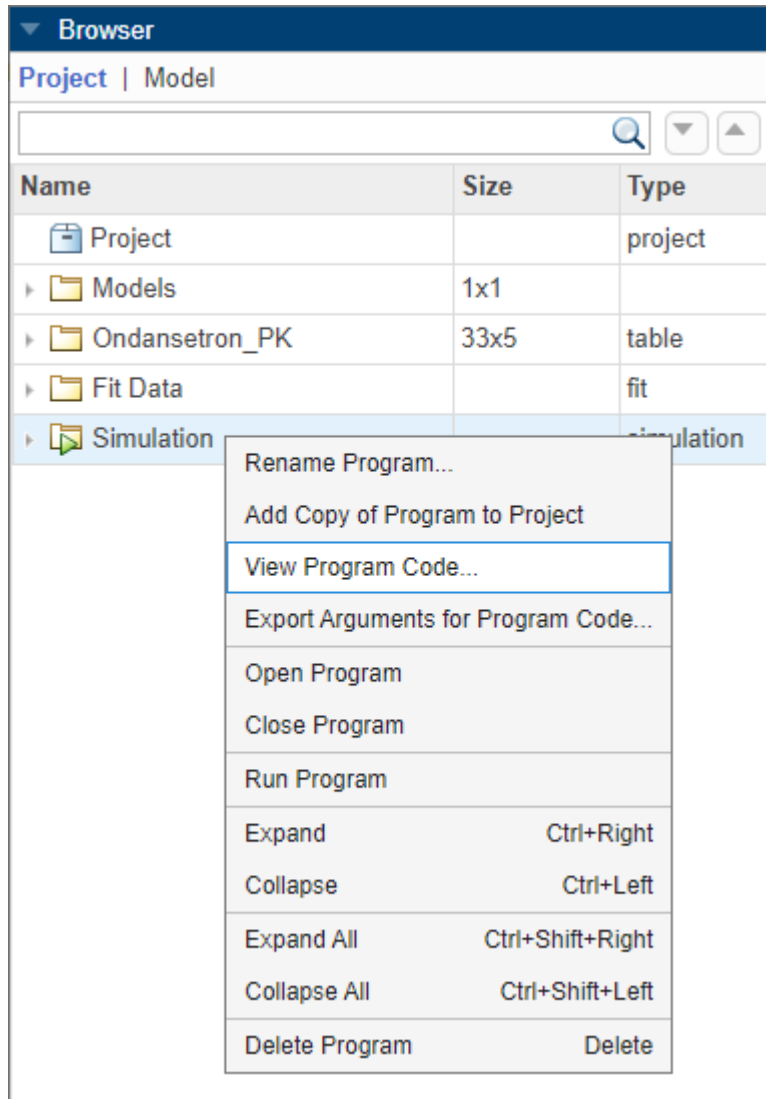

- 3 It opens an untitled MATLAB function file containing the code for the program. Save the file to a local directory in your computer using the default file name (runprogram.m).

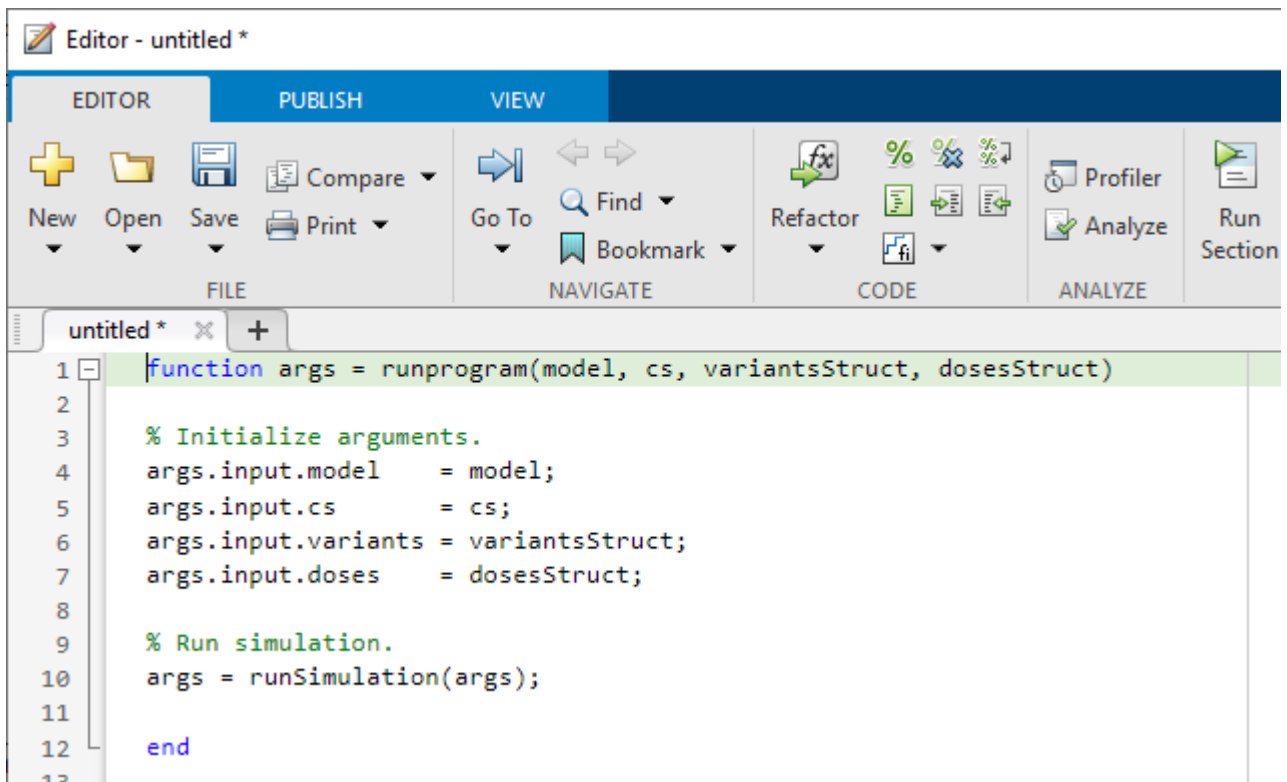

Export Input Arguments

Before you can run the generated code, you need to export the input arguments needed for the program code to your MATLAB workspace.

In the **Browser** panel, right-click **Simulation** and select **Export Arguments for Program Code...**



Use the variable name `args` for the program arguments.

Run Program Code and Plot Results

- 1 In the MATLAB workspace, go to the directory where you saved `runprogram.m`. One way is to right-click the file name in the MATLAB Editor and select **Change Current Folder to...**

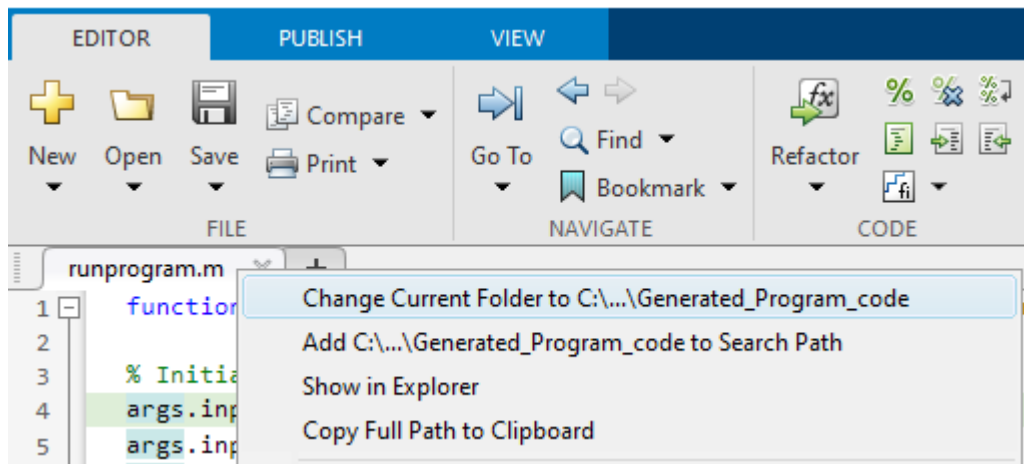

- 2 Run the generated code.

```
programResults = runprogram(args{:})  
programResults =  
    struct with fields:  
        input: [1x1 struct]  
        output: [1x1 struct]
```

The returned output `programResults` is a structure with two fields: `input` and `output`. The `input` contains a structure with the fields — `model`, `cs` (simulation settings), `variants`, and `doses` — that were used to run the program. The `output` contains a structure with the simulation results.

- 3 Plot the simulation results.

```
sbiplot(programResults.output.results)
```

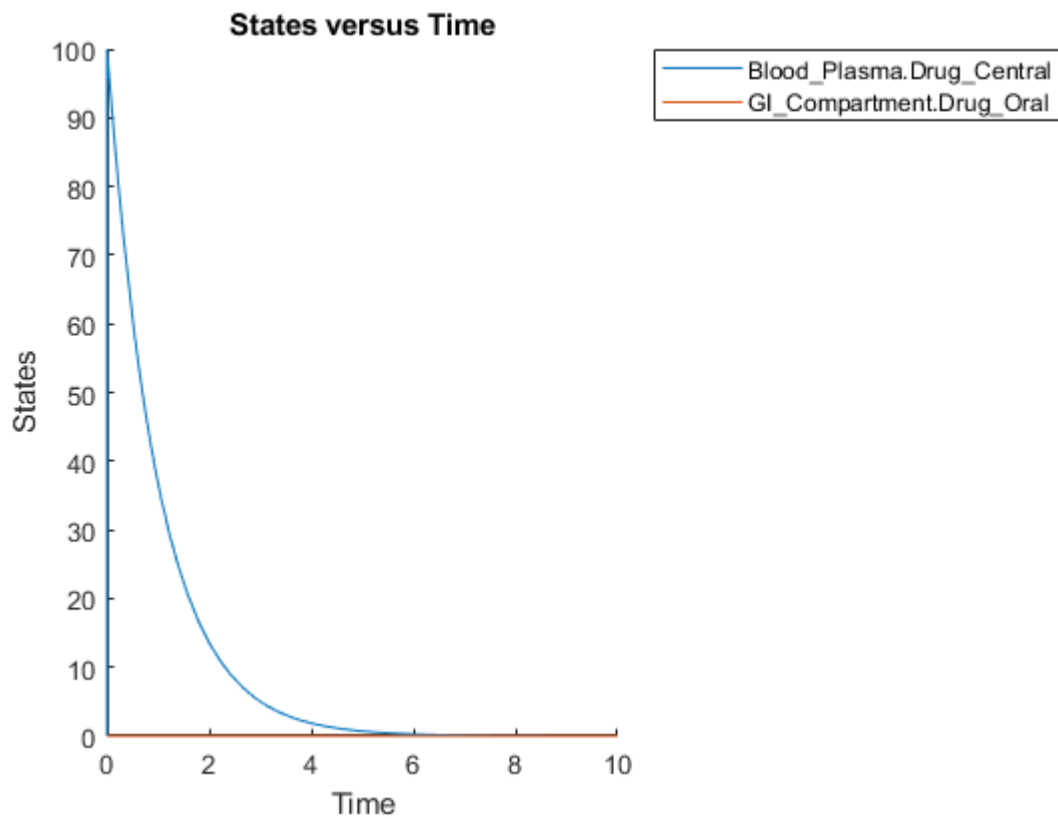

See Also
SimBiology Model Analyzer

Related Examples

- “Estimating the Bioavailability of a Drug” on page 4-78

Simulate Groups Using Doses and Variants from Data Set

The **Group Simulation** program in the **SimBiology Model Analyzer** app lets you simulate various groups, such as patients, from your data set on page 5-5. If the data set also has dosing information and group-specific variants, the program lets you apply them to each group during simulation. It also lets you reuse the same program setup and perform parameter estimation. The following steps illustrate how to simulate the tumor weight of various patients and reuse the same program configuration to estimate some model parameters.

Load Tumor Growth Model and Data

- 1 At the MATLAB command line, enter:

```
simBiologyModelAnalyzer("tumor_growth_fitPKPD.sbproj");
```

For details about the model, see “Tumor Growth Model” on page 1-77.

- 2 In the **Browser** pane (if it is in the default **Project View**), expand the **Data1** folder and double-click **Datasheet1** to open the data set.

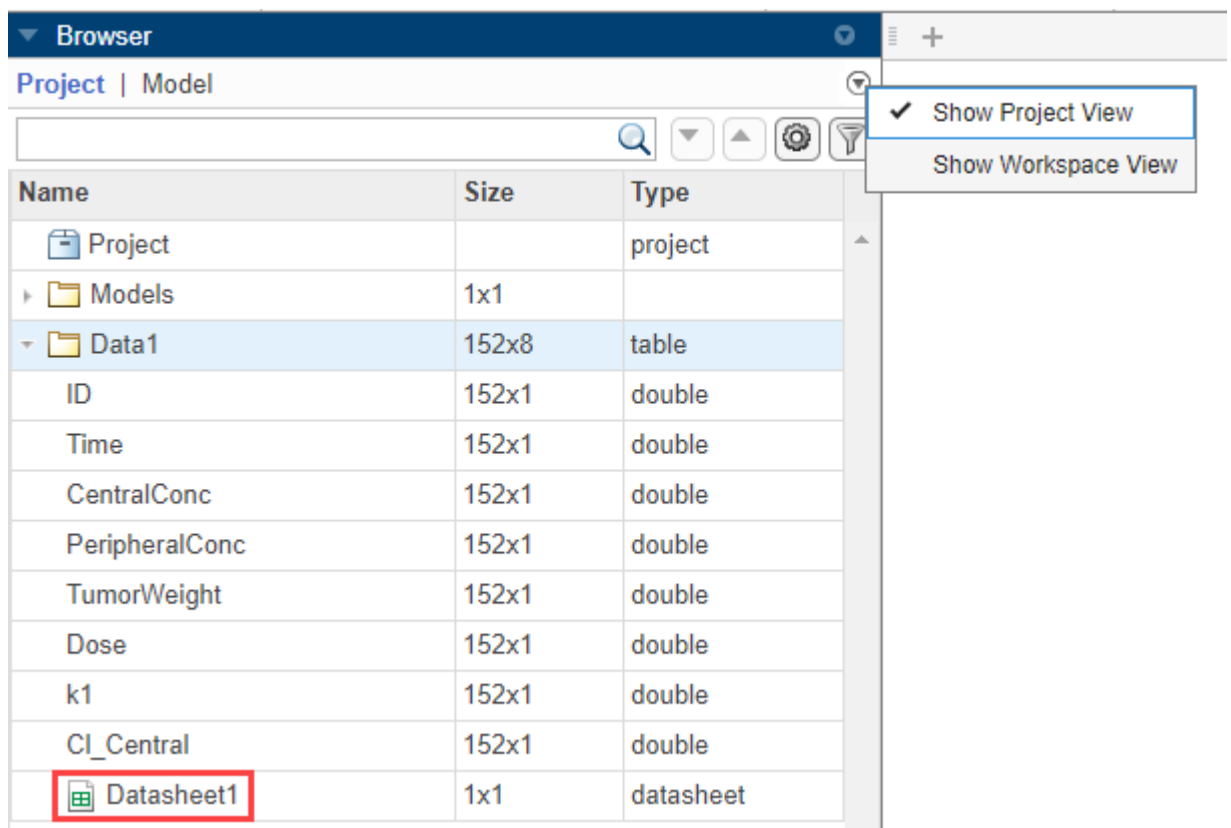

If your browser is in the **Workspace View**, click **Documents** and double-click **Datasheet1** instead.

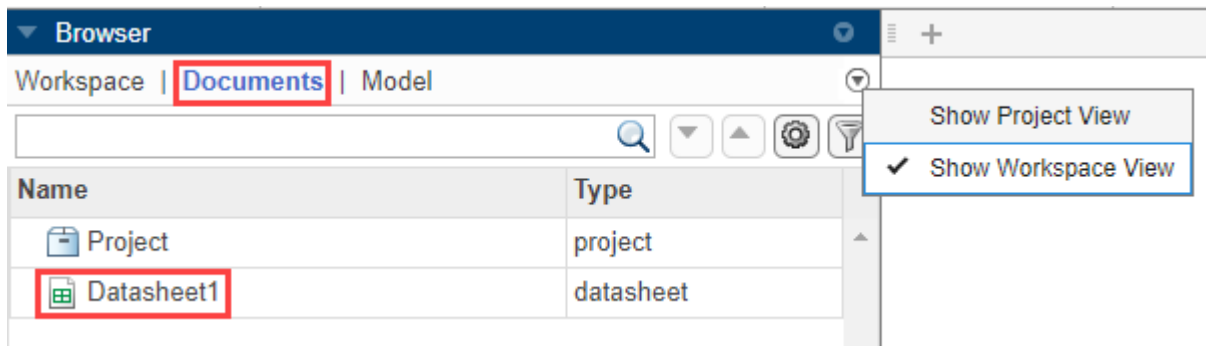

For some of the columns, the app automatically classifies them as follows:

- The *ID* column as **group** (a grouping variable).
 - The *Time* column as **independent** (an independent variable).
 - The *Dose* column as **dose1** (a dosing variable). If the data has more than one dose columns, you can classify them as **dose2**, **dose3**, and so on.
- 3 For the measured response data columns such as *CentralConc*, you need to manually classify them as the dependent variables. Double-click **Classification** under *CentralConc*. Select **dependent**. Repeat the same process for *PeripheralConc* and *TumorWeight*.

Tip The data set also contains two variant columns *k1* and *Cl_Central*, which contain group-specific values for the parameters *k1* and *Cl_Central*. Optionally, you can classify them as **covariate**.

ID	Time	CentralConc	PeripheralConc	TumorWeight	Dose	k1	Cl_Central
1	0	NaN	NaN	0.9810	NaN	0.4780	0.7370
2	1	NaN	NaN	1.0120	NaN	NaN	NaN
3	3	NaN	NaN	1.5840	NaN	NaN	NaN
4	5	NaN	NaN	1.7820	NaN	NaN	NaN
5	6	NaN	NaN	3.2260	NaN	NaN	NaN
6	7	13.5510	NaN	3.1500	30	NaN	NaN
7	7.2500	1.9650	0.6970	3.0860	NaN	NaN	NaN
8	7.5000	0.2840	0.7680	2.8690	NaN	NaN	NaN
9	7.7500	0.0680	0.4010	2.9910	NaN	NaN	NaN
10	8	0.0370	0.2980	2.2770	NaN	NaN	NaN
11	9	0.0070	0.0690	2.5190	NaN	NaN	NaN
12	10	0.0020	0.0170	2.5060	NaN	NaN	NaN

Simulate Groups Using Doses and Variants from Data Set

The following steps show you how to set up the program for simulation.

Map Response, Dose, and Variant Data to Model Components

- 1 Select **Program > Group Simulation** to open a group simulation program. The **Model** and **Data** steps of the program have been prepopulated with **Tumor Growth Model** and **Data1**, respectively.

- In the **Data Map** table, clear **CentralConc** and **PeripheralConc**. Keep **TumorWeight** selected.
- Double-click the **Component** cell next to **TumorWeight** and enter tumor. Select [Tumor Growth Model].tumor_weight from the drop down menu.

DATA MAP

Use	Classification	Value
	group	ID
	independent	Time
<input type="checkbox"/>	⊕ response	CentralConc ~ COMPONENT
<input type="checkbox"/>	⊕ response	PeripheralConc ~ COMPONENT
<input checked="" type="checkbox"/>	⊖ response	TumorWeight ~ tumor
	Column	= [Tumor Growth Model]
	Component	= [Tumor Growth Model].tumor_weight
<input checked="" type="checkbox"/>	⊕ dose from data	Dose -> [Tumor Growth Model].x1
		[Tumor Growth Model].x2
		[Tumor Growth Model].x3
		[Tumor Growth Model].x4

Add to Map: Response Dose Variant

VARIANT AND DOSE SETUP

- Apply the doses from the data set. In the **dose from data** row, map the *Dose* column to *Central.Drug* to indicate that the *Drug* species in the *Central* compartment is being dosed.

<input checked="" type="checkbox"/>	⊕ dose from data	Dose	-> Drug
-------------------------------------	------------------	------	---------

Add to Map: Response Dose Variant

Central.Drug

Peripheral.Drug

- To apply group-specific variants from the data set, click the variant button (Variant). A **variant from data** row appears. Double-click the cell named **Column** and enter the name of the variant column from the data set to use: *k1*. In the next cell, enter the corresponding component name, which is also *k1*.



<input checked="" type="checkbox"/>	⊖ variant from data	k1	~ k1
	Column	= k1	
	Component	= k1	
	Unit Conversion	= auto	

- Similarly, map the *Cl_Central* column.

<input checked="" type="checkbox"/>	⊖ variant from data	Cl_Central	~ Cl_Central
	Column	= Cl_Central	
	Component	= Cl_Central	
	Unit Conversion	= auto	

- 7 The **Variant and Dose Setup** table is automatically updated to indicate that the variants and doses from the data are now being applied to the model.

VARIANT AND DOSE SETUP					
VARIANT AND DOSE SETUP					
Group Name	Variants1	Variants2	Variants3	Doses1	Doses2
	Group Specific	Data	Data	Group Specific	Data
1	1	k1	Cl_Central		Dose
2	2	k1	Cl_Central		Dose
3	3	k1	Cl_Central		Dose
4	4	k1	Cl_Central		Dose
5	5	k1	Cl_Central		Dose
6	6	k1	Cl_Central		Dose
7	7	k1	Cl_Central		Dose
8	8	k1	Cl_Central		Dose

Add Group Specific Column:  Dose  Variant *Variants are applied from right to left.*

Run Simulation Step

In the **Simulation** step, you can select whether to include the time points from the data set only, include solver time points only, or include both during model simulation. You must select one option.

- **Time points contain data times within each group** — Include the exact time points for each group from data, such as the times listed in the *Time* column of the input data set.
- **Time points contain solver time points** — Include time points used by the solver during model simulation. This option lets you define a custom stop time or pick a maximum stop time from data.
 - **Simulate to maximum time within each group** — Use the group-specific maximum time. Each group simulates to its own stop time.
 - **Simulate to maximum time across all groups** — Use a single stop time across all the groups. The app checks all the stop times from the groups and picks the maximum.
 - **Stop Time** — Use a custom stop time.

Note If the last time point of a group from the data set is greater than the specified stop time, the program ignores the stop time and simulates until that last time point for that group.

You can also add sliders to vary model quantity values in the **Explorer** panel, and the **Slider Summary** section displays each of those quantities. For now, leave it empty. See “Perform Group Simulation Using Parameter Estimates” on page 1-142 for more information on sliders.

To check other simulation settings, such as solver type and absolute tolerance, point the mouse to the top right and click the option menu button. For the purposes of this example, use the default simulation options that are already selected as shown in the following figure.

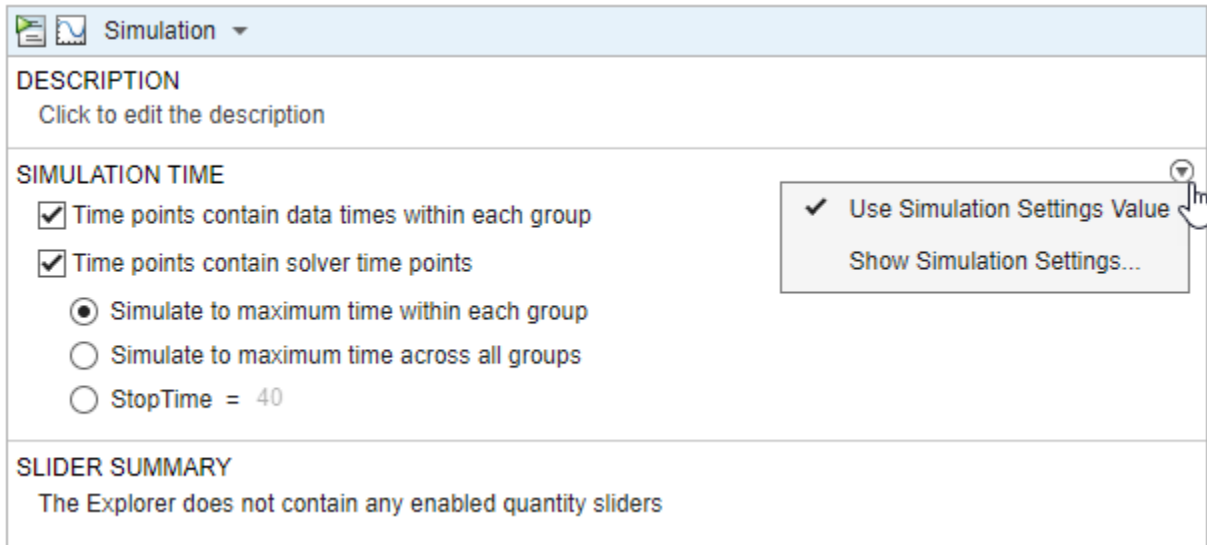

- 1 Click the Run button of the step to simulate the groups.

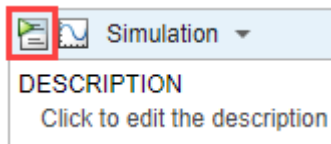

- 2 The program opens the **Plot1** tab to show the simulated tumor weight response for each group as shown next. The solid lines are the simulation results while the dotted lines with circle markers represent the experimental data.

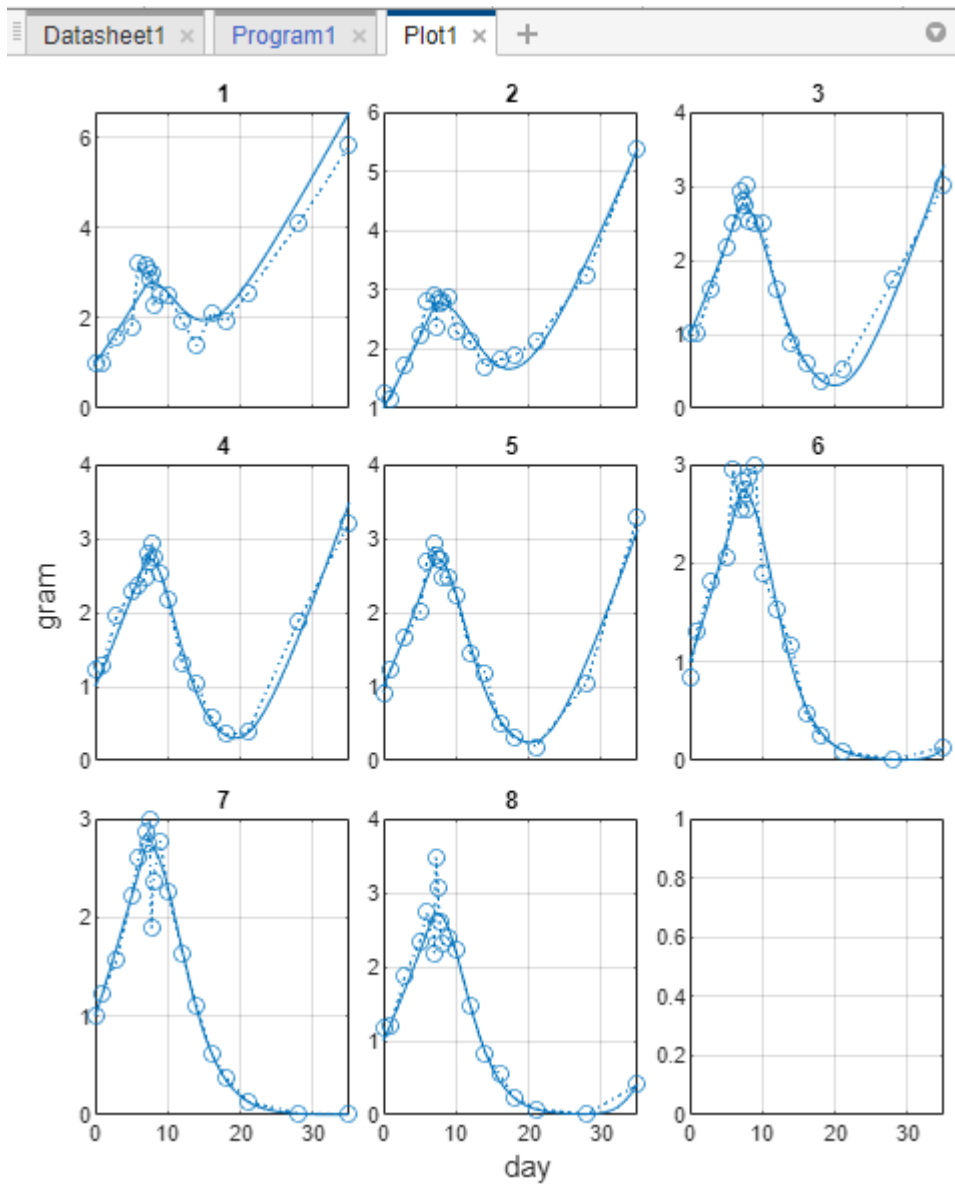

Estimate Parameters Using Same Setup as Group Simulation

The program lets you fit model parameters to data using the same setup you use for group simulation without having to reconfigure or create a separate **Fit Data** program.

- 1 At the top of the **Simulation** step, select Simulation > Fit.

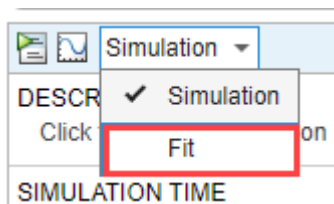

- Click **Yes** if a dialog asks whether to continue. The step changes to the **Fit** step.

Tip Switching steps here removes the results of the step that you just ran. To avoid the results from being removed, you can save the results first before switching. In the **Browser** panel, expand **Program1**. Right-click **LastRun** and select **Save Data**.

- In the **Estimated Parameters** table, double-click the empty row and enter $L0$. Similarly, enter $L1$ as shown in the following figure.

ESTIMATED PARAMETERS		
Use	Estimated Parameters	Transformation
<input checked="" type="checkbox"/>	<input type="checkbox"/> L0	= log
	Initial Untransformed Value	= 0.4000
	Untransformed Lower Bound	=
	Untransformed Upper Bound	=
<input checked="" type="checkbox"/>	<input type="checkbox"/> L1	= log
	Initial Untransformed Value	= 0.3000
	Untransformed Lower Bound	=
	Untransformed Upper Bound	=

- At the bottom of the table, select **Pooled Fit** to estimate one set of parameter values for all groups.

Pooled fit

Leave the rest of the settings as default. Note that the default estimation method is `lsqnonlin` if you have Optimization Toolbox. If you do not, the app uses `fminsearch`.

ERROR MODEL	
Use the same error model for each response	: constant
ESTIMATION METHOD	
<input type="checkbox"/> Use a global solver	
<input checked="" type="radio"/> lsqnonlin	<input type="radio"/> fminunc
<input type="radio"/> fminsearch	<input type="radio"/> lsqcurvefit
<input type="radio"/> fmincon	
ALGORITHM SETTINGS ⓘ	
Click to view options	
ADVANCED ALGORITHM SETTINGS	
Click to view advanced options	

- Click the Run button of the **Fit** step to estimate parameters.

- The program next opens several tabs for the fit results and plots. For example, **Datasheet2** contains the pooled parameter estimates and other fit statistics, such as AIC. For a more detailed fitting workflow example, see “Calculate NCA Parameters and Fit Model to PK/PD Data Using SimBiology Model Analyzer App” on page 1-77.

Perform Group Simulation Using Parameter Estimates

You can switch back to the simulation step and simulate the groups using the pooled parameter estimates without applying the group-specific variants this time.

- At the top of the **Fit** step, select **Fit > Simulation**. Click Yes if a dialog shows up to confirm. The step changes to **Simulation**.

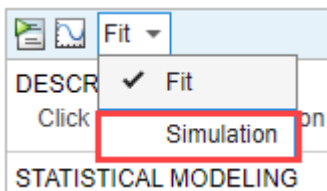

- In the **Slider Summary** section of the step, point the mouse to the top right, click the option menu button, and select **Update Sliders to Match Fit Estimates**.

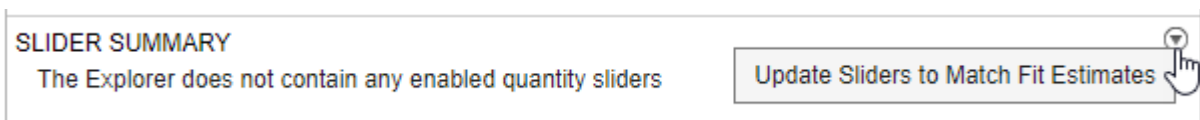

The table now lists *L0* and *L1* parameters. The **Value** column contains the estimated values transferred from the previous **Fit** step.

Type	Component Name	Lower Bound	Upper Bound	Value
parameter	L0	0.3383	0.5074	0.4229
parameter	L1	0.2303	0.3455	0.2879

- Expand the **Explorer** panel. It now contains sliders for *L0* and *L1*. The current value for each parameter is displayed on the top right of the slider bar as shown next.

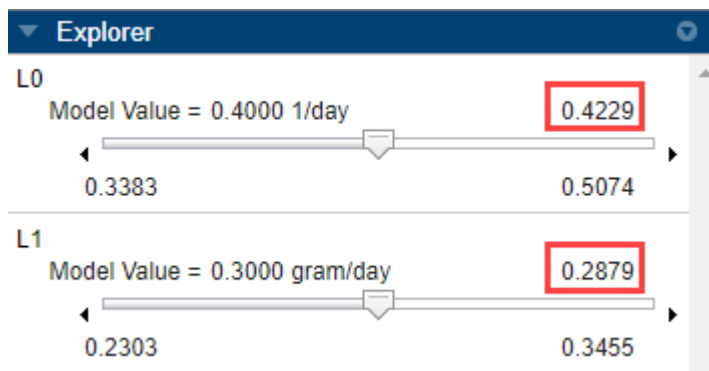

- 4 In the **Data Map** table, clear the variant rows for *k1* and *Cl_Central*.

DATA MAP

Use	Classification	Value
<input checked="" type="checkbox"/>	response	TumorWeight ~ [Tumor Growth Model].tumor_weight Column = TumorWeight Component = [Tumor Growth Model].tumor_weight
<input checked="" type="checkbox"/>	dose from data	Dose -> Central.Drug Bolus Dose
<input type="checkbox"/>	variant from data	k1 ~ k1 Column = k1 Component = k1 Unit Conversion = auto
<input type="checkbox"/>	variant from data	Cl_Central ~ Cl_Central Column = Cl_Central Component = Cl_Central Unit Conversion = auto

- 5 Run the Simulation step. The program simulates the groups using the parameter estimates without applying group-specific variants and opens **Plot1**.

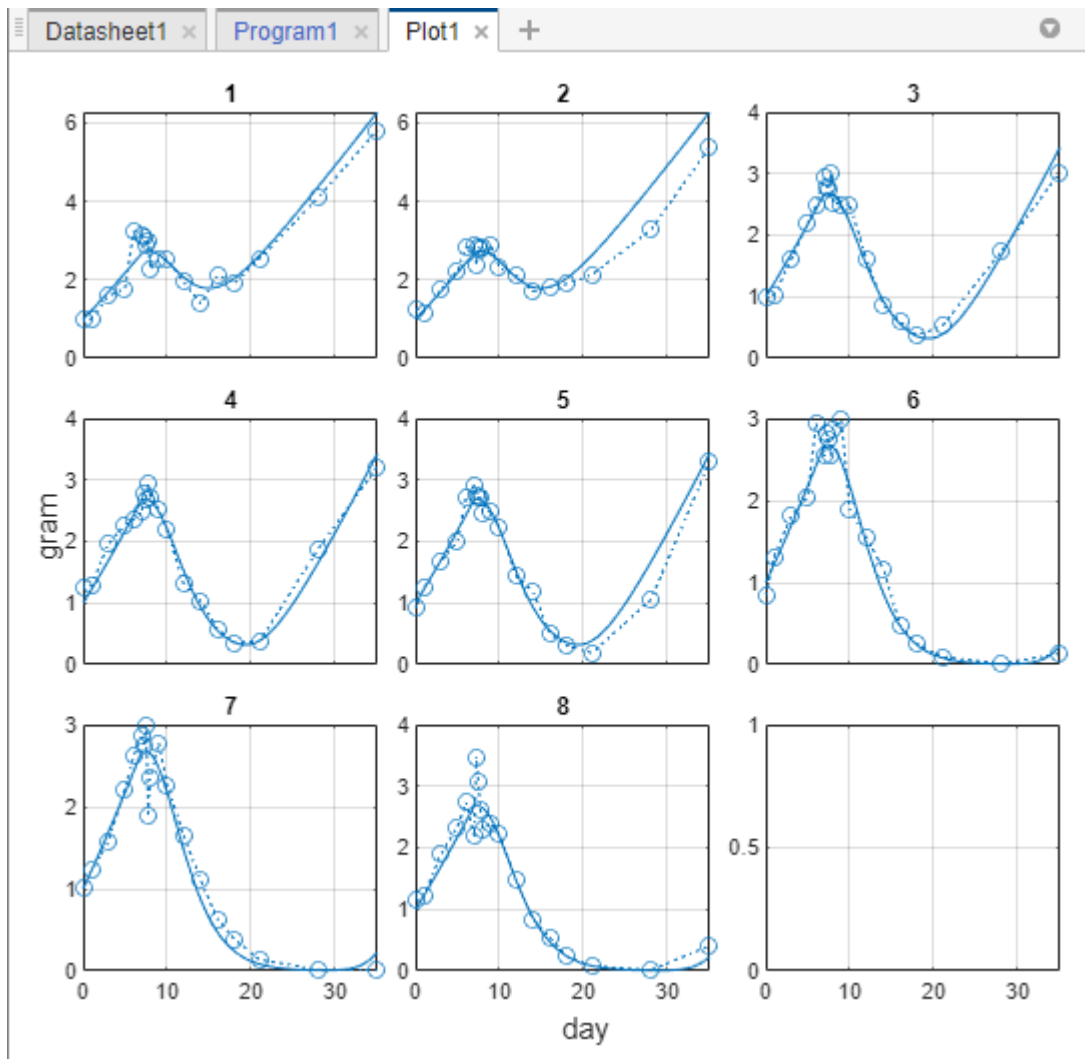

- 6 You can also explore the model behavior by moving the sliders in the **Explorer** panel to different parameter values or applying just some of the group-specific variants or doses.

Tip Each time you move a slider, the program automatically simulates by default. You can change this default behavior by going to **Preferences > Programs > Run program when slider changes value**. Set the value to `false`. Then the program reruns only when you hit the Run button.

See Also

SimBiology Model Analyzer

More About

- “Create Data File with SimBiology Definitions” on page 5-5
- “Calculate NCA Parameters and Fit Model to PK/PD Data Using SimBiology Model Analyzer App” on page 1-77

- “Find Important Parameters with Local Sensitivity Analysis Using SimBiology Model Analyzer App” on page 1-41
- “Model Biological Variability with Virtual Patients Using SimBiology Model Analyzer App” on page 1-61
- “Scan Dosing Regimens Using SimBiology Model Analyzer App” on page 1-108

Find Important Parameters with Global Sensitivity Analysis Using SimBiology Model Analyzer

This example shows how to identify important parameters in a target-mediated drug disposition (TMDD) on page 1-108 model using the **Global Sensitivity Analysis** (GSA) program in **SimBiology Model Analyzer**. In this example, you compute Sobol indices and elementary effects, and also perform multiparametric GSA (MPGSA) to find model parameters that the target or receptor occupancy (TO) is sensitive to. For more information on supported sensitivity analysis features, see “Sensitivity Analysis in SimBiology” on page 4-19.

The GSA program requires Statistics and Machine Learning Toolbox.

Load TMDD Model

At the MATLAB command line, enter:

```
simBiologyModelAnalyzer("tmdd_with_T0.sbproj")
```

The app opens, and the **TMDD** model is loaded in the **Models** folder of the **Browser** panel.

Perform Parameter Scan to Assess Model Behavior

Before performing the global sensitivity analysis on the model, run a parameter scan to get a general idea of how the model response (TO) behaves with respect to parameters of interest. For this example, scan the following model parameters: km , $kdeg$, and kon .

- 1 Select **Program** > Run Scan.
- 2 Go to the **Generate Samples** step of the program. Disable auto plot generation by clicking the plot icon.

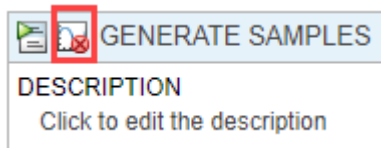

- 3 In the **Parameter Set** table, double-click the empty cell in the **Component Name** column. Enter km . Change **Type**, **Spacing**, **Min**, **Max**, and **# Of Steps** options as shown next.

Use	Component Name	Current Value
<input checked="" type="checkbox"/>	km	0.0458
	Type = Range Of Values	
	Spacing = linear	
	Min = 1.0000e-3	
	Max = 0.1000	
	# Of Steps = 5	

- 4 Set up *kdeg* and *kon* similarly to *km*, except use 0.5 as the **Max** value.

Use	Component Name	Current Value
<input checked="" type="checkbox"/>	kdeg Type = Range Of Values Spacing = linear Min = 1.0000e-3 Max = 0.5000 # Of Steps = 5	0.0934
<input checked="" type="checkbox"/>	kon Type = Range Of Values Spacing = linear Min = 1.0000e-3 Max = 0.5000 # Of Steps = 5	0.0485

- 5 Change **Parameter Combination** to cartesian. For details about the combination methods, see “Combine Simulation Scenarios in SimBiology” on page 3-23.

GENERATE SAMPLES

DESCRIPTION
Click to edit the description

PARAMETER SET : Quantity

Name = PS1
Type = user defined values
Parameter Combination = elementwise (5)

Use	Component Name	Current Value
<input checked="" type="checkbox"/>	kdeg Type = Range Of Values Spacing = linear Min = 1.0000e-3 Max = 0.5000 # Of Steps = 5	0.0934
<input checked="" type="checkbox"/>	kon Type = Range Of Values	0.0485

cartesian
elementwise

- 6 Click **Simulation Settings** on the **Home** tab of the app.

- In the **Simulation Time** section, change **StopTime** to 2.
- In the **States To Log** section, click **Clear All**. Then select **TO** only.

Click **Close**.

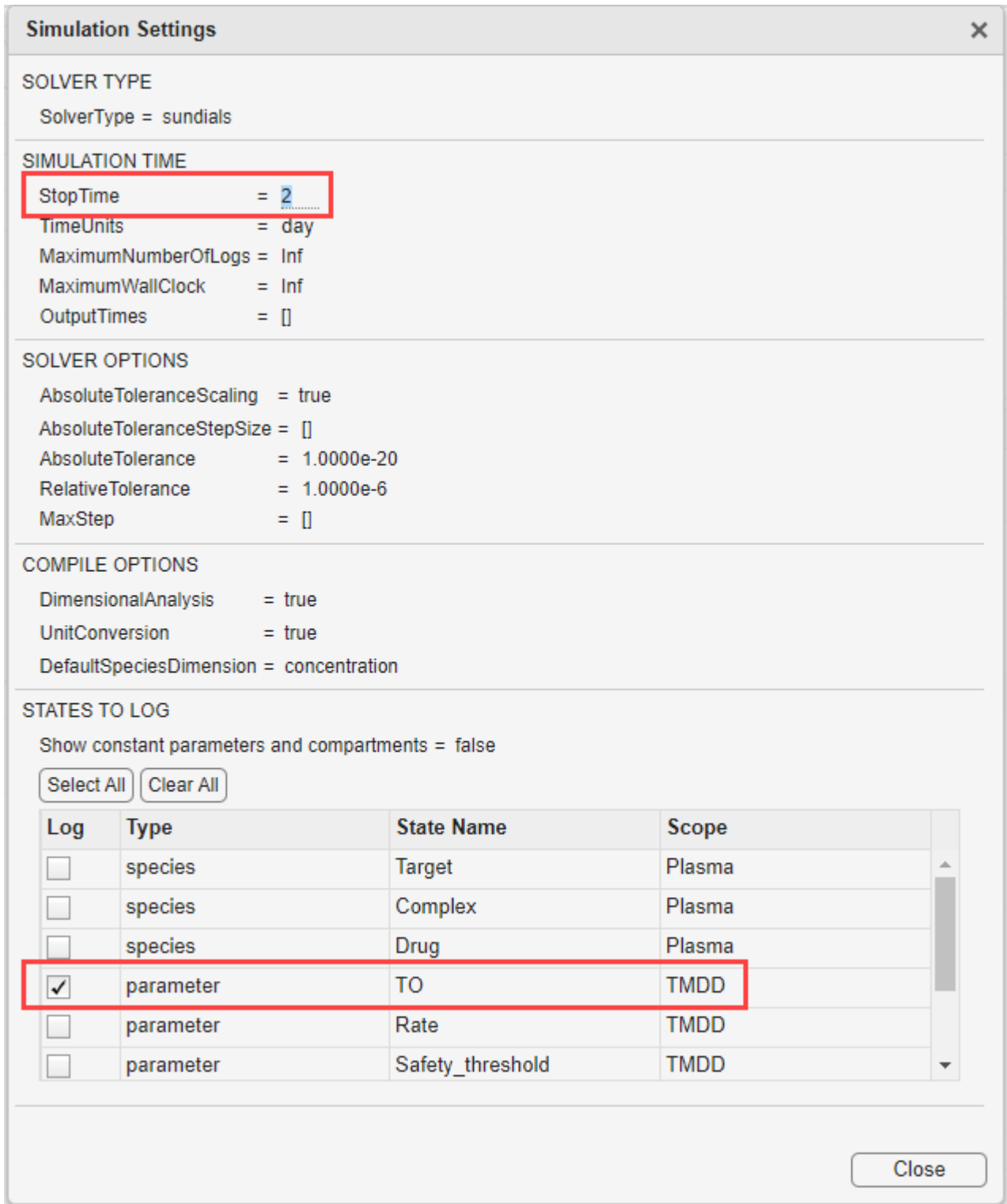

7 Click **Run** on the **Home** tab.

- 8 The program then opens the **Plot1** tab. Click **Time** in the **Property Editor** pane on the right to see the time courses of the model response (TO) with respect to different parameter combinations of km , $kdeg$, and kon .

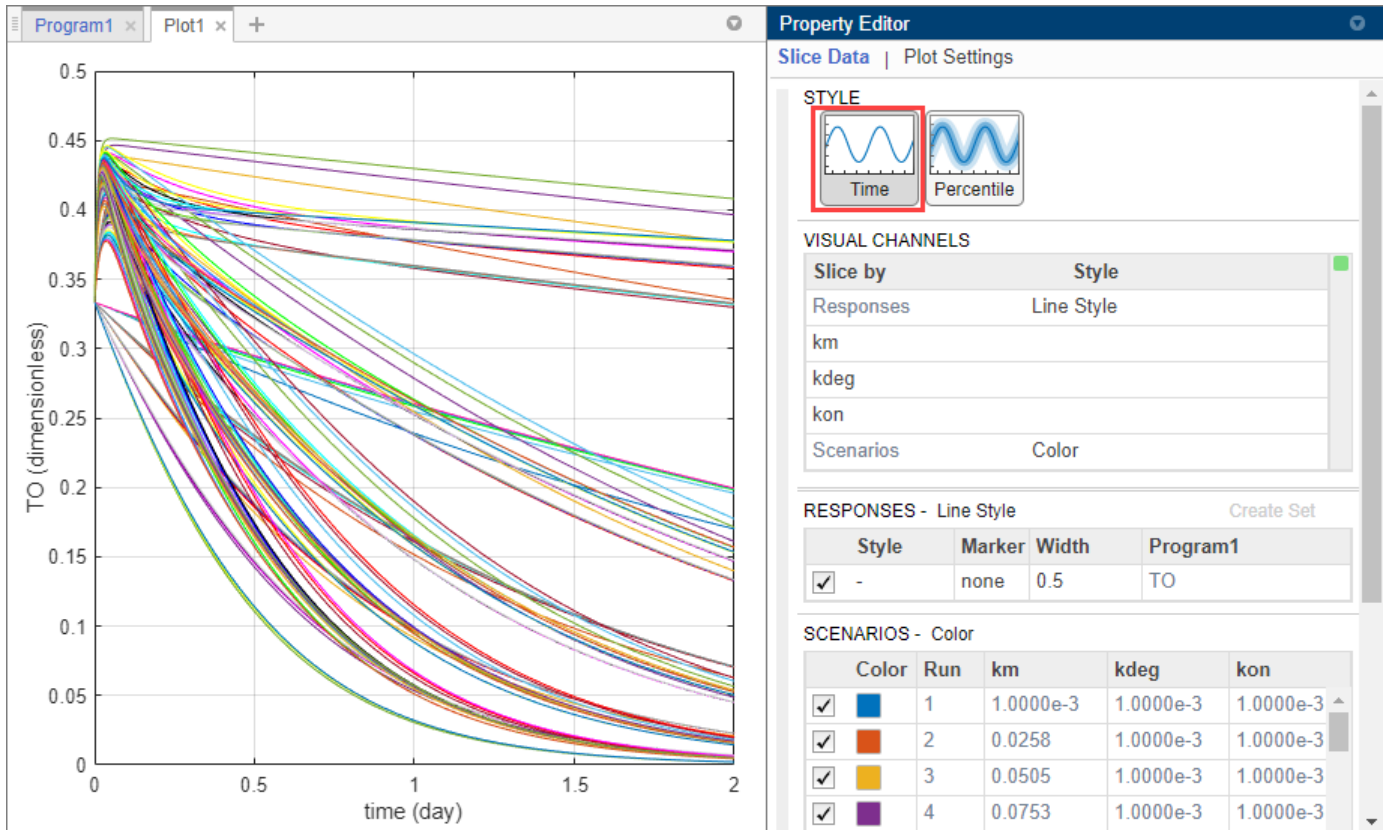

- 9 Categorize the plot to make it easier to identify the sources of sensitivity. In the **Property Editor** pane, under **Visual Channels**, change the style of km , $kdeg$, and kon as in the following figure. You need to also change the style of **Scenarios** from Color to empty.

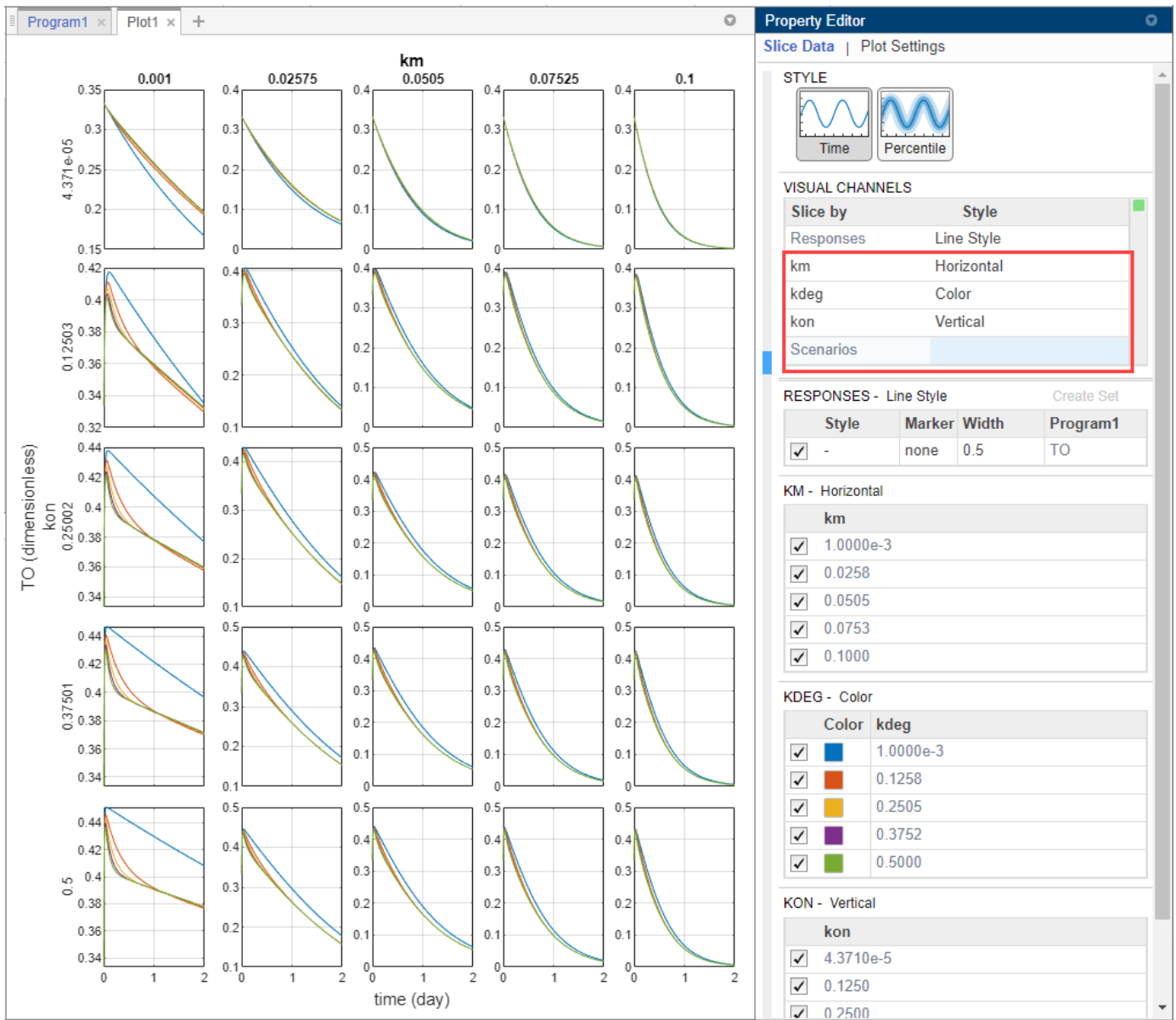

- 10** Click **Plot Settings** and click **Link Y-Axis** to use the same Y-axis limit for all plots and to make the plots more comparable. The plot indicates that *TO* is sensitive to changes in *kon* and *km* values. It seems to be less sensitive to variations in *kdeg*. Optionally, you can also scan one parameter at a time by disabling and enabling the parameters in the **Parameter Set** table to see the effect of each parameter.

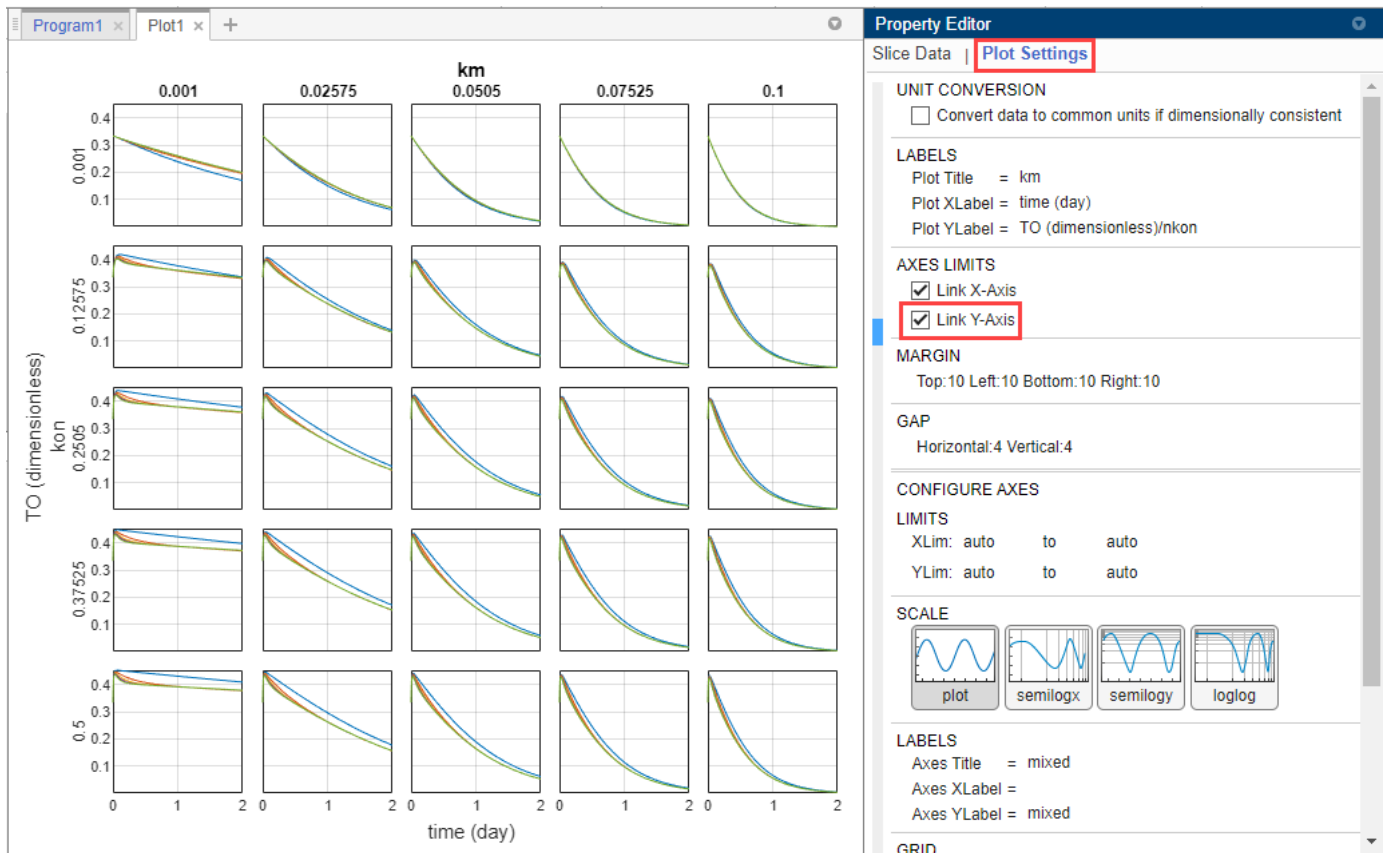

Follow the next steps to perform GSA on these parameters to get more insights into relative contributions of individual parameters that contribute most to the overall model behavior.

Compute Sobol Indices

The section shows you how to perform GSA by computing the first-order and total-order Sobol indices on page 4-19 of model parameters using the **Global Sensitivity Analysis** program.

- 1 Select **Program** > Global Sensitivity Analysis. By default, the program uses **Sobol indices** as a GSA analysis method.
- 2 Define the model parameters of interest in the **Sensitivity Inputs** table. Double-click the empty cell under **Component Name** column and enter km .
- 3 By default, the program uses the uniform distribution to sample parameter values. To see a list of supported distributions, click **Uniform**. For this example, use the uniform distribution and set the **Lower** and **Upper** bounds to $1e-3$ and 0.1 , respectively.

SENSITIVITY INPUTS

Name = Input1

Use	Component Name	Current Value
<input checked="" type="checkbox"/>	km	0.0458
	Distribution = Uniform	
	Lower = 1.0000e-3	
	Upper = 0.1000	

- 4 Similarly, set up *kdeg* and *kon* as sensitivity inputs. Use 0.5 as the **Upper** value.

<input checked="" type="checkbox"/>	kdeg	0.0934
	Distribution = Uniform	
	Lower = 1.0000e-3	
	Upper = 0.5000	
<input checked="" type="checkbox"/>	kon	0.0485
	Distribution = Uniform	
	Lower = 1.0000e-3	
	Upper = 0.5000	

- 5 In **Sampling Options**, use the default values.

SAMPLING OPTIONS

Type = sobol
 Skip = 1
 Leap = 0
 Point Order = standard
 Scramble Method = none

Sampling Types

SimBiology provides the following sampling methods.

Type	Description
sobol	Use the low-discrepancy Sobol sequence to generate samples. For details, see <code>sobolset</code> .
halton	Use the low-discrepancy Halton sequence to generate samples. For details, see <code>haltonset</code> .
latin hypercube	Use low-discrepancy Latin hypercube samples. If UseLhsDesign is also set to true, SimBiology uses <code>lhsdesign</code> . Otherwise, it uses a nonconfigurable Latin hypercube sampler that is different from <code>lhsdesign</code> .

Type	Description
random	Use randomly distributed samples.

- 6 In the **Sensitivity Outputs** table, enter *TO*.

SENSITIVITY OUTPUTS	
Use	Component Name
<input checked="" type="checkbox"/>	TO
<input type="checkbox"/>	

- 7 Click the Run button of the **Sobol Indices** step.

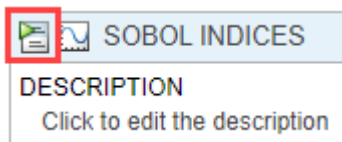

The status bar at the bottom of the program provides the run progress and the number of runs that have been finished.

Total Number of Runs

The total number of runs required is different depending on the number of sensitivity inputs, number of samples, and the GSA analysis method.

- For **Sobol Indices**, the total number of runs is: $(\text{number of sensitivity inputs} + 2) \times \text{number of samples}$.

- For **Elementary Effects**, the total number of runs is: (number of sensitivity inputs + 1) × number of samples.
 - For **MPGSA**, the total number of runs is equal to the number of samples.
- 8 The program opens the **Datasheet1** and **Plot2** tabs. By default, **Plot2** shows the **GSA Time** plot of the first-order and total-order Sobol indices for each input parameter.

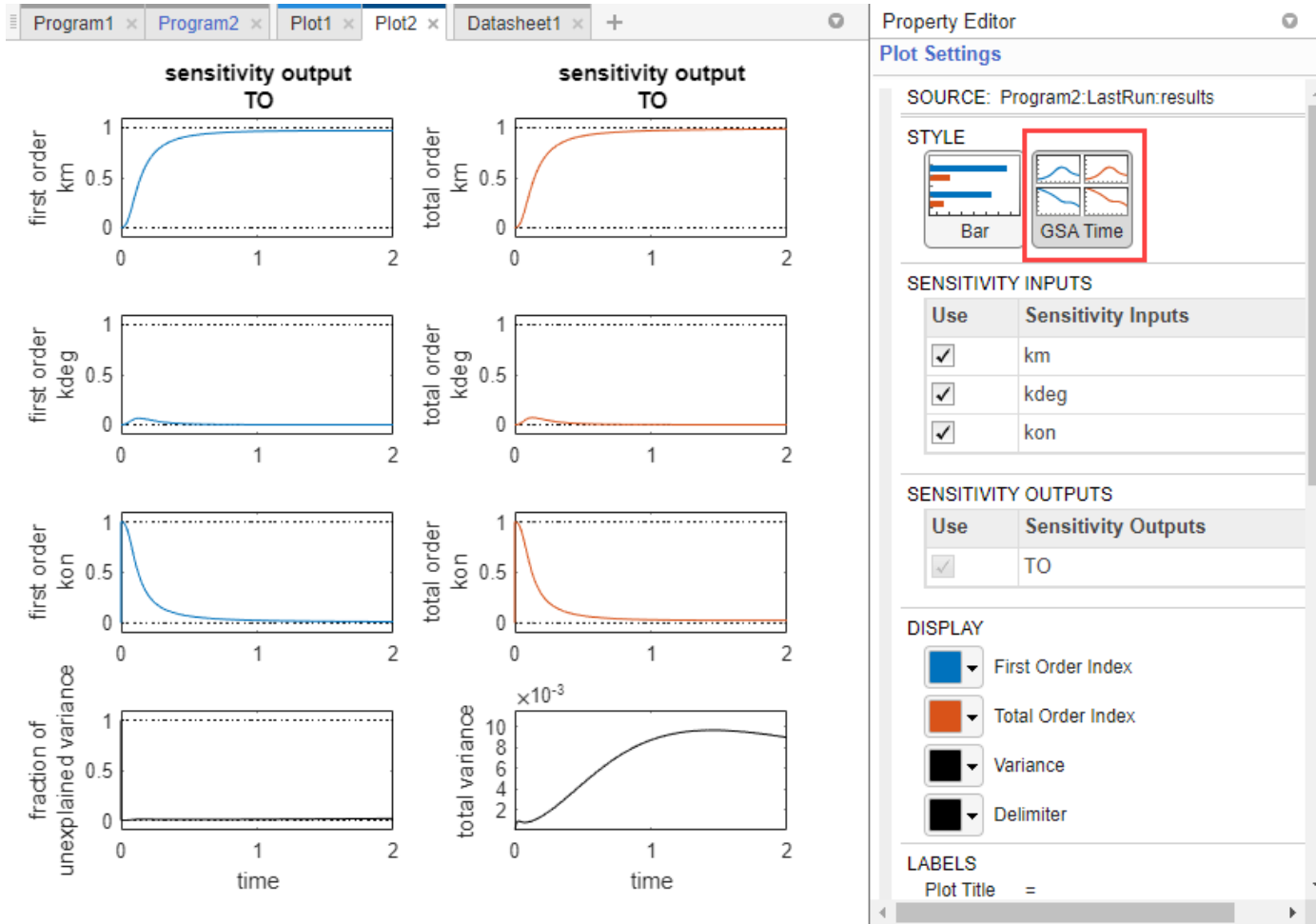

The first-order Sobol index of an input parameter gives the fraction of the overall response variance that can be attributed to variations in the input parameter alone. The total-order index gives the fraction of the overall response variance that can be attributed to any joint parameter variations that include variations of the input parameter. Based on the first-order and total-order plots, both *km* and *kon* seem to be the sensitive parameters to *TO*. *km* seems to become more sensitive at later time points while *kon* is more sensitive before time = 1. The fraction of unexplained variance plot is a flat line, which means that there is almost no unexplained variance and most variances are accounted for in the first-order and total-order plots.

Unexplained Variance and Total Variance

The fraction of unexplained variance is calculated as $1 - (\text{sum of all the first-order Sobol indices})$, and the total variance is calculated using $\text{var}(\text{response})$, where *response* is the model response at every time point.

Bar Plot

You can also see the bar plot of the Sobol indices by clicking **Bar** in **Plot Settings**. The color shading of each bar is a histogram representing values at different times. Darker colors mean that those values occur more often over the whole time course. This plot is especially useful to visualize the Sobol indices of scalar responses or observables.

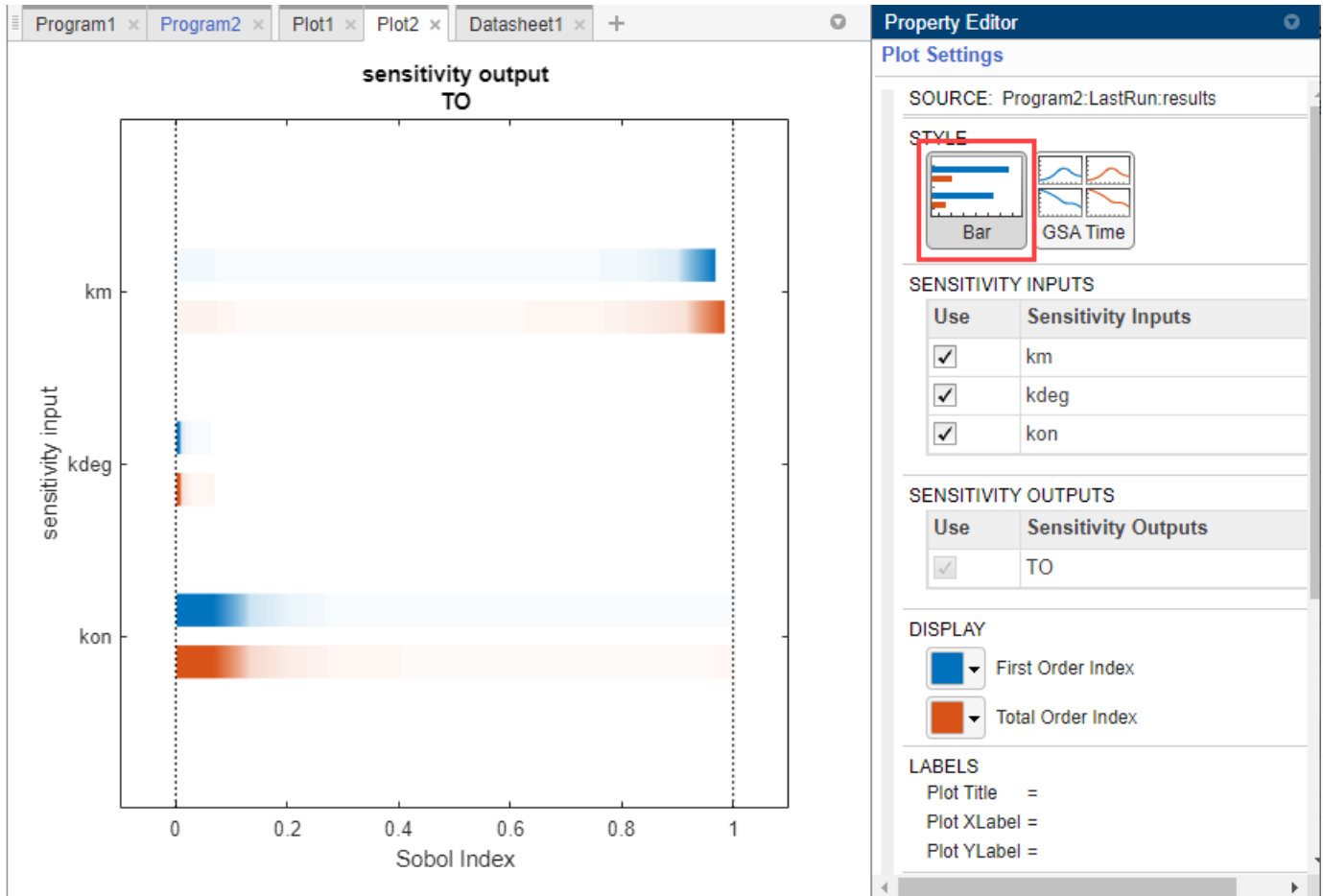

- Click the **Datasheet1** tab to view the tables of GSA program results. The first table shows the time dependent responses of Sobol indices. In the second table, you can find out if any model simulation failed during the computation by checking the **Number of Successful Samples** row. In this example, there were no failed simulations as all 1000 samples were successfully simulated.

Sobol Indices Time Dependent Responses (Program2: LastRun)					
	Time	Variance TO	[Input: km, Output: TO]		[Input: kdeg,
			First Order	Total Order	First Order
1	0	2.4171e-30	0	0	0
2	1.4862e-5	4.7726e-9	0.0011	0.0011	1.9751e-7
3	2.9724e-5	1.9035e-8	0.0011	0.0011	3.8138e-7
4	6.8170e-5	9.9610e-8	0.0011	0.0011	6.9351e-7
5	1.0662e-4	2.4226e-7	0.0011	0.0011	1.0757e-6
6	1.4506e-4	4.4571e-7	0.0011	0.0011	1.3046e-6
7	1.8351e-4	7.0812e-7	0.0011	0.0011	1.8672e-6
8	2.6799e-4	1.4909e-6	0.0011	0.0011	2.7819e-6
9	4.7574e-4	4.5527e-6	0.0012	0.0012	4.7932e-6
10	6.8348e-4	9.1029e-6	0.0012	0.0012	7.4638e-6
11	8.9123e-4	1.4996e-5	0.0012	0.0012	9.3409e-6
12	0.0011	2.2089e-5	0.0013	0.0013	1.1937e-5
13	0.0014	3.2254e-5	0.0013	0.0013	1.5198e-5
14	0.0016	4.3851e-5	0.0014	0.0014	1.8070e-5
15	0.0019	5.6688e-5	0.0014	0.0014	2.2002e-5
16	0.0023	8.0768e-5	0.0015	0.0015	2.9586e-5
17	0.0027	1.0719e-4	0.0016	0.0016	3.7575e-5
18	0.0032	1.3527e-4	0.0017	0.0017	4.5860e-5
19					

Sobol Indices Sample Information (Program2: LastRun)

	Property	Value
1	Number of Samples	1000
2	Number of Successful Samples	1000

Compute Elementary Effects

The following steps show you how to reuse the same program setup in the previous step to compute the means and standard deviations of the elementary effects on page 4-20 of input parameters with respect to the model response *TO*.

- Given that computing GSA results is often computationally expensive, save the previous Sobol indices results before switching over to elementary effects. In the **Browser** panel, expand **Program2**. Right-click **LastRun** and select **Save Data**. Enter the name of the data as `sobol_results`. Click **OK**.

Check Project Size

As you save more GSA results, the project size increases. To check the sizes of results from each program and other file contents, open the **Project** tab by double-clicking the **Project** icon in the **Browser**. For details, see “Check Saved Models and Data of Project” on page 1-123.

- Go back to the **Program2** tab. In the **Sobol Indices** step, under the **Analysis** section, select `Sobol indices > Elementary effects`.

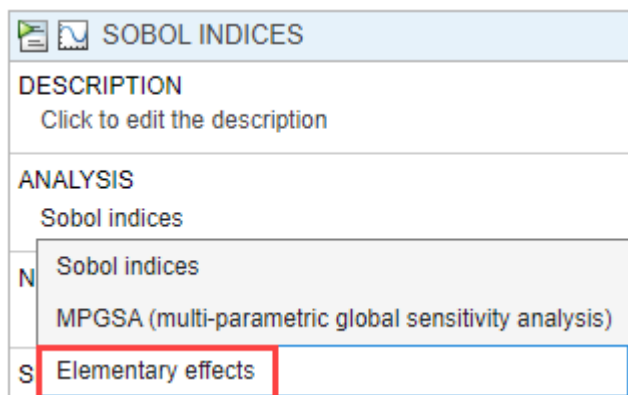

- The **Sensitivity Inputs** table is automatically set up with the same set of parameters and their corresponding upper and lower bounds as the previous step.
- TO* is the only sensitivity output.
- Use the default values for **Grid Settings**. Click the info icon to display additional information for each option. For details about how the algorithm uses these settings, see “Elementary Effects for Global Sensitivity Analysis”.

GRID SETTINGS 		
PointSelection	= chain	Method for selecting points used to compute elementary effects
SamplingMethod	= lhs	Method for generating parameter samples
GridLevel	= 10	Discretization of sensitivity inputs into GridLevel+1 equidistant points (must be an even integer)
GridDelta	= 5	Step size in grid cells to compute elementary effects

- Use the default value (`AbsoluteEffects = true`) for the **Output Settings** as well. The program uses the absolute elementary effects by default because the elementary effects can average out when you calculate the mean otherwise.
- Click the Run button of the **Elementary Effects** step.
- The program then opens the **Datasheet2** and **Plot3** tabs. By default, **Plot3** shows the **GSA Time** plot of the mean and standard deviation of elementary effects for each input parameter.

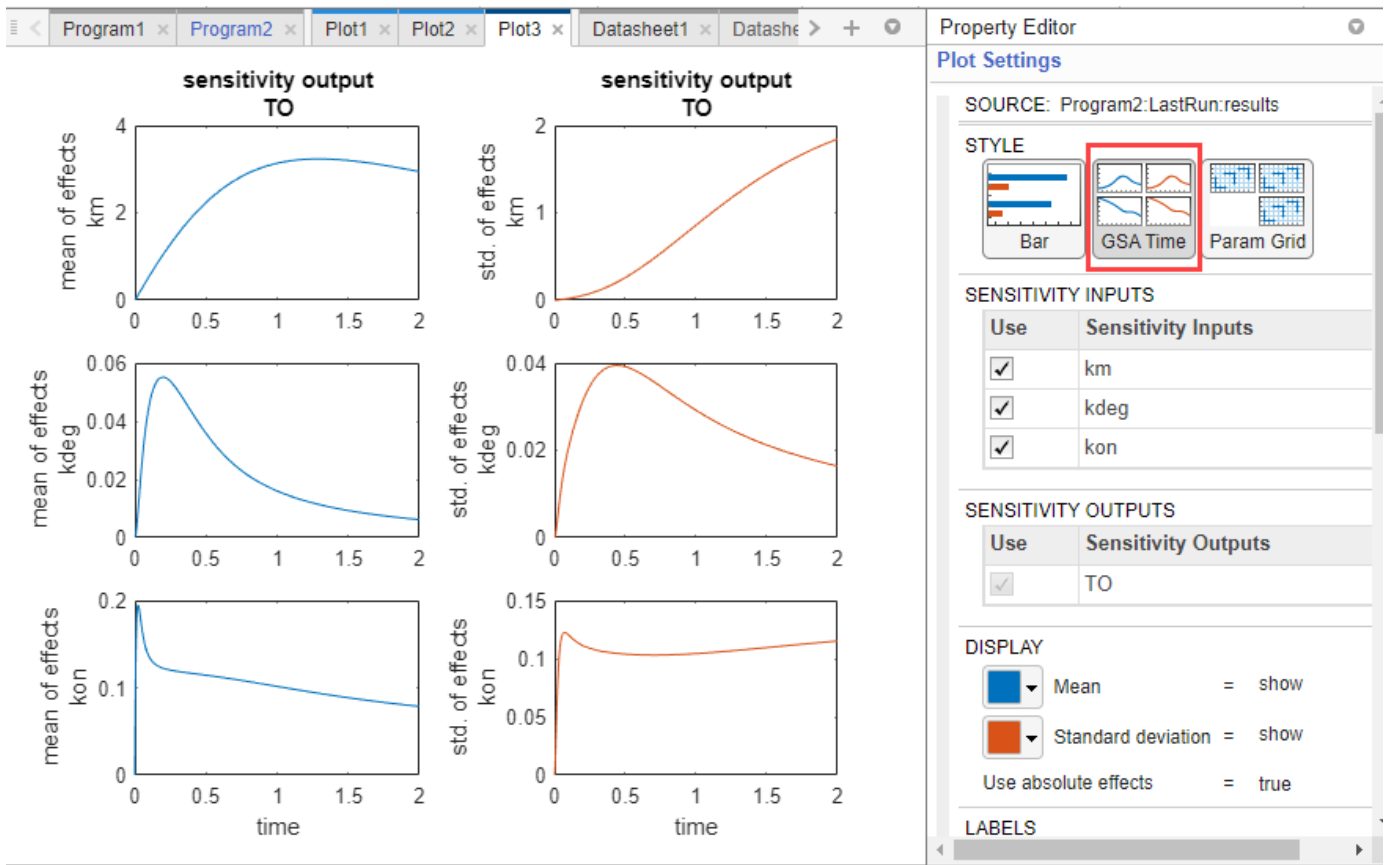

The mean of elementary effects explains whether variations in input parameter values have any effect on the model response TO . The mean plots indicate km becomes more sensitive at later time points and kon is more sensitive before time = 0.5. This trend is similar to the Sobol GSA results as well. $kdeg$ also shows some sensitivity but might be insignificant because mean values are much smaller than those of km and kon . The standard deviation of effects explains whether the sensitivity change is dependent on the location in the parameter domain. For instance, the km standard deviation plot indicates larger deviations for larger parameter values in the later stage (time > 0.5).

Param Grid Plot

Click **Param Grid** in **Plot Settings** to visualize the parameter grids and samples used to compute the elementary effects. The grid plot provides a visual of if there was a good coverage over the parameter domain. For this example, there was good coverage as shown in the following figure. For details on how the grid points are selected, see “Elementary Effects for Global Sensitivity Analysis”.

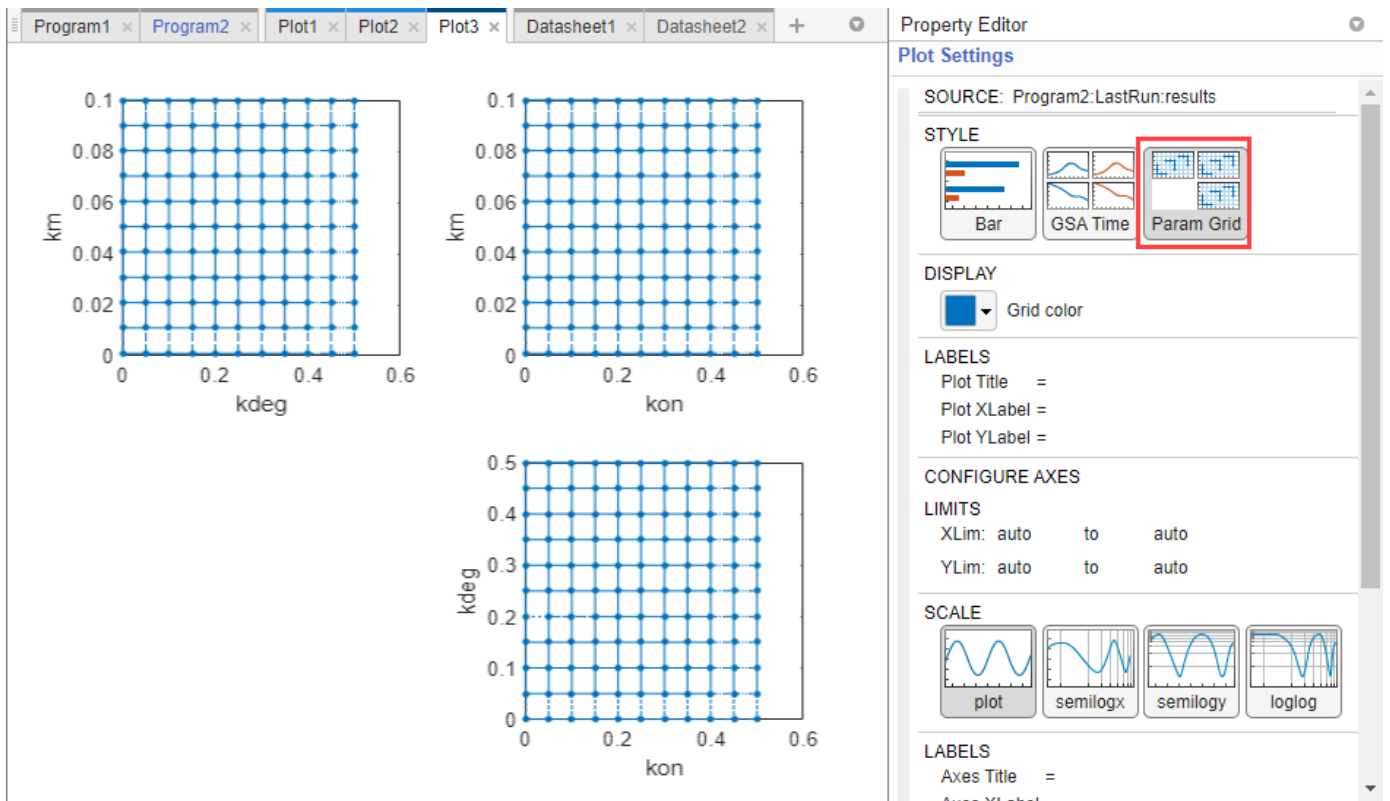

Bar Plot

You can also see the bar plot of the means and standard deviations of elementary effects by clicking **Bar** in **Plot Settings**. The color shading of each bar is a histogram representing values at different times. Darker colors mean that those values occur more often over the whole time course.

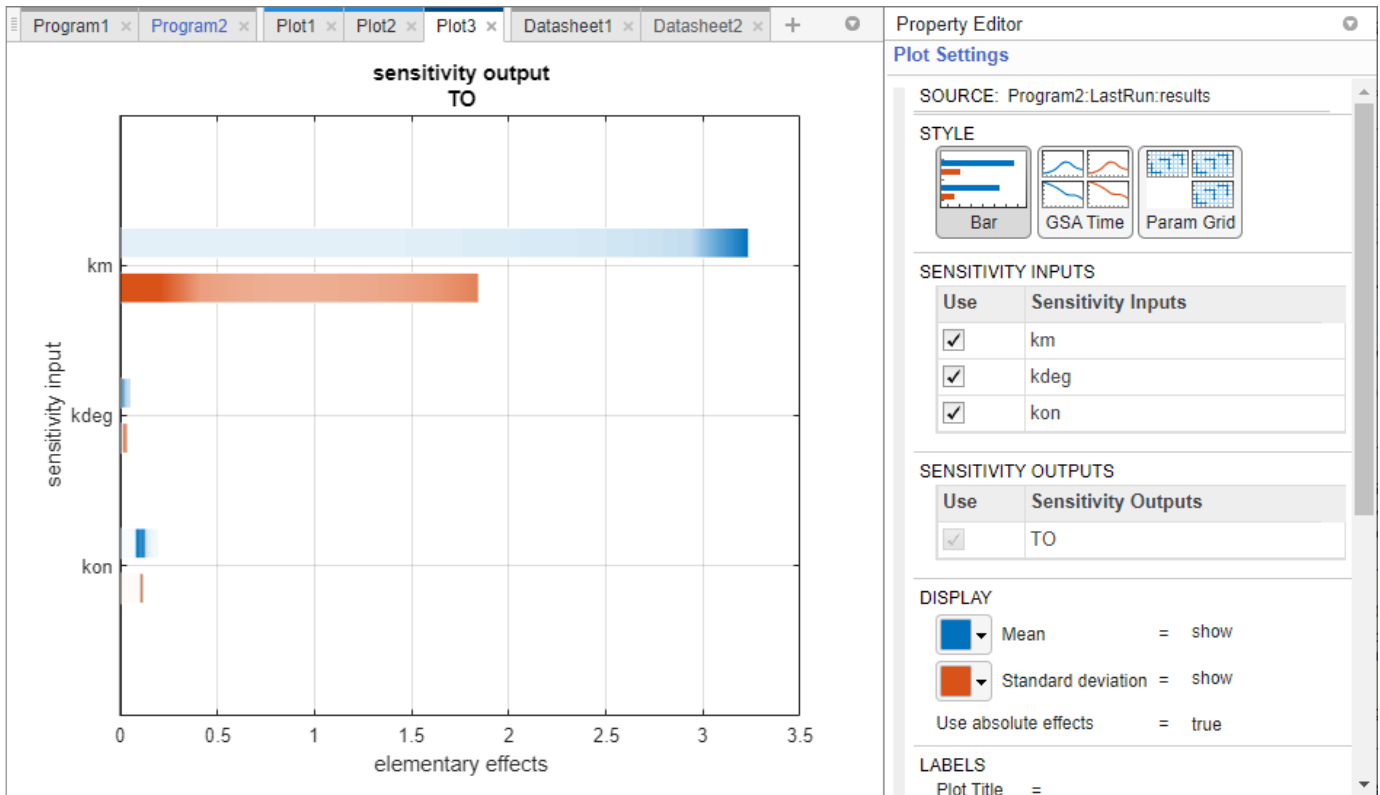

- 9 Click the **Datasheet2** tab to view the tables of GSA program results. The first table shows the time dependent responses of elementary effects. In the second table, you can find out if any model simulation failed during the computation by checking the **Number of Successful Samples** row. In this example, there were no failed simulations as all 1000 samples were successfully simulated.

Perform Multiparametric GSA (MPGSA)

The following steps show you how to reuse the same program set up in the previous step to perform multiparametric global sensitivity analysis on page 4-19 to answer the question of whether the input parameters have any effects on the exposure (area under the curve of the *TO* profile) threshold for the target occupancy.

- 1 Save the previous elementary effects GSA results before switching over to MPGSA. In the **Browser** panel, expand **Program2**. Right-click **LastRun** and select **Save Data**. Enter the name of the data as `ee_results`. Click **OK**.
- 2 Click the **Program2** tab. In the **Elementary Effects** step, under the **Analysis** section, select **Elementary effects > MPGSA (multi-parametric global sensitivity analysis)**.

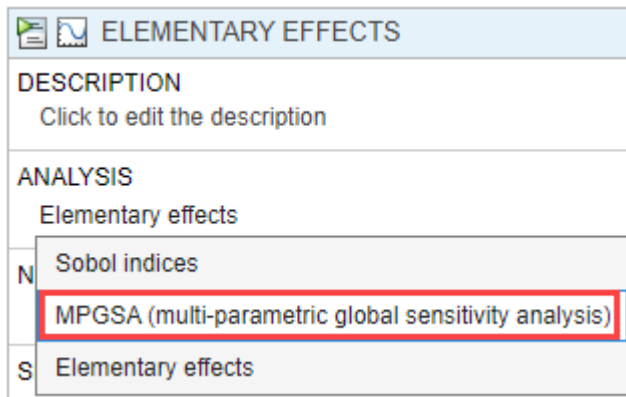

- 3 The stop time is set to 2 and the **Sensitivity Inputs** table is automatically set up with the same number of samples (1000) and the same set of parameters, with their corresponding upper and lower bounds as the previous GSA analysis.
- 4 Use default settings for **Sampling Options** and **Correlation Matrix**.

SAMPLING OPTIONS

Type = sobol sampling with rank correlation matrix
 Skip = 1
 Leap = 0
 Point Order = standard
 Scramble Method = none

Correlation Matrix

	km	kdeg	kon
km	1	0	0
kdeg	0	1	0
kon	0	0	1

- 5 In the **Classifiers** table, double-click the empty cell in the **Expression** column and enter: `trapz(time, TO) <= 0.5`. This expression defines an exposure (area under the curve of the *TO* profile) threshold for the target occupancy.
- 6 Use the default value (0.05) for **Significance Level**.
- 7 Click the Run button of the **MPGSA** step. You might see a warning about dimensional analysis not being able to perform. For the purposes of this example, you can ignore the warning.

Tip

- The GSA program enables you to perform **MPGSA** as a standalone analysis or as an added step following the **Sobol Indices** or **Elementary Effects** analysis. A benefit of adding **MPGSA** as a subsequent step is that it can reuse the simulation results from the previous step if possible and saves computation time. To add MPGSA as a subsequent step, click the green plus icon at the top of the GSA program and click MPGSA.

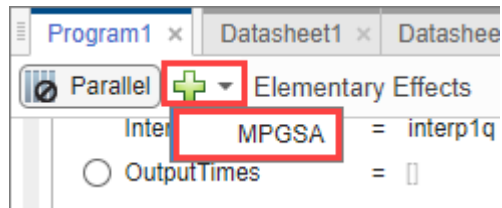

- The MPGSA subsequent step reuses the simulation results whenever the model response (such as **TO**) defined in the classifier was used as the sensitivity output in the previous step.

- 8 The program then opens **Datasheet3** with GSA results and **Plot4** showing the bar plot of the MPGSA results for each input parameter. To see the empirical cumulative distribution functions (eCDFs) curves of the results, click **eCDF** in **Plot Settings**.

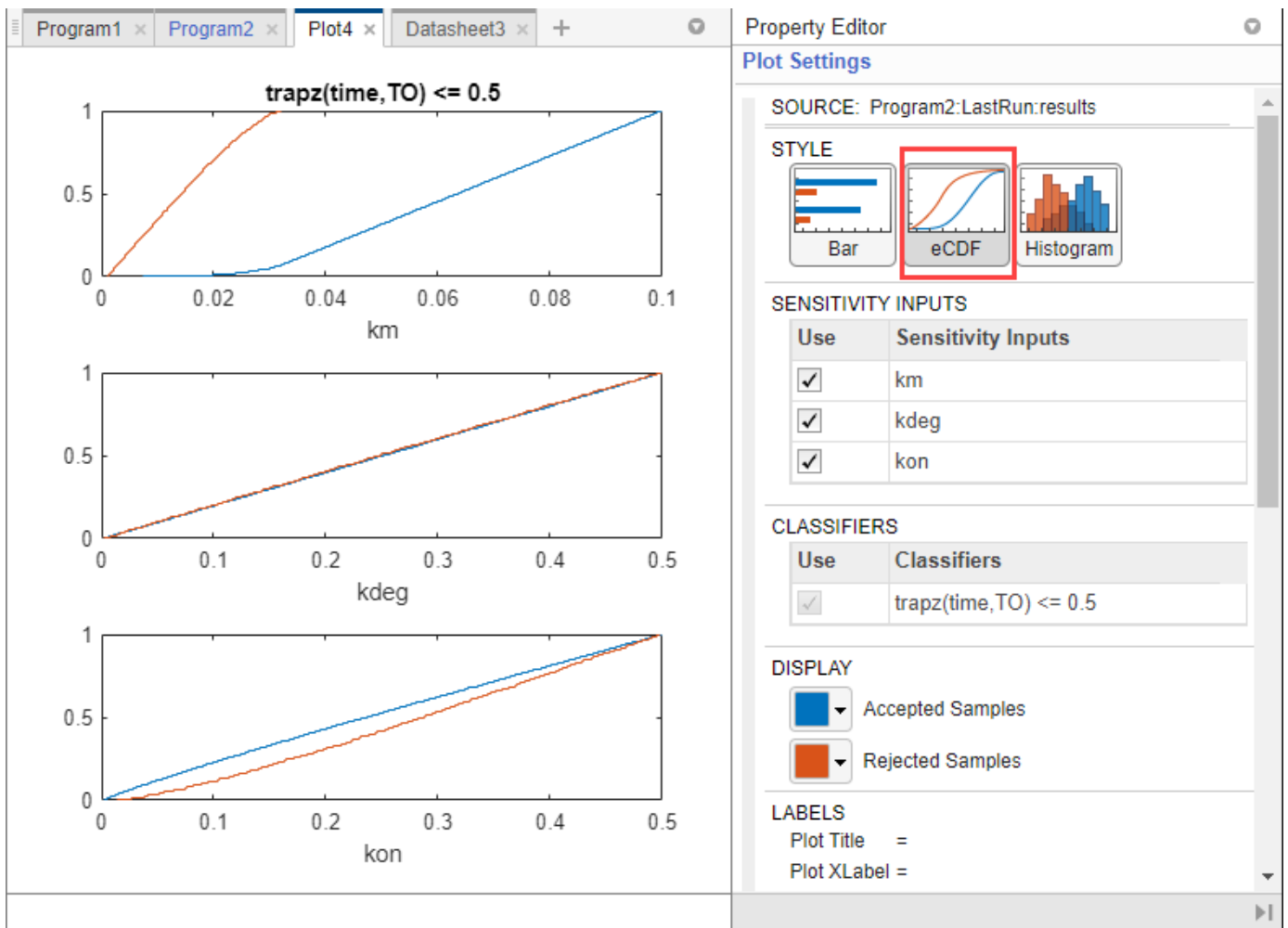

For each parameter, two curves show eCDFs of the accepted and rejected samples. Except for *km*, the other two parameters do not seem to show a significance difference between the two curves. These plots qualitatively show that *km* and *kon* affect the classification of samples while *kdeg* does not. Quantitatively, the maximum absolute distance between two eCDFs curves is called the Kolmogorov-Smirnov (K-S) distance. The *km* plot shows a large K-S distance.

To compute the K-S distance between the two eCDFs, SimBiology uses a two-sided test based on the null hypothesis that the two distributions of accepted and rejected samples are equal. See `kstest2` for details. If the K-S distance is large, then the two distributions are different, meaning that the classification of the samples is sensitive to variations in the input parameter. On the other hand, if the K-S distance is small, then variations in the input parameter do not affect the classification of samples.

- 9 To assess the significance of the K-S statistic rejecting the null-hypothesis, you can examine the p-values by looking at the bar plot. Click **Bar** in the **Plot Settings**.

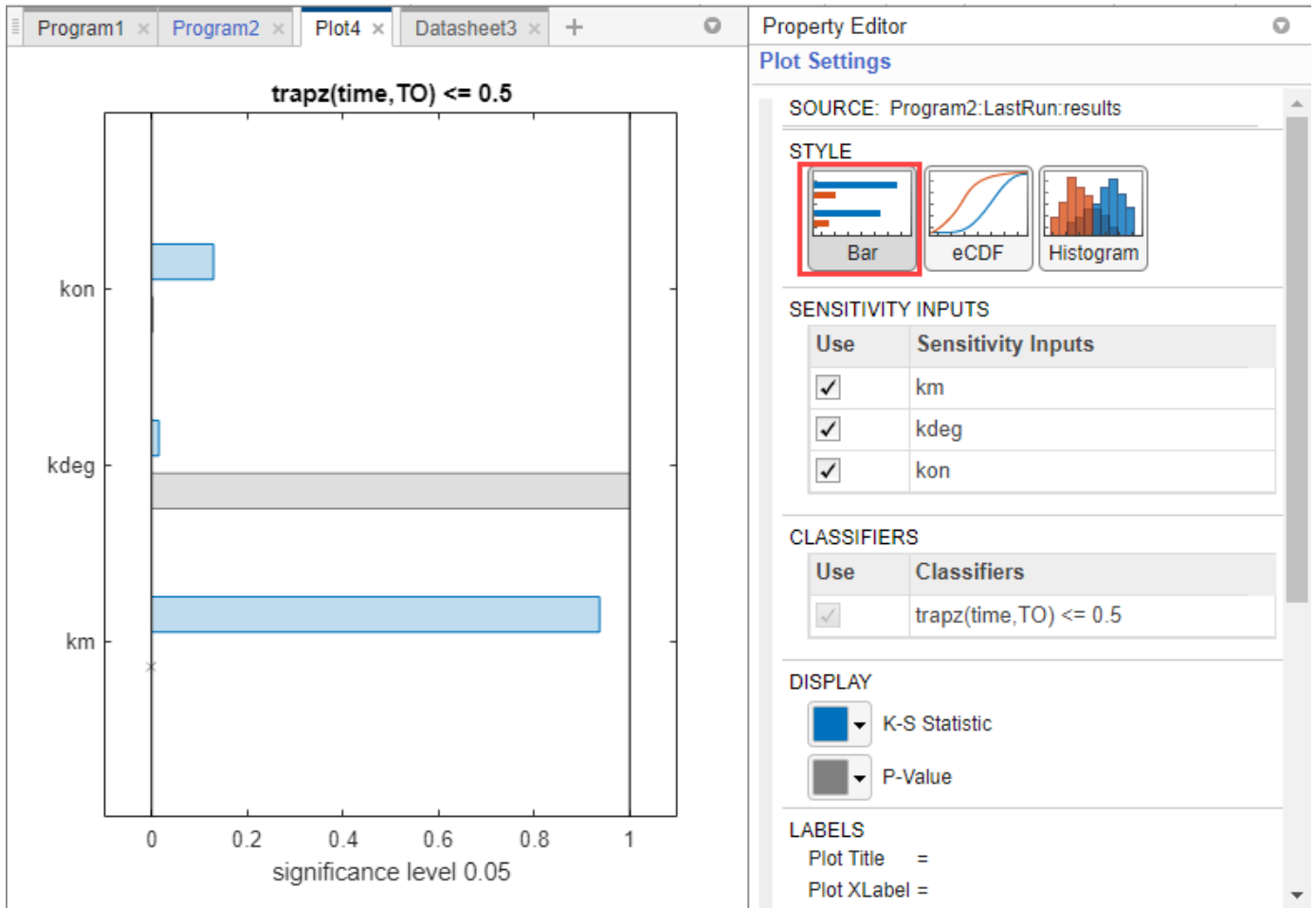

The bar plot shows two bars for each parameter: one for the K-S distance (K-S statistic) and another for the corresponding p-value. You reject the null hypothesis if the p-value is less than the significance level. A cross (x) is shown for any p-value that is almost 0.

The p-values for *km* and *kon* are less than the significance level (0.05), supporting the alternative hypothesis that the accepted and rejected samples come from different distributions. The p-value of *kdeg* is larger than the significance level supporting the null hypothesis that the accepted and rejected samples come from the same distribution. To conclude, the classification of the samples is sensitive to *km* and *kon*, not *kdeg*. These results are in agreement with the previous GSA results which identify *km* and *kon* as sensitive parameters but not *kdeg*.

- 10 To see the exact p-value corresponding to each parameter, click **Datasheet3**.

Kolmogorov Smirnov Statistics (Program2: LastRun)

		Classifier
	Parameter	trapez(time,TO) <= 0.5
1	km	0.9370
2	kdeg	0.0151
3	kon	0.1295

PValues (Program2: LastRun)

		Classifier
	Parameter	trapez(time,TO) <= 0.5
1	km	2.4693e-151
2	kdeg	1.0000
3	kon	0.0026

MPGSA Sample Information (Program2: LastRun)

	Property	Value
1	Number of Samples	1000
2	Number of Successful Samples	1000

Histogram of Accepted and Rejected Samples

You can also check the histogram of accepted and rejected samples to see if there are any trends. Click the **Plot4** tab. Click **Histogram** in the **Plot Settings**. The histogram of *km* shows that *km* is primarily responsible for the sensitivity of the AUC being less than the threshold 0.5.



See Also

SimBiology Model Analyzer | sbiosobol | sbioelementaryeffects | sbiompgsa | ecdf | kstest2

More About

- “Sensitivity Analysis in SimBiology” on page 4-19

View and Run Generated Code by SimBiology Model Builder

You can generate MATLAB code for modeling actions that you perform in the **SimBiology Model Builder** app using the **Code Capture** tool. The tool is useful to learn how to build SimBiology models programmatically or to automate common model building actions at the command line. The generated code shows, for example, how to add model components, configure block properties in the diagram, and change simulation settings programmatically. The following example shows you how to generate code to modify model parameter values and change diagram block properties, save the code as a function file, and run it at the command line.

Load Bioavailability Model

Load the bioavailability model in the **Model Builder** app. For details about the model, see “Estimating the Bioavailability of a Drug” on page 4-78.

At the MATLAB command line, enter:

```
simBiologyModelBuilder("Bioavailability.sbproj");
```

Generate Code for Updating Model Components and Graphical Block Properties

The next sets of instructions show you how to perform the following modeling actions and generate equivalent MATLAB code:

- Changing values of some model parameters
- Adding a new compartment
- Changing the color of all species blocks

Open Code Capture Tool

- 1 On the **Home** tab of the app, select **Tools > Code Capture**. The app shows the generated code in the **Code** tab of the **Model Tools** panel for your modeling actions.

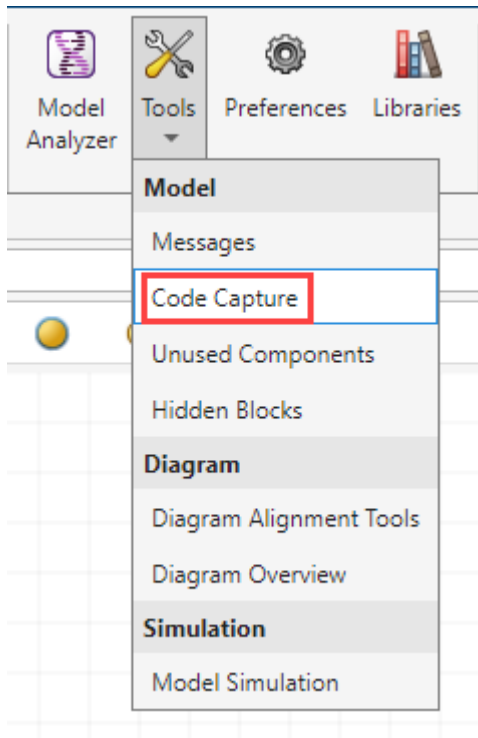

Alternatively, you can expand the **Model Tools** panel and click **Code**.

The screenshot displays the SimBiology Model Builder interface. At the top, a dark blue header bar contains the word "Browser" with a dropdown arrow. Below this, the text "Project | Model" is visible. A search bar and several icons (magnifying glass, dropdown, up arrow, gear, funnel) are located to the right of the search bar. Below the search bar, the text "Bioavailability Model" is displayed with a plus icon on the left and several icons on the right. The main area is titled "COMPARTMENTS AND SPECIES" and contains a table with the following data:

	Name	Value	Units
1	Blood_Plasma	1	liter
2	Drug_Central	0	milligram/liter
3	GI_Compartment	1	liter
4	Drug_Oral	0	milligram
5	Add Compartment		

Below the table, the "Model Tools" section is visible, with tabs for "Messages", "Code", "Unused", "Hidden", and "Overview". The "Code" tab is highlighted with a red box. Below the tabs, there are icons for "Save" and "Clear", followed by the text "Capture object and diagram code". The main area below this is a large text editor with a single line of code starting with "1" and a vertical cursor.

Tip

- By default, the **Code Capture** tool continuously generates code for most modeling actions (see here on page 1-175 for exceptions) that you do in the app. Specifically, it generates code for model component (object) changes and diagram (graphical) changes. You can choose to generate code for object changes only, diagram changes only, both, or neither (the tool is turned off when you select neither option).

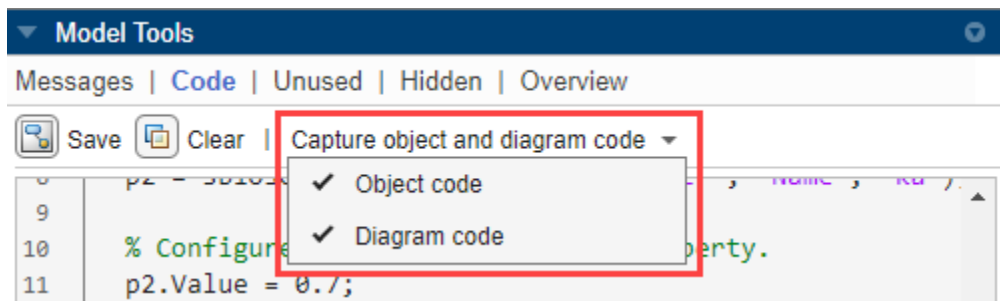

- To capture code for just the actions that you are interested in learning or automating, you can first remove any existing code right before performing those actions by clicking the **Clear** button of the tool. Alternatively, you can turn off the tool and turn it back on right before the actions.

Change Model Parameter Values

In the **Browser** panel, scroll down to the **Parameters** table. Change the values of parameters F (bioavailability of a drug) and ka (total rate of elimination) to 0.5 and 0.7, respectively.

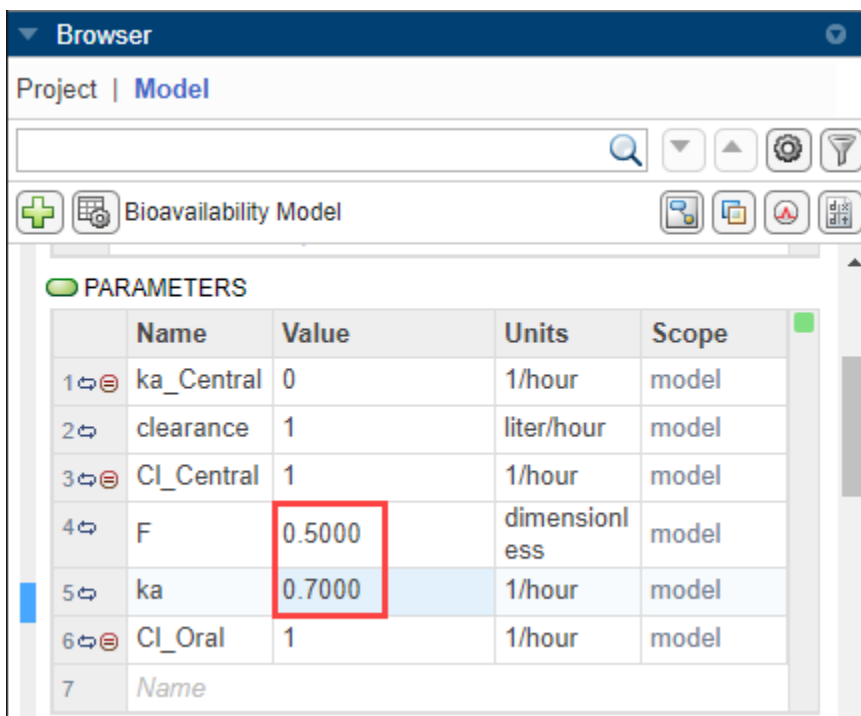

The **Code Capture** tool shows the following code.

```
% Query object.
p1 = sbioselect(m1, 'Type', 'parameter', 'Name', 'F');

% Configure SimBiology component property.
p1.Value = 0.5;

% Query object.
p2 = sbioselect(m1, 'Type', 'parameter', 'Name', 'ka');
```



```
% Configure SimBiology component property.
p2.Value = 0.7;
```

Add New Compartment

- 1 Drag and drop a compartment block into the diagram.

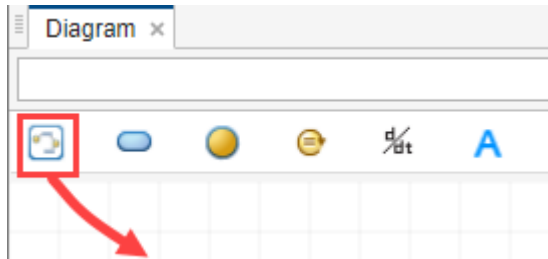

- 2 Double-click **compartment_1** and rename to **Brain**.
- 3 Drag and drop a species block into the **Brain** compartment.

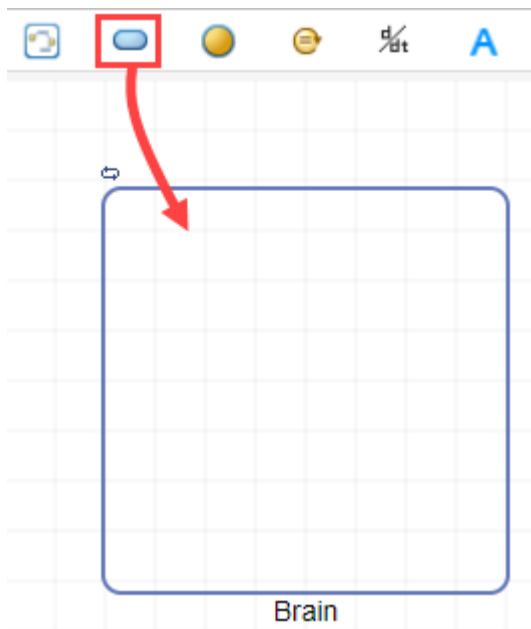

- 4 Double-click **species_1** and rename to **Drug_Brain**.

The **Code Capture** tool shows the following code.

```
% Add compartment to model.
c1 = addcompartment(m1, 'compartment_1');

% Rename SimBiology component.
rename(c1, 'Brain');

% Add species to compartment.
s1 = addspecies(c1, 'species_1');

% Rename SimBiology component.
rename(s1, 'Drug_Brain');
```

Change Color of Species Block

- 1 Click the species **Drug_Brain** in the diagram.
- 2 In the **Property Editor** pane, under the **Appearance** section, click **Face Color** and select the green color. Click **OK**.

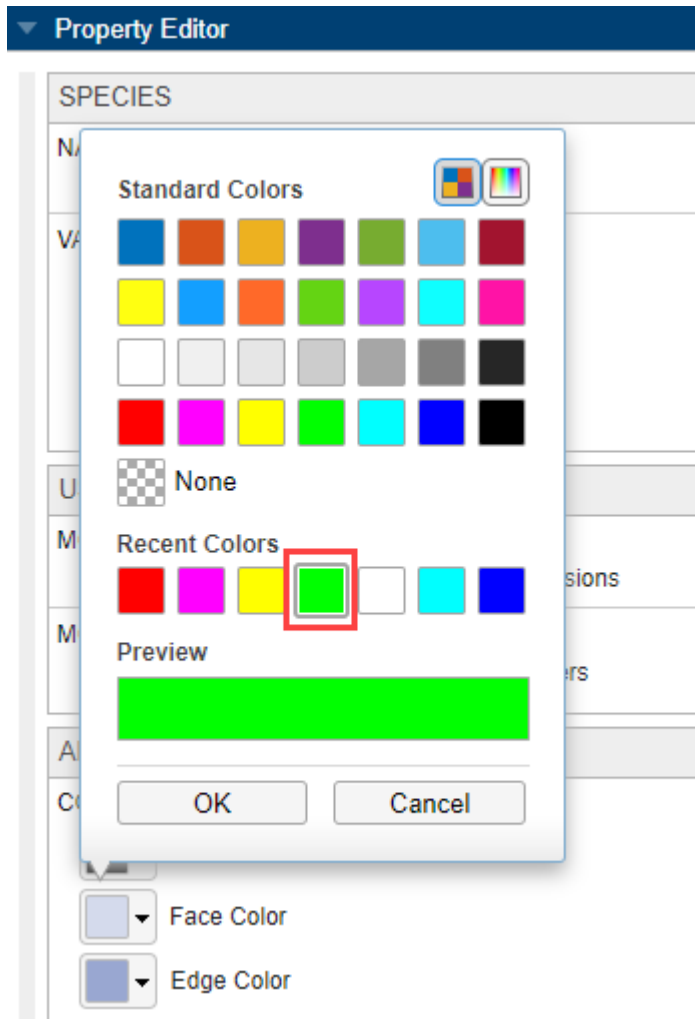

The **Code Capture** tool shows the following code.

```
% Configure SimBiology block property.
simbio.diagram.setBlock(s1, 'FaceColor', [0, 1, 0]);
```

Tip For details about this function, see `simbio.diagram.setBlock`.

Save Generated Code

- 1 Click **Save** in the toolbar of the **Code Capture** tool.

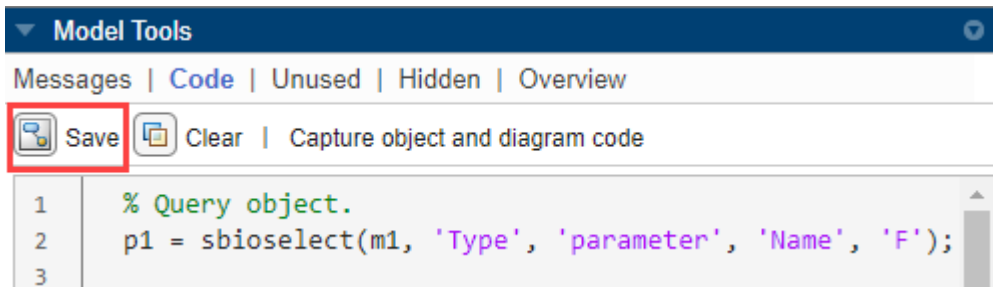

- The app then creates an untitled function file in the MATLAB editor with the generated code in it. Click **Save** and save the file to your local folder using `runcode.m` as the file name.

Modify Generated Code

For the purposes of this example, modify the code for the following changes:

- Change the parameter values of F and ka to different values.
 - Add a new compartment called **Liver** with a species in it.
 - Change the color of all (instead of one) species in the model to green.
- In the `runcode.m` file, change the values of $p1$ (parameter F) and $p2$ (parameter ka).



```
p1.Value = 0.4;
p2.Value = 0.6;
```
 - To add a new compartment called **Liver** with a species named **Drug_Liver**, update two lines of code to rename the compartment $c1$ and species $s1$ as follows.

```
rename(c1, 'Liver');
rename(s1, 'Drug_Liver');
```
 - To change the color of all species to the green color, comment out the `setBlock` line of code and add two new lines of code as follows.

```
% simbio.diagram.setBlock(s1, 'FaceColor', [0, 1, 0]);
allSpecies = sbioselect(m1, 'Type', 'species');
simbio.diagram.setBlock(allSpecies, 'FaceColor', [0, 1, 0]);
```

Run Generated Code

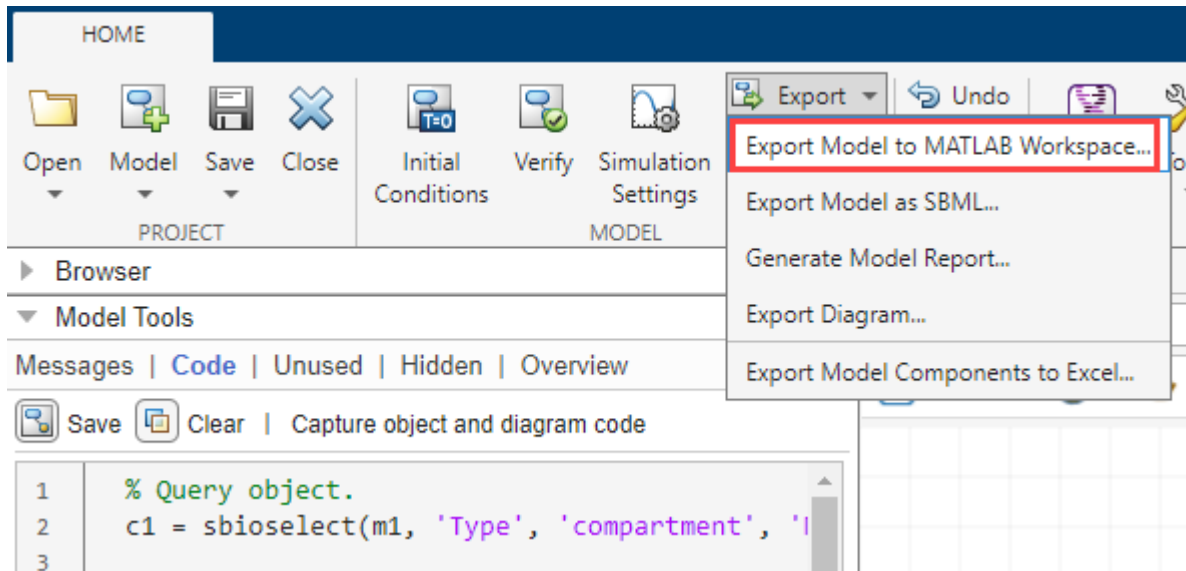
- To run `runcode.m` at the command line, you first need to export the corresponding model from the app to the workspace. Go back to the **Model Builder** app. Select **Export** > **Export Model to MATLAB Workspace**. Specify the model name as $m1$, keep the overwrite check box selected, and click **OK**.



- 2 Keep the app open because the generated code contains graphical changes.

Tip If you have only model component (object) changes, you can optionally close the app after exporting the model to the workspace.

- 3 Next, change the current directory to where the `runcode.m` file is saved. One way to do this is to go back to the **Editor** window. Right-click the `runcode.m` tab and select **Change Current Folder to**.

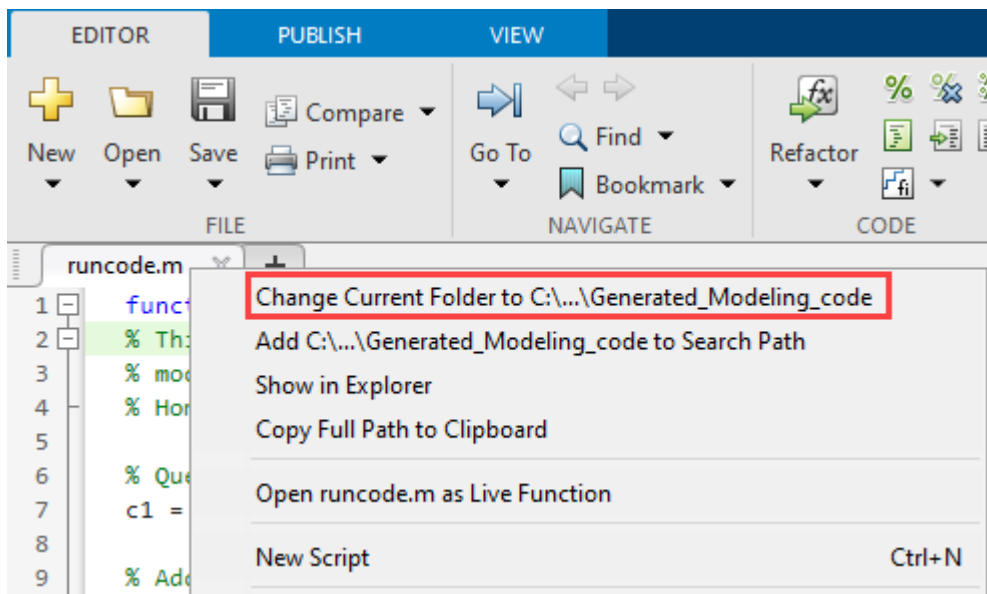

- 4 At the command line, enter:
`runcode(m1);`
- 5 Go back to the **Model Builder** app to verify the changes you made.

Actions Not Captured

The **Code Capture** tool does not generate code for the following actions in the app.

- Undoing and redoing
- Copying and pasting
- Dragging or moving a block in the diagram
- Diagram layout changes from using the context menu options, such as **Layout Method** and **Layout Diagram**
- Using the **Diagram Alignment Tools** to align blocks
- Configuring **States To Log** in **Simulation Settings**
- Updating the **Notes** section of **Property Editor**
- Using the Model Simulation on page 1-35 tool

See Also

SimBiology Model Builder | `simbio.diagram.getBlock` | `simbio.diagram.getLine` | `simbio.diagram.setBlock` | `simbio.diagram.setLine` | `simbio.diagram.splitBlock` | `simbio.diagram.joinBlock`

Related Examples

- “View and Run Program Code Generated by SimBiology Model Analyzer” on page 1-130

Import and Export Variants and Doses from Excel to SimBiology Model Builder

You can store variant and dosing information in an Excel spreadsheet that you can import to the **Model Builder** app and create the corresponding variants and doses for your models. You can also export the existing variants and doses from a SimBiology model to an Excel file.

Import Variants from Excel

- 1 In the **Model Builder** app, on the **Home** tab, select **Model** > Import Model Components from Excel.

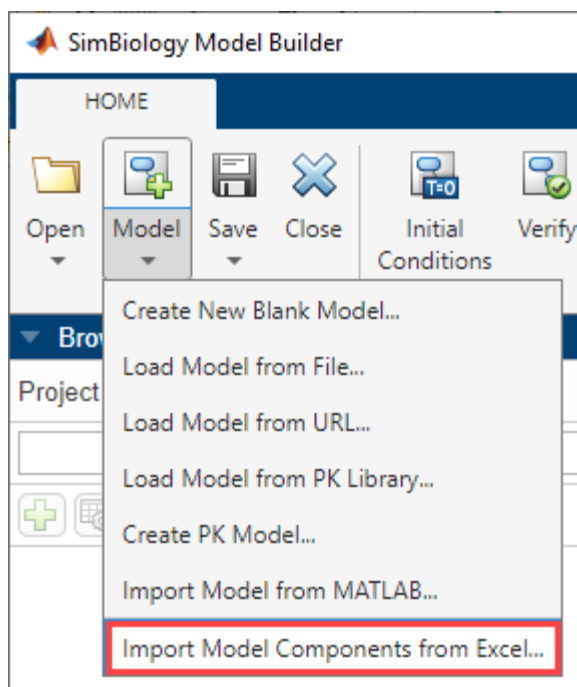

- 2 Select your Excel file containing variants. In the next dialog, select **Variants** in the **Components** table. The **Properties** table is then updated to show the required properties that need to be defined in the Excel sheet. These required properties are preselected and cannot be unchecked.

Depending on if you have stored all the variants in one sheet or multiple sheets, the workflow differs as shown next. For details on making such an Excel file, see “Create Excel File for Variants” on page 1-179.

Tip You can also generate the Excel file by exporting an existing variant on page 1-178 from your model.

Variants in One Sheet

If you have stored the information of all the variants in one sheet, select the check box **Variants defined in one sheet** and select the corresponding sheet name in the **Sheet Name** list.

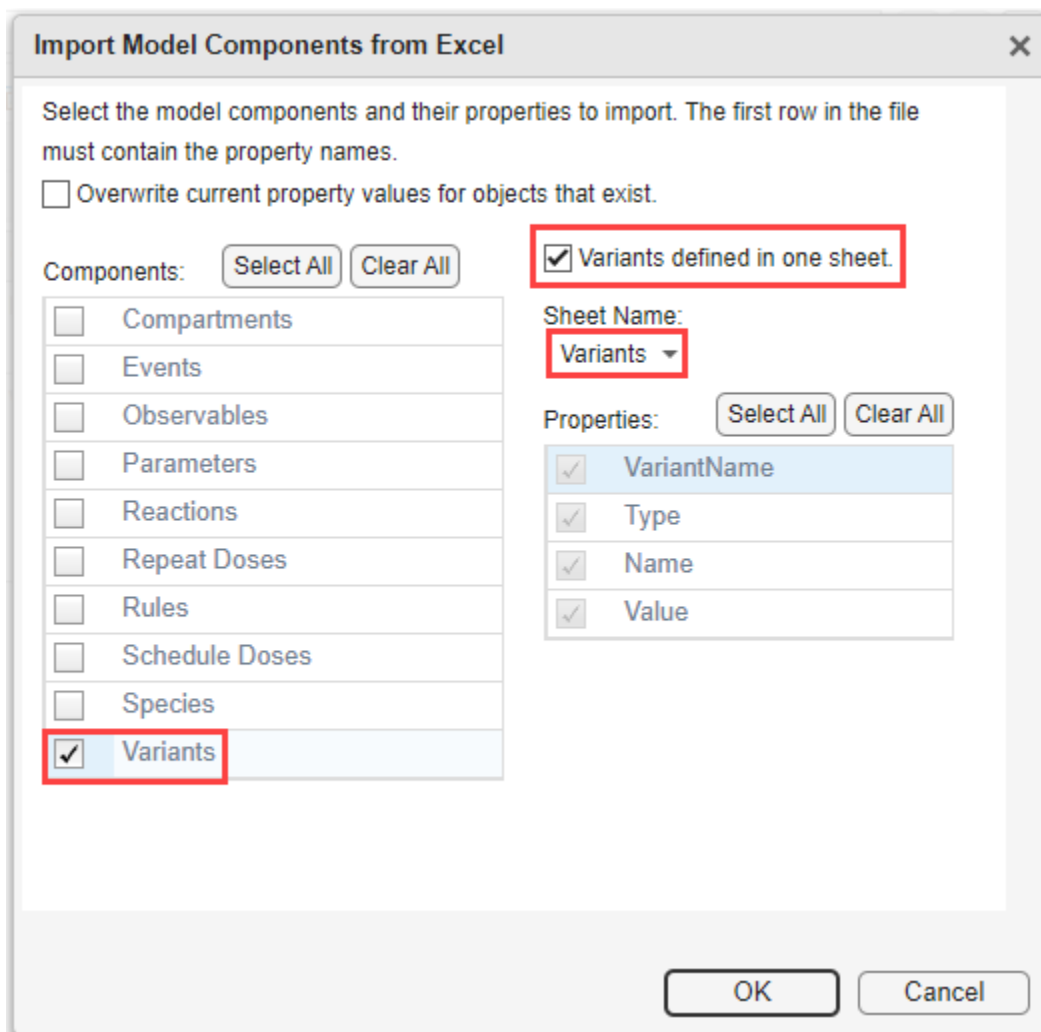

Variants in Multiple Sheets

If you have stored variants in multiple sheets, clear the check box and select which sheets to import in the **Sheet Names** table.

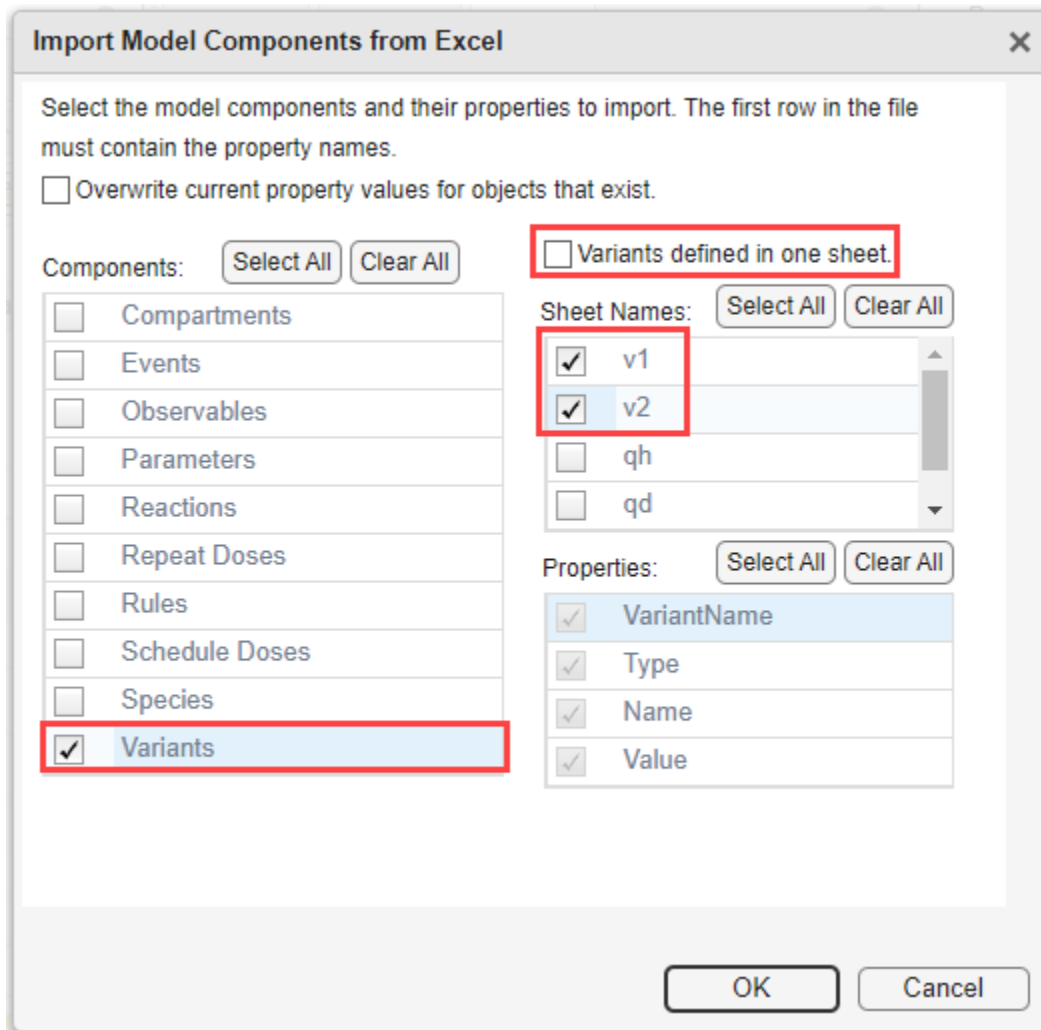

Export Variants to Excel

- 1 On the **Home** tab of the **Model Builder** app, select **Export** > Export Model Components to Excel.

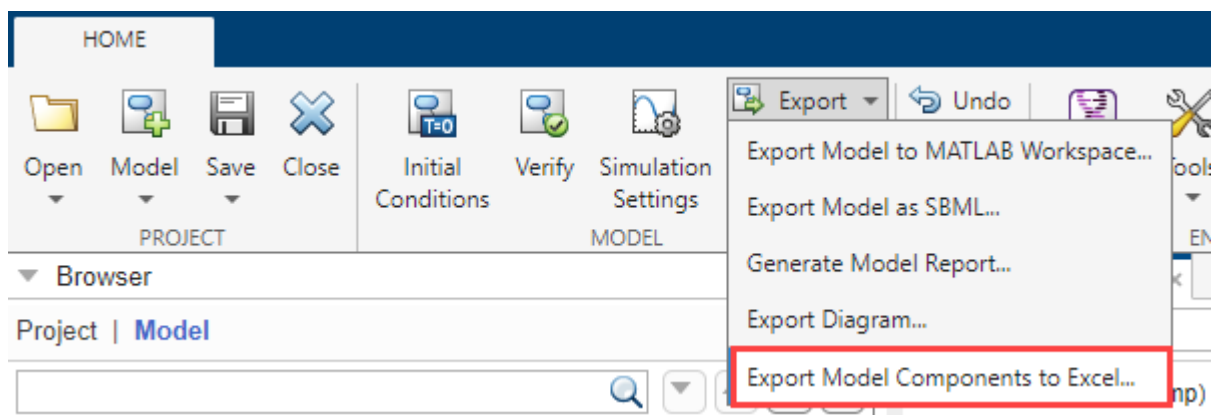

- 2 In the next dialog, select **Variants** in the **Components** table. The **Properties** table on the right is then updated to show which properties are exported. Each property is exported as a column in the spreadsheet.
- 3 (Optional) By default, the app stores all variants in one sheet. If you want to store one variant per sheet, clear the **Write variants to one sheet** check box.

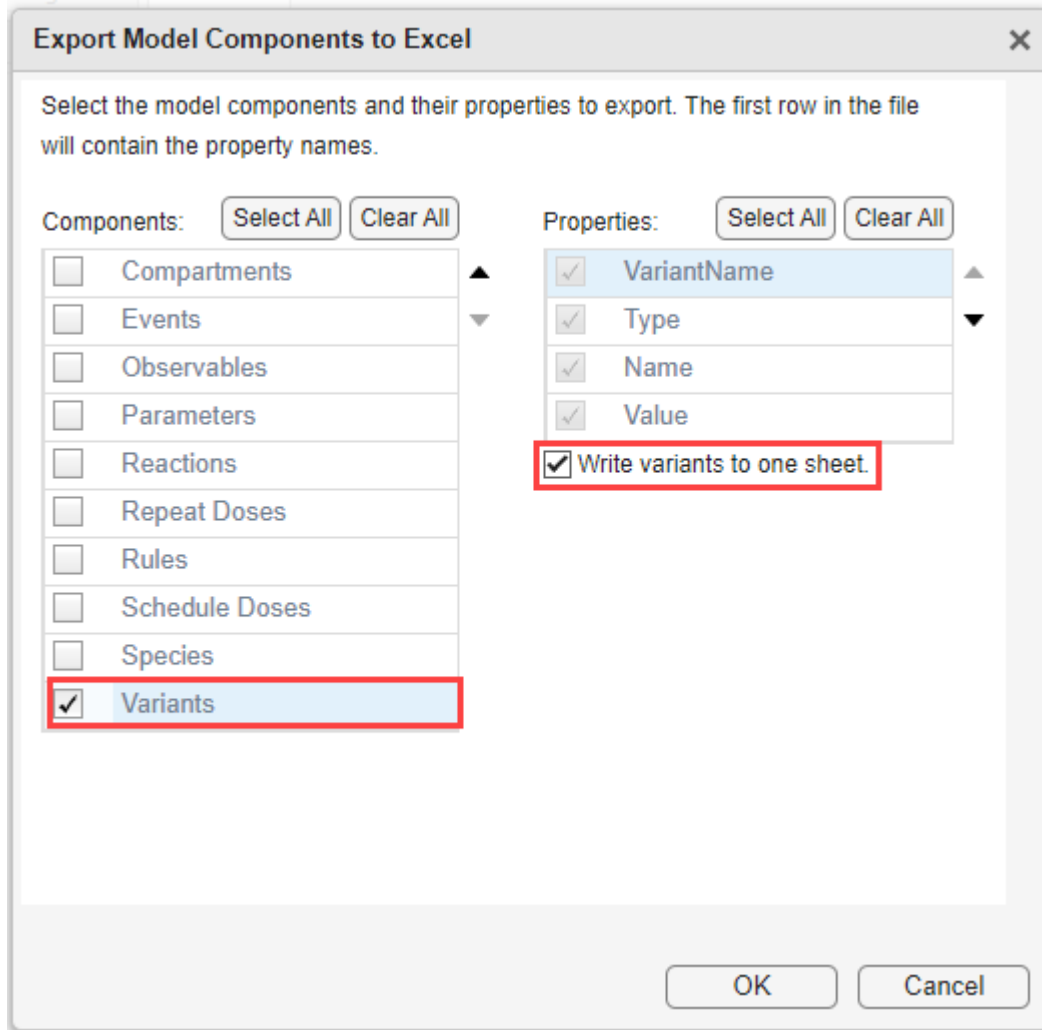

Tip You can change the order of columns by pressing the up and down arrows on the right of the **Properties** table.

Create Excel File for Variants

You can store the variant information in one sheet or multiple sheets within one Excel file.

Store Variants in One Sheet

The sheet must have the **Type** column, the **Name** column, and one column for each variant that contains the variant values. Each variant column name must be the same as the corresponding

variant name. The **Type** column corresponds to the model component type (species, parameter, or compartment). The **Name** column is the model component name. You can leave the cell empty or use NaN or ' .' (a period) to indicate that there is no variant value for a particular component. Here is an example of what such a sheet looks like.

	A	B	C	D
1	Type	Name	v1	v2
2	parameter	ka_Central	0.5	0.8
3	species	Central.Dose_Central	1	0.6
4				
5				

Navigation: Variants | ScheduleDoses | R...

Note The transposed version of this format, where each row is a variant and each column is a model component, is not supported.

Store Variants in Multiple Sheets

Each sheet must have the following columns:

- **VariantName** — Name of the variant. The app uses this name when creating the variant.
- **Type** — Model component type (species, parameter, or compartment)
- **Name** — Model component name
- **Value** — Model component value

The next screenshot shows an example of what such an Excel file with multiple sheets looks like.

	A	B	C	D
1	VariantName	Type	Name	Value
2	v1	parameter	ka_Central	0.5
3	v1	species	Central.Dose_Central	1
4				
5				

Navigation: v1 | v2 | qh | qd | bid | (+)

Import Doses from Excel

- 1 On the **Home** tab of the app, select **Model** > Import Model Components from Excel. Select your Excel file containing the dosing information. You can store multiple schedule doses in one or multiple sheets. All repeat doses must be saved in one sheet.
- 2 In the next dialog, select the dosing type stored in the Excel sheet: **Schedule Doses** or **Repeat Doses** (or both) in the **Components** table. When you click **Schedule Doses** or **Repeat Doses** row, the **Properties** table on the right is updated automatically to show the corresponding

required properties that need to be defined in the Excel sheet. These required properties are preselected and cannot be unchecked.

- 3 If the Excel sheet also has columns for the optional properties (such as **Rate** or **AmountUnits**) that you want to import, select the corresponding check boxes in the **Properties** table as well.
- 4 For the repeat doses, select the corresponding sheet under **Sheet Name**.

The screenshot shows the SimBiology Model Builder interface. On the left, under 'Components:', there is a list of components with checkboxes. 'Repeat Doses' is checked and highlighted in blue. Above this list are 'Select All' and 'Clear All' buttons. On the right, under 'Sheet Name:', a dropdown menu is set to 'RepeatDoses'. Below that, under 'Properties:', there is another list of properties with checkboxes. The checked properties are Name, TargetName, StartTime, Amount, Interval, RepeatCount, and AmountUnits. The unchecked properties are Rate and RateUnits. Above this list are 'Select All' and 'Clear All' buttons.

- 5 For schedule doses, depending on if you have stored the schedule doses in one sheet or multiple sheets, the workflow differs as shown next.

For details on making an Excel file for schedule or repeat doses, see “Create Excel File for Doses” on page 1-184. Alternatively, you can export an existing dose from your model to Excel to look at it as an example.

Schedule Doses in One Sheet

Select the check box **Schedule doses defined in one sheet** and select the corresponding sheet name in the **Sheet Name** list.

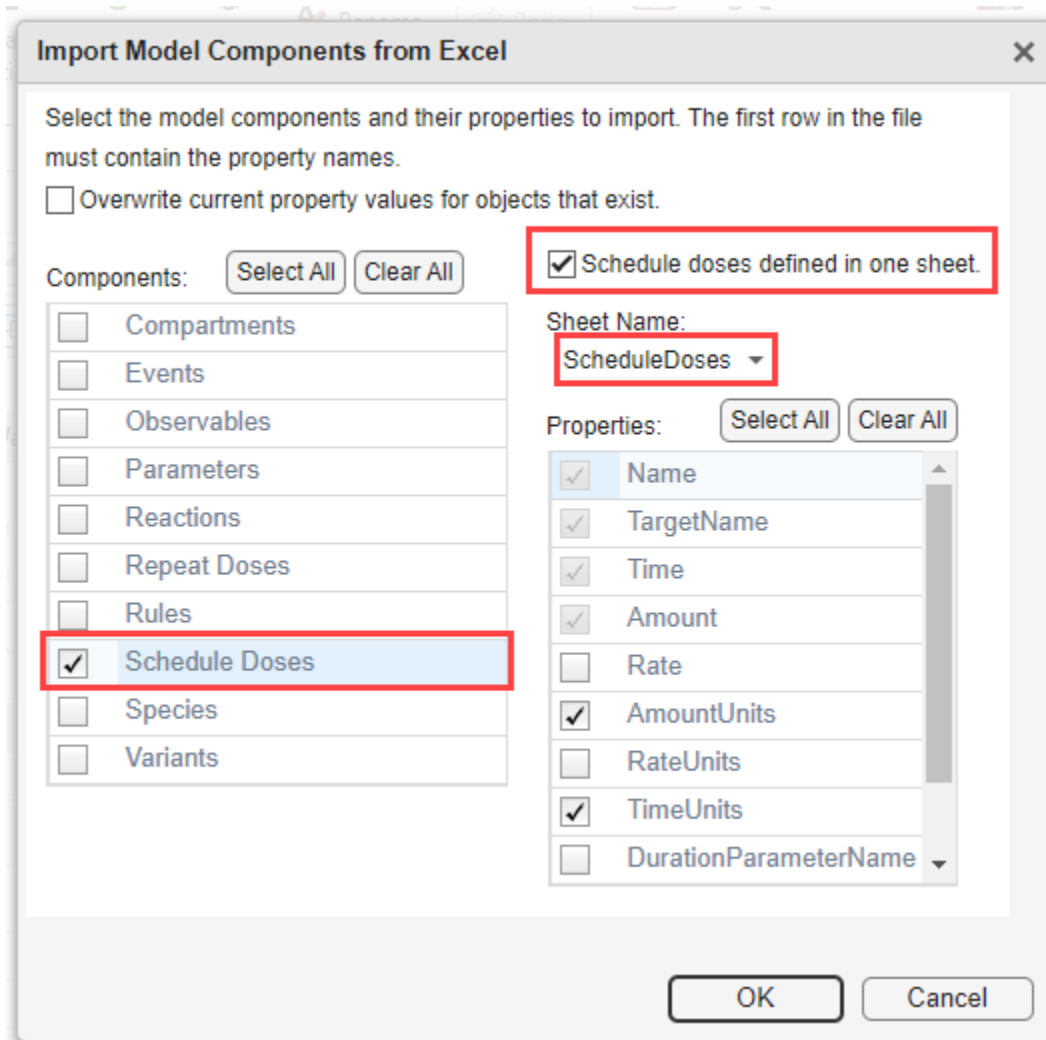

Schedule Doses in Multiple Sheets

Clear the check box **Schedule doses defined in one sheet** and select which sheets to import in the **Sheet Names** table.

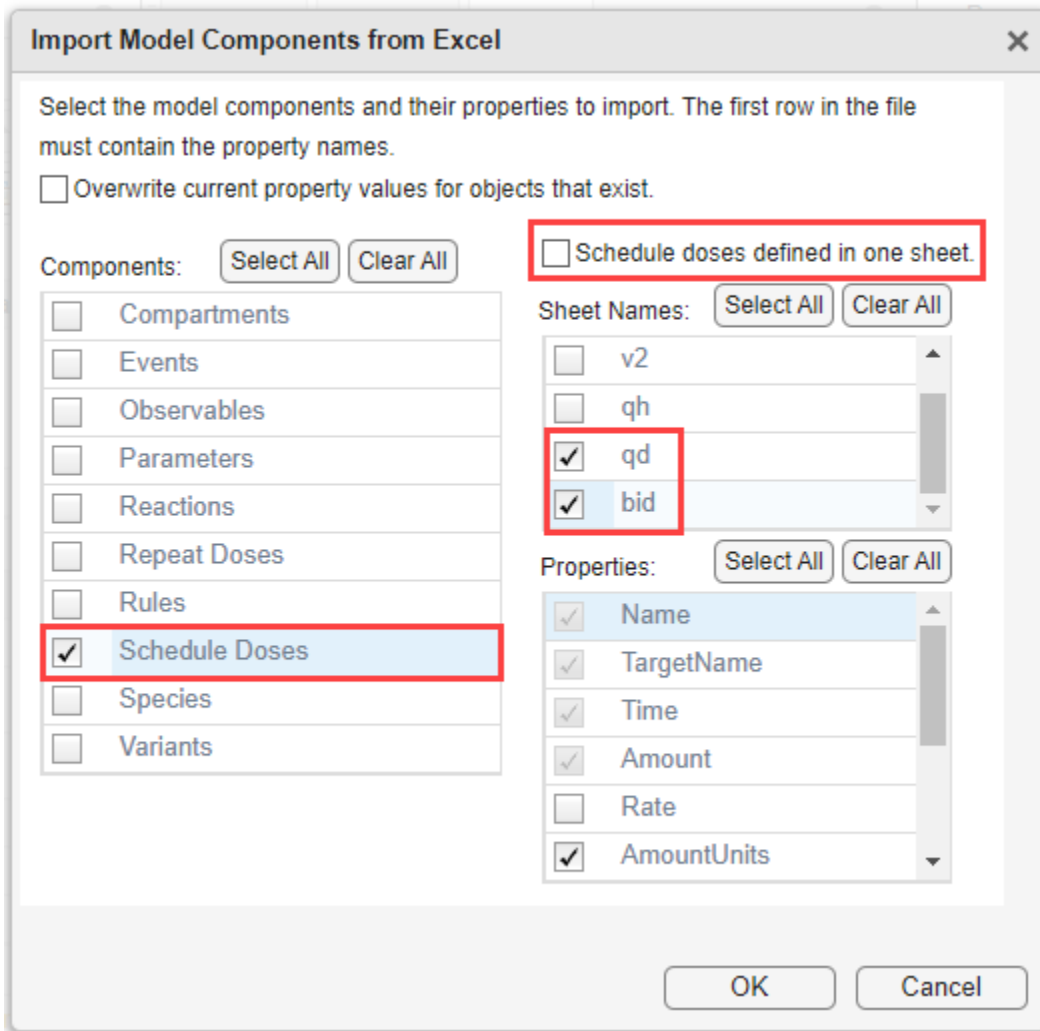

Export Doses to Excel

- 1 On the **Home** tab of the app, select **Export** > Export Model Components to Excel.

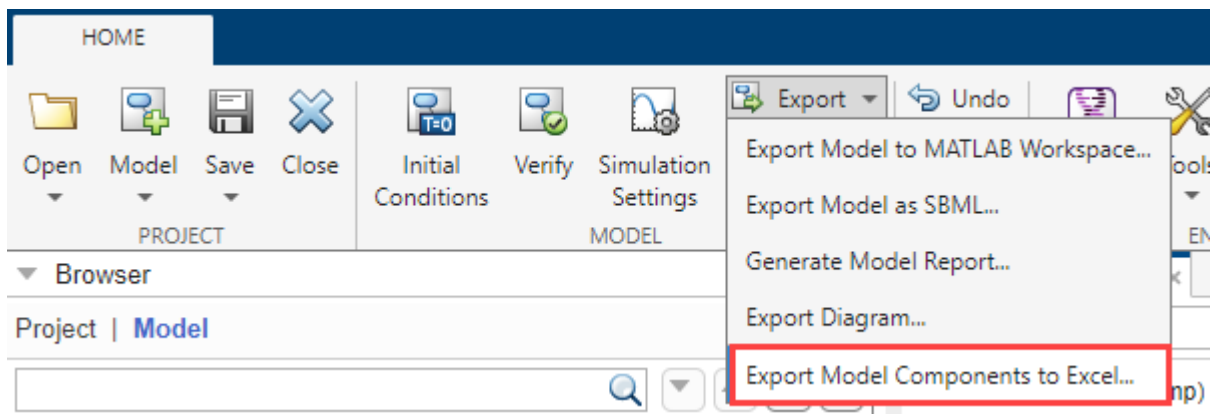

- 2 In the next dialog, select **Repeat Doses** or **Schedule Doses** (or both) in the **Components** table. The **Properties** table on the right is then updated to show which properties are exported. Each property is exported as a column in the spreadsheet.
- 3 (Optional) By default, the app stores all schedule doses in one sheet. If you want to store one schedule dose per sheet, clear the **Write schedule doses to one sheet** check box. The repeat doses can only be stored in one sheet. You can change the order of columns by pressing the up and down arrows on the right of the **Properties** table.

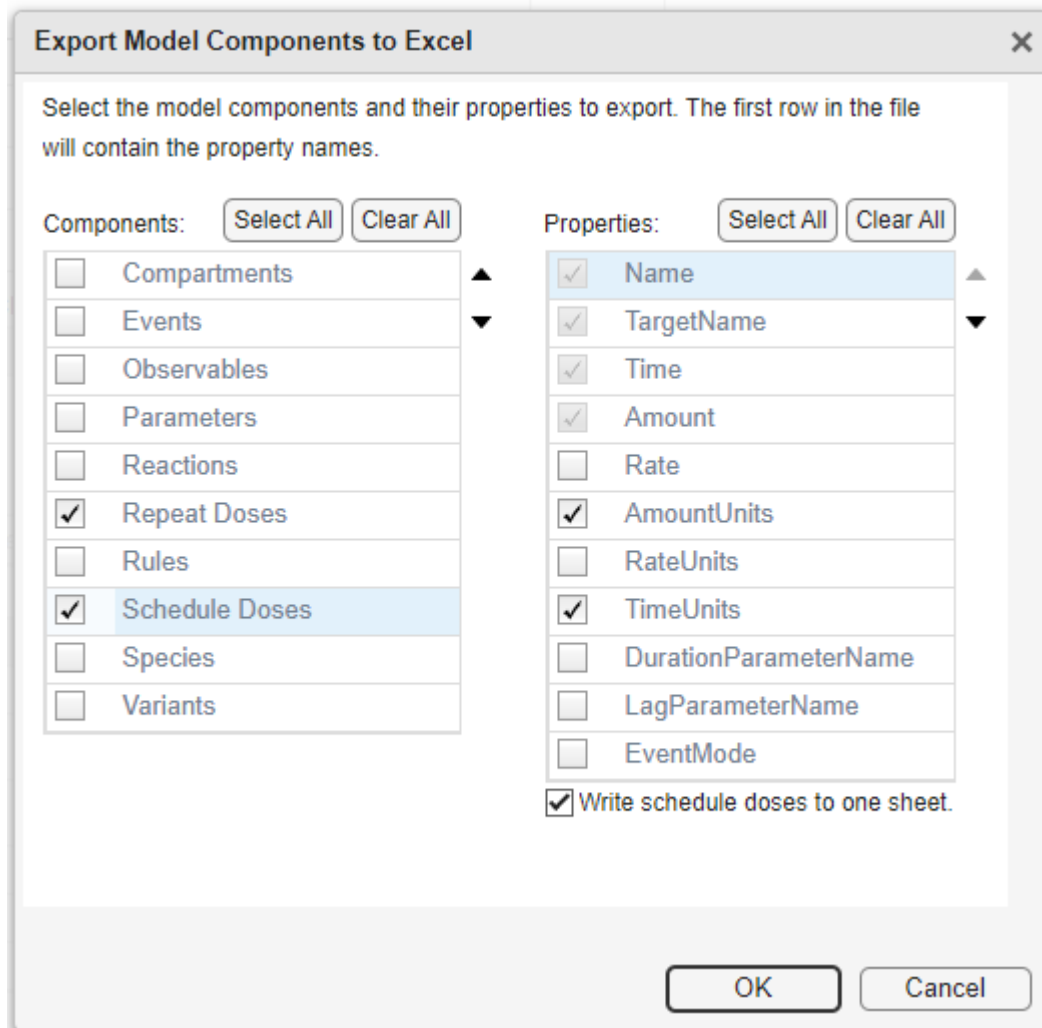

Create Excel File for Doses

For Repeat Doses

Store all repeat doses in one sheet. The sheet must have one row per repeat dose and must have the following columns:

- **Name** — Dose name
- **TargetName** — Name of the dose target

- **StartTime** — Dose start time
- **Amount** — Dose amount

The optional columns are:

- **Rate** — Dose rate
- **Interval** — Time between doses
- **RepeatCount** — Dose repetitions
- **AmountUnits** — Dose amount units
- **RateUnits** — Dose rate units
- **TimeUnits** — Dose time units
- **DurationParameterName** — Parameter specifying length of time to administer a dose
- **LagParameterName** — Parameter specifying time lag for dose
- **EventMode** — Determining how events that change dose parameters affect in-progress dosing

Here is an example of what such a sheet looks like.

	A	B	C	D	E	F	G	H
1	Name	TargetName	StartTime	Amount	Interval	RepeatCount	AmountUnits	TimeUnits
2	d1	Central.Drug_Central	0	50	3	5	milligram	hour
3	d2	Central.Drug_Central	0	20	10	3	milligram	hour
4								
5								
6								

For Schedule Doses

Store all schedule doses in one sheet or use one sheet per dose. The rows in each sheet are monotonically increasing time points with corresponding dose amounts for each schedule dose.

Regardless of using one sheet or multiple sheets, each sheet must have the following columns:

- **Name** — Dose name
- **TargetName** — Name of the dose target
- **Time** — Schedule dose time
- **Amount** — Dose amount

The optional columns are:

- **Rate** — Dose rate
- **AmountUnits** — Dose amount units
- **RateUnits** — Dose rate units
- **TimeUnits** — Dose time units
- **DurationParameterName** — Parameter specifying length of time to administer a dose
- **LagParameterName** — Parameter specifying time lag for dose

- **EventMode** — Determining how events that change dose parameters affect in-progress dosing

Here is an example of storing all schedule doses in one sheet.

	A	B	C	D	E	F
1	Name	TargetName	Time	Amount	AmountUnits	TimeUnits
2	d3	Central.Drug_Central	0	10	milligram	day
3	d3	Central.Drug_Central	1	15	milligram	day
4	d3	Central.Drug_Central	2	20	milligram	day
5	d3	Central.Drug_Central	3	25	milligram	day
6	d4	Central.Drug_Central	0	5	milligram	day
7	d4	Central.Drug_Central	0.5	10	milligram	day
8	d4	Central.Drug_Central	1	15	milligram	day
9	d4	Central.Drug_Central	1.5	20	milligram	day
10						
11						
12						

ScheduleDoses (+)

Here is an example of using one sheet per schedule dose.

	A	B	C	D	E	F
1	Name	TargetName	Time	Amount	AmountUnits	TimeUnits
2	d3	Central.Drug_Central	0	10	milligram	day
3	d3	Central.Drug_Central	1	15	milligram	day
4	d3	Central.Drug_Central	2	20	milligram	day
5	d3	Central.Drug_Central	3	25	milligram	day
6						

d3 d4 (+)

See Also

SimBiology Model Builder | “Doses in SimBiology Models” on page 2-30 | “Variants in SimBiology Models” on page 2-29

Modeling

- “What is a SimBiology Model?” on page 2-2
- “Species Object” on page 2-5
- “Definitions and Evaluations of Reactions in SimBiology Models” on page 2-8
- “Definitions and Evaluations of Rules in SimBiology Models” on page 2-13
- “Events in SimBiology Models” on page 2-22
- “Variants in SimBiology Models” on page 2-29
- “Doses in SimBiology Models” on page 2-30
- “Simulate Biological Variability of the Yeast G Protein Cycle Using the Wild-Type and Mutant Strains” on page 2-33
- “Create and Simulate a Model with a Custom Function” on page 2-35
- “Component Usage” on page 2-41
- “Evaluation of Model Component Names in Expressions” on page 2-44
- “SimBiology Model Matching Policy” on page 2-46
- “Compare SimBiology Models” on page 2-48

What is a SimBiology Model?

In this section...

“Model Definition” on page 2-2

“Expressions” on page 2-2

“Quantities” on page 2-3

“Model Hierarchy” on page 2-4

“Representing a Model” on page 2-4

Model Definition

A SimBiology model is composed of a set of expressions (reactions, differential equations, discrete events), which together describe the dynamics of a biological system. You write expressions in terms of quantities (compartments, species, parameters), which are also enumerated in the model.

Expressions

There are four distinct types of expressions in SimBiology:

- Reactions
- Rules
- Events
- Observables

Reactions

A reaction describes a process such as a transformation, transport, or binding/unbinding process between reactants and products.

Example reactions include:

```
Creatine + ATP <-> ADP + phosphocreatine
cytoplasm.speciesA -> nucleus.speciesA
```

Rules

A rule is a class of mathematical expressions that include differential equations, initial assignments, repeated assignments, and algebraic constraints.

For example, you can use a rule to:

- Specify values for model components that are required for comparison with experimental data. For example, specify the active fraction of total protein.
- Assign values to model components based on the values of other components in the model. For example, define a parameter's value as being proportional to a species or another parameter.
- Define mass balance equations.
- For species, use rate rules as an alternative to the differential rate expression generated from reactions.

Events

An event describes an instantaneous change in the value of a quantity (compartment, species, parameter). The discrete transition occurs when a user-specified condition becomes true. The condition can be a specific time or a specific time-independent condition.

For example, you can use an event to:

- Activate or deactivate a specific species (activator or inhibitor species).
- Change a parameter value based on external signals.
- Change reaction rates in response to addition or removal of a species.
- Replicate an experimental condition, such as the addition or removal of an activating agent (such as a drug) to or from a sample.

Observable

An `Observable` is a mathematical expression that lets you perform post-simulation calculations. For example, you can use an observable to:

- Compute some statistics such as area under the curve (AUC) of a drug concentration profile.
- Compute the fraction of a ligand that is bound to a receptor at each time step.

You can also use an observable as a response in simulation, data fitting, and global sensitivity analysis.

Quantities

SimBiology uses three types of quantities in models:

- Compartments
- Species
- Parameters

Compartments

A compartment defines a physically bounded region that contains species. A compartment is characterized by a capacity expressed as volume, area, or length. A compartment can also contain other compartments, which adds hierarchy to a model. For example, a compartment named `cytoplasm` might contain a compartment named `nucleus`, thereby partitioning species based on their location.

Species

A species characterizes the state of the biological system by representing the amount (or concentration) present in the system for that entity. Examples of species are `DNA`, `ATP`, and `creatine`. Species' amounts (or concentrations) vary during a simulation as a result of their participation in reactions, differential equations, and events. Therefore, species represent the dynamical state of a biological system.

Parameters

A parameter is a quantity that is referred to by expressions. It typically remains constant during a simulation. For example, parameters are used as rate constants in reactions.

You can configure a parameter to vary during a simulation. This is useful, for example, to model the change in a reaction rate given the concentration of a catalyst or a change in temperature.

Model Hierarchy

Note the following conditions imposed on quantities in the model hierarchy:

- Models must contain at least one compartment.
- A compartment can contain one or more compartments.
- Species are always contained within a compartment.

Representing a Model

In SimBiology, models and their components are implemented as objects. These objects have properties and methods that you can use to access and configure them. Use the `get` method to list the property values of an object. Use the dot notation to change the property values of an object.

SimBiology objects are handle objects, which has implications for how they behave during copy operations. Handle objects are referenced by their handle variable, and copies of the handle variable refer to the same object. To learn how handle objects affect copy operations, see [Copying Objects](#).

See Also

`Model`

Species Object

A `species` object represents a species, which is the amount of a chemical or entity that participates in reactions. A species is always scoped to a compartment.

When adding species to a model with multiple compartments, you must specify qualified names, using `compartmentName.speciesName`. For example, `nucleus.DNA` denotes the species DNA in the compartment `nucleus`.

For information about...	See...
Creating and adding a species to a model	<code>addspecies</code>
Methods and properties of a species	<code>species</code> object

How Species Amounts Change During Simulations

The amount of a species can remain constant or vary during the simulation of a model. Use the following properties of a `species` object to specify how the amount of a species changes during a simulation:

- `ConstantAmount` property — When set to `true`, the species amount does not change during a simulation. The species can be part of a reaction or rule, but the reaction or rule cannot change its amount. When set to `false`, the species amount is determined by a reaction or a rule, but not both.
- `BoundaryCondition` property — When set to `true`, the species amount is either constant or determined by a rule, but not determined by a chemical reaction. In other words, the simulation does not create a differential rate term from the reactions for this species, even if it is in a reaction, but it can have a differential rate term created from a rule.

Keeping a Species Amount Unchanged

Set `ConstantAmount` to `true` and `BoundaryCondition` to `false` for a constant species, whose amount is not changed by a reaction or rule. In this case, the species acts like a parameter. It cannot be in a reaction, and it cannot be varied by a rule.

<code>ConstantAmount</code>	<code>BoundaryCondition</code>	<code>Reaction</code>	<code>Rule</code>	<code>Changed By</code>
<code>True</code>	<code>False</code>	<code>No</code>	<code>No</code>	<code>Never</code>

Example — Species `E` is not part of the reaction, but it is part of the reaction rate equation. `E` is constant and could be replaced with the constant $V_m = k_2 * E$.

```
reaction: S -> P
reaction rate: kcat*E*S/(Km + S)
```

Changing a Species Amount with a Reaction or Rule

Set `ConstantAmount` to `false` and `BoundaryCondition` to `false` for a species whose amount is changed by a reaction or rule, but not both.

ConstantAmount	BoundaryCondition	Reaction	Rule	Changed By
False	False	Yes	No	Reaction
False	False	No	Yes	Rule

Example 1 — Species **A** is part of a reaction, and it is in the reaction rate equation. The species amount or concentration is determined by the reaction. This is the most common category of a species. A differential rate equation for the species is created from the reactions.

```
reaction: A -> B
reaction rate: k*A
```

Example 2 — Species **E** is not part of the reaction, but it is in the reaction rate equation. **E** varies with another reaction or rule.

```
reaction: S -> P
reaction rate: kcat*E*S/(Km + S)
```

Example 3 — Species **G** is not part of a reaction, and it is not in a rate equation. **G** varies with an algebraic rule or rate rule.

```
rate rule: dG/dt = k
```

Changing a Species Amount with a Rule When Species is Part of a Reaction

Set ConstantAmount to false and BoundaryCondition to true for a species whose amount is changed by a rule, but the species is also part of a reaction, and a differential rate term from the reaction is not created. The amount of the species changes with the rule, and a differential rate term is created from the rule.

ConstantAmount	BoundaryCondition	Reaction	Rule	Changed By
False	True	Yes	Yes	Rule

Example 1 — Species **A** is not changed by the rate equation, but changes according to a rate rule. However, **A** could be in the rate equation that changes other species in the reaction.

```
reaction: A -> B
reaction rate: k1 or k1*A
rate rule: dA/dt = k2*A (solution is A = k2*t)
           (enter in SimBiology as A = k2*A)
```

Example 2 — Species **A** is not in the rate equation, but changes according to an algebraic rule.

```
reaction: A -> B + C
reaction rate: k or k*A
algebraic rule: A = 2*C
               (enter in SimBiology as 2*C - A)
```

Keeping a Species Amount Unchanged When Species is Part of a Reaction that Adds or Removes Mass

Set `ConstantAmount` to `false` and `BoundaryCondition` to `true` for a constant species that is part of a reaction, but a differential rate term is not created from the reaction. The differential rate term is created from a rule.

ConstantAmount	BoundaryCondition	Reaction	Rule	Changed By
True	True	Yes	No	Never

During simulation, a differential rate equation is not created for the species. $d\text{Species}/dt$ does not exist.

Example 1 — **A** is a *infinite source* and its amount does not change. **B** increases with a zero order rate (k and $k \cdot A$ are both constants). A source refers to a species where mass is added to the system.

```
reaction: A -> B
reaction rate: k or k*A
```

Example 2 — **B** decreases with a first-order rate, but **A** is an *infinite sink* and its amount does not change. A sink refers to a species where mass is subtracted from the system.

```
reaction: B -> A
reaction rate: k*B
```

Example 3 — The **null** species is a reserved species name that can act as a source or a sink.

```
reaction: null -> B
reaction rate: k
```

```
reaction: B -> null
reaction rate: k*B
```

Example 4 — **ATP** and **ADP** are in the reaction and have constant values, but they are not in the reaction rate equation.

```
reaction: S + ATP -> P + ADP
reaction rate: Vm*S/(Km + S)
```

Definitions and Evaluations of Reactions in SimBiology Models

A reaction is a mathematical expression that describe a transformation, transport, or binding process that changes one or more species. Typically, an amount of a species is changed through a reaction.

In SimBiology, a reaction is represented by a `reaction` object, which has the following properties.

- `Reaction` property — Mathematical expression that describes the reaction
- `ReactionRate` property — Mathematical expression that defines the rate at which the reactants combine to form products. You can provide this information explicitly or use the `KineticLaw` property to populate this information.
- `KineticLaw` property — Object that specifies a rate law that defines the type of reaction rate. Examples include Henri-Michaelis-Menten and Mass Action. The object also specifies `species` objects, or `parameter` objects. This property is optional. It serves as a template for a reaction rate and provides a convenient way of applying a specific rate law to multiple reactions. If you use this property, it automatically populates the `ReactionRate` property.

A reaction is scoped to a model.

For information about...	See...
Creating and adding a reaction to a model	<code>addreaction</code>
Methods and properties of a reaction	<code>reaction</code> object
Creating and adding a kinetic law to a reaction	<code>addkineticlaw</code>
Methods and properties of a kinetic law	<code>KineticLaw</code> object

Writing Reaction Expressions

Use standard chemistry reaction notation to create the mathematical expression for a reaction (`Reaction` property of a `reaction` object).

Following are rules for writing reaction expressions:

- Use spaces before and after species names and stoichiometric values.
- Stoichiometry values must be positive.
- If a stoichiometry value is not specified, it is assumed to be 1.
- In a model with a single compartment, specify species using `speciesName`. In a model with multiple compartments, specify species using qualified names: `compartmentName.speciesName`. For example, `nucleus.DNA` denotes the species DNA in the compartment nucleus.
- Enclose names with non-alphanumeric characters (including spaces) in brackets.
- Reactions can be reversible (`<->`) or irreversible (`->`).

Examples of reaction expressions include:

```

Creatine + ATP <-> ADP + phosphocreatine
glucose + 2 ADP + 2 Pi -> 2 lactic acid + 2 ATP + 2 H2O
cytoplasm.A -> nucleus.A
[compartment 1].[species A] -> [compartment 2].[species A]

```

Note Same species can be used multiple times in the list of reactions or products. The expression '2 A' is equivalent to 'A + A'.

Writing Reaction Rate Expressions Explicitly

Use any valid MATLAB code to create the mathematical expression for a reaction rate (`ReactionRate` property of a `reaction` object). The reaction rate can specify compartments, species, or parameters.

Following are rules for writing reaction rate expressions:

- The expression must be a single MATLAB statement that returns a scalar.
- In a model with a single compartment, specify species using *speciesName*. In a model with multiple compartments, specify species using qualified names: *compartmentName.speciesName*. For example, `nucleus.DNA` denotes the species DNA in the compartment nucleus.
- Enclose names with non-alphanumeric characters (including spaces) in brackets.
- Do not end the reaction rate expression with any of the following:
 - Semicolon
 - Comma
 - Comment text preceded by %
 - Line continuations indicated by ...

For example, if you have the following reaction expression:

```
Creatine + ATP <-> ADP + phosphocreatine
```

and the reaction follows Mass Action kinetics, then the reaction rate expression would be:

```
K*Creatine*ATP - Krev*ADP*phosphocreatine
```

Tip If your reaction rate expression is not continuous and differentiable, see “Using Events to Address Discontinuities in Rule and Reaction Rate Expressions” on page 2-28 before simulating your model.

Creating Reaction Rate Expressions Using Kinetic Law Objects

A `KineticLaw` object is scoped to a reaction and specifies:

- A rate law that defines the type of reaction rate. Examples include Henri-Michaelis-Menten and Mass Action.
- species and parameters

A `KineticLaw` object serves as a template for a reaction rate and provides a convenient way of applying a specific rate law to multiple reactions. You can use this object to create a reaction rate, which populates the `ReactionRate` property of the `reaction` object.

For example, if you create a `KineticLaw` object that specifies Henri-Michaelis-Menten for the `KineticLawName`, species `S`, and parameters `Vm` and `Km`, the reaction rate law is:

$$V_m * S / (K_m + S)$$

Then if you create a `reaction` object that specifies the previous `KineticLaw` object and species the following reaction expression:

A -> B

with $V_m = V_a$ and $K_m = K_a$ and $S = A$, then the reaction rate equation is:

$$V_a * A / (K_a + A)$$

Examples of Creating Reaction Rates

Example of Creating a Zero-Order Reaction

With a zero-order reaction, the reaction rate does not depend on the concentration of reactants. Examples of zero-order reactions are synthesis from a null species, and modeling a source species that is added to the system at a specified rate.

```

reaction: null -> P
reaction rate: k mole/second
species: P = 0 mole
parameters: k = 1 mole/second

```

Note When specifying a null species, the reaction rate must be defined in units of amount per unit time not concentration per unit time.

Entering the reaction above into the software and simulating produces the following result:

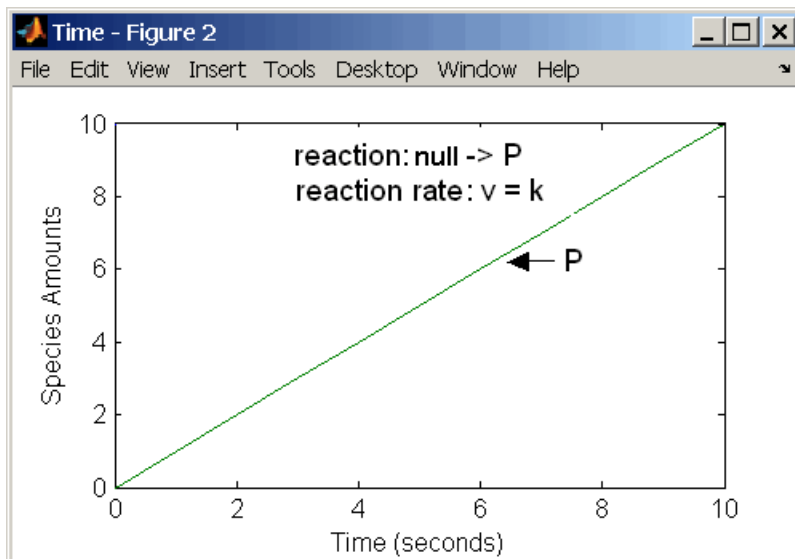

Zero-Order Mass Action Kinetics

Note If the amount of a reactant with zero-order kinetics reaches zero before the end of a simulation, then the amount of reactant can go below zero regardless of the solver or tolerances you set.

Examples of Creating Other Reactions

For examples of creating other reaction rates, see “Define Reaction Rates with Mass Action Kinetics” on page A-2 and “Define Reaction Rates with Enzyme Kinetics” on page A-6.

How Reaction Rates Are Evaluated

Reaction Rate Dimensions

When calculating species fluxes, SimBiology must determine whether you specified reaction rates in dimensions of amount/time or concentration/time. When all compartments in a model have a capacity of one unit, amount and concentration are numerically equivalent.

For all other models, the numerical results of the simulation depend on which interpretation SimBiology selects. SimBiology determines whether a reaction rate is in dimensions of amount/time or concentration/time via dimensional analysis of `ReactionRate` expressions. This minimum level of dimensional analysis always occurs, even when `DimensionalAnalysis` and `UnitConversion` are off.

The `DefaultSpeciesDimension` property defines the dimensions of species appearing in a reaction rate. SimBiology infers the dimensions of parameters appearing in a reaction rate from their `ValueUnits` property. If any parameters appearing in a reaction rate expression do not have units, SimBiology interprets the reaction rate in dimensions of amount/time. Therefore, the only way to specify that a reaction rate has dimensions of concentration/time is to assign appropriate units to all parameters.

Reactions Spanning Multiple Compartments

Specify reactions that span compartments using the syntax `compartment1Name.species1Name -> compartment2Name.species2Name`. The reaction rate dimensions must resolve to amount/time if either of the following conditions are true:

- Reactant species are in different compartments.
- The reaction is reversible mass action and the products are in multiple compartments.

Note The `MassAction` and `Unknown` kinetic laws can have different simulation results even when the reaction rate is the same. This can happen when you have a reversible reaction with species in different compartments. The difference in simulation results is because of the volume-scaling performed by SimBiology during the dimensional analysis. For details, see “Deriving ODEs from Reactions” on page 4-5. Specifically, for `MassAction`, SimBiology uses corresponding compartment volumes to multiply the forward and reverse rates. However, for `Unknown` and other built-in kinetic laws, SimBiology multiplies the entire rate by only one compartment which contains the reactants. To see exactly what compartment volumes are used for scaling, use `getequations` or open the **Equations** view from the **SimBiology** app and check the ODEs section.

Examples

Consider a reaction $a + b \rightarrow c$. Using mass action kinetics, the reaction rate is $k \cdot a \cdot b$, where k is the rate constant of the reaction. If you specify that initial amounts of a and b are 0.01 molarity and 0.005 molarity respectively, then the reaction rate is in concentration/time (and units of molarity/second) if the units of k are $1/(\text{molarity} \cdot \text{second})$. If you specify k with another equivalent unit definition, for example, $1/((\text{moles/liter}) \cdot \text{second})$, SimBiology checks whether the physical quantities match. If the physical quantities do not match, you see an error and the model is not simulated.

If, in the previous example, you specify that initial amounts of a and b are 0.01 and 0.005 respectively, without specifying units, SimBiology checks whether `DefaultSpeciesDimension` is substance or concentration. If `DefaultSpeciesDimension` is concentration, and you set units on the rate constant such that the reaction rate dimensions resolve to concentration/time, SimBiology scales the species amounts for compartment capacity, and returns the species values in concentration.

If you specify initial amounts of a and b as 0.01 molarity and 0.005 mole respectively, include the volume scaling for b in the reaction rate expression. Include volume scaling in the rate constant, and set the units of the rate constant accordingly ($1/(\text{mole} \cdot \text{second})$ for concentration/time, or $1/(\text{molarity} \cdot \text{second})$ for amount/time).

Viewing Equations for Reactions

You can view the system of equations that SimBiology creates when you build a model using reaction expressions. For details, see “View Model Equations” on page 3-3.

See Also

More About

- “Create and Simulate a Model with a Custom Function” on page 2-35
- “Model Simulation” on page 4-3
- “Deriving ODEs from Reactions” on page 4-5
- “What is a SimBiology Model?” on page 2-2
- “Definitions and Evaluations of Rules in SimBiology Models” on page 2-13
- “Events in SimBiology Models” on page 2-22
- “Component Usage” on page 2-41
- “Evaluation of Model Component Names in Expressions” on page 2-44

Definitions and Evaluations of Rules in SimBiology Models

In this section...

“Overview” on page 2-13

“Initial Assignment” on page 2-13

“Repeated Assignment” on page 2-13

“Algebraic Rules” on page 2-14

“Repeated Assignment vs. Algebraic Rules” on page 2-14

“Rate Rules” on page 2-14

“Evaluation Order of Rules” on page 2-15

“Conservation of Amounts During Simulation” on page 2-15

“Writing Rule Expressions” on page 2-16

“Considerations When Imposing Constraints” on page 2-16

“Rate Rule Examples” on page 2-16

Overview

Rules are mathematical expressions that allow you to define or modify model quantities, namely compartment capacity, species amount, or parameter value.

Rules can take the form of initial assignments, assignments during the course of a simulation (repeated assignments), algebraic relationships, or differential equations (rate rules). Details of each type of rule are described next.

Initial Assignment

An initial assignment rule lets you specify the initial value of a model quantity as a numeric value or as a function of other model quantities. It is evaluated once at the beginning of a simulation.

An initial assignment rule is expressed as `Variable = Expression`, and the rule is specified as the `Expression`. For example, you could write an initial assignment rule to set the initial amount of `species2` to be proportional to `species1` as `species2 = k * species1` where `k` is a constant parameter.

Repeated Assignment

A repeated assignment rule lets you specify the value of a quantity as a numeric value or as a function of other quantities repeatedly during the simulation. It is evaluated at every time step, which is determined by the solver during the simulation process.

A repeated assignment rule is expressed as `Variable = Expression`, and the rule is specified as the `Expression`. For example, to repeatedly evaluate the total species amount by summing up the species in different compartments, you could enter: `xTotal = c1.X + c2.X`, where `xTotal` is a nonconstant parameter, `c1` and `c2` are the name of compartments where species `x` resides.

Algebraic Rules

An algebraic rule lets you specify mathematical constraints on one or more model quantities that must hold during a simulation. It is evaluated continuously during a simulation.

An algebraic rule takes the form $0 = \text{Expression}$, and the rule is specified as the `Expression`. For example, if you have a mass conservation equation such as `species_total = species1 + species2`, write the corresponding algebraic rule as `species1 + species2 - species_total`.

However, repeated assignment rules are mathematically equivalent to algebraic rules, but result in exact solutions instead of approximated solutions. Therefore, it is recommended that you use repeated assignment rules instead of algebraic rules whenever possible. Use algebraic rules only when:

- You cannot analytically solve the equations to get a closed-form solution. For example, there is no closed-form solution for $x^4 + ax^3 + bx^2 + cx + k = 0$ whereas the closed-form solution for $kx - c = 0$ is $x = c/k$.
- You have multiple equations with multiple unknowns, and they could be inconvenient to solve.

If you use an algebraic rule, rate rule, or repeated assignment to vary the value of a parameter or compartment during the simulation, make sure the `ConstantValue` property of the parameter or `ConstantCapacity` of the compartment is set to `false`.

Repeated Assignment vs. Algebraic Rules

Repeated assignment rules are mathematically equivalent to algebraic rules, but result in exact solutions. However, algebraic rules are solved numerically, and the accuracy depends on the error tolerances specified in the simulation settings. In addition, there are several advantages to repeated assignment rules such as better computational performance, more accurate results since no rules have to be solved numerically (hence no approximations), and sensitivity analysis support.

Tip

- If you can analytically solve for a variable, use a repeated assignment rule instead of an algebraic rule.
 - In repeated assignment rules, the constrained variable is explicitly defined as the left-hand side, whereas in algebraic rules it is inferred from the degrees of freedom in the system of equations. See also “Considerations When Imposing Constraints” on page 2-16.
-

Rate Rules

A rate rule represents a differential equation and lets you specify the time derivative of a model quantity. It is evaluated continuously during a simulation.

A rate rule is represented as $\frac{d\text{Variable}}{dt} = \text{Expression}$, which is expressed in SimBiology as `Variable = Expression`. For example, if you have a differential equation for species x , $\frac{dx}{dt} = k(y + z)$, write the rate rule as: `x = k * (y + z)`.

For more examples, see “Rate Rule Examples” on page 2-16.

Evaluation Order of Rules

At the start of the simulation (that is, at simulation time = 0), SimBiology evaluates the initial assignment and repeated assignment rules as a set of simultaneous constraints. SimBiology treats the rules as a unified system of constraints and automatically reorders and evaluates them. The order in which the rules appear in the model has no effect on the simulation results.

If a quantity is being modified by an assignment rule, the rule replaces initial value properties, such as `InitialAmount`, `Capacity`, or `Value`. Similarly, a variant altering such quantities has no effect because the value is superseded by the assignment rules.

SimBiology throws an error if the model has circular dependencies in the initial assignment and repeated assignment rules. In other words, initial assignments and repeated assignments cannot have a variable that is explicitly or implicitly referenced on both the left- and right-hand sides of the equation.

For instance, you cannot create circular sets of assignments such as $a = b + 1$ and $b = a + 1$, where a and b are explicitly referenced on both sides of the equation. An example of an implicit reference is when an assignment rule references a species in concentration. In this case, the compartment that contains the species is implicitly referenced.

Warning You might observe different simulation results with respect to initial assignments for previous releases of SimBiology (R2017a or earlier). To recover the same simulation results at time = 0, as in R2017a or earlier, use the `updateInitialAssignments` function in the command line. If you are using the **SimBiology** app, right-click the model from the **Project Workspace** and select **Remove Order Dependencies**.

Conservation of Amounts During Simulation

During a simulation (that is, at simulation time > 0), SimBiology conserves species amounts rather than concentrations if there are any changes to the volume of a compartment where the species reside. In other words, if you have a repeated assignment rule or an event that changes the volume, then you see the effect of conservation of species amounts at time > 0.

However, at the beginning of a simulation (that is, at simulation time = 0), the concept of amount conservation does not apply because there are no changes before time = 0. Only one set of initial conditions exists and SimBiology uses the conditions at the start of the simulation. Specifically, at time = 0, SimBiology:

- 1 Initializes variables for species, compartments, and parameters using the corresponding `InitialAmount`, `Capacity`, and `Value` properties.
- 2 Updates the values by replacing them with the corresponding alternate values from variants, if any.
- 3 Updates the values by evaluating initial assignment and repeated assignment rules as a set of simultaneous constraints. Therefore, the assignment rules replace initial values if model quantities are being modified by such rules or variants.

Warning In previous releases (R2017a or earlier), if a repeated assignment changed a compartment volume, SimBiology used the compartment capacity to determine the initial amount and conserved it when the compartment volume changed at time = 0. In R2017b or later, SimBiology uses the

`InitialAmount` property of the species as the initial condition at time = 0. Consider the following model.

```
m = sbiomodel('m1')
v = addcompartment(m, 'v', 10, 'ConstantCapacity', 0, 'CapacityUnit', 'liter')
p = addparameter(m, 'p', 'ValueUnit', 'liter')
r = addrule(m, 'v = 100 * p', 'repeatedAssignment')
s = addspecies(v, 's', 50, 'InitialAmountUnit', 'milligram/liter')
```

In R2017a or earlier, SimBiology first calculated the initial amount of *s* as 50 milligram/liter * 10 liter = 500 milligram, and then applied the repeated assignment rule $v = 100$ liter. So, the concentration of *s* was then calculated and reported as 500 milligram/100 liter = 5 milligram/liter at time = 0.

In R2017b or later, SimBiology uses the `InitialAmount` property of species *s*, and reports the initial amount of *s* as 50 milligram/liter instead.

Writing Rule Expressions

Use MATLAB syntax to write a mathematical expression for a rule. Note that no semicolon or comma is needed at the end of a rule expression. If your algebraic, repeated assignment, or rate rule expression is not continuous or differentiable, see “Using Events to Address Discontinuities in Rule and Reaction Rate Expressions” on page 2-28 before simulating your model.

Considerations When Imposing Constraints

Suppose that you have a species *y* whose amount is determined by the equation $y = m * x - c$. In SimBiology, the algebraic rule to describe this constraint is written as $m * x - c - y$. If you want to use this rule to determine the value of *y*, then *m*, *x*, and *c* must be variables or constants whose values are known or determined by other equations. Therefore, you must ensure that the system of equations is not overconstrained or underconstrained. For instance, if you have more equations than unknowns, then the system is overconstrained. Conversely, if you have more unknowns than the equations, then the system is underconstrained.

Tip The behavior of an underconstrained system could be fixed by adding additional rules or by setting the `ConstantValue` or `ConstantCapacity` or `ConstantAmount` property of some of the components in the model.

Rate Rule Examples

The following examples show how to create rate rules for different applications.

Create a Rate Rule for a Constant Rate of Change

This example shows how to increase the amount or concentration of a species by a constant value using the zero-order rate rule. For example, suppose species *x* increases by a constant rate *k*. The rate of change is:

$$dx/dt = k$$

Set the initial amount of species *x* to 2, and the value of parameter *k* to 1. Use the following commands to set up a SimBiology model accordingly and simulate it.

```

m = sbiomodel('m');
c = addcompartment(m,'comp');
s = addspecies(m,'x','InitialAmount',2);
p = addparameter(m,'k','Value',1);
r = addrule(m,'x = k','RuleType','rate');
[t,sd,species] = sbiosimulate(m);
plot(t,sd);
legend(species)
xlabel('Time');
ylabel('Species Amount');

```

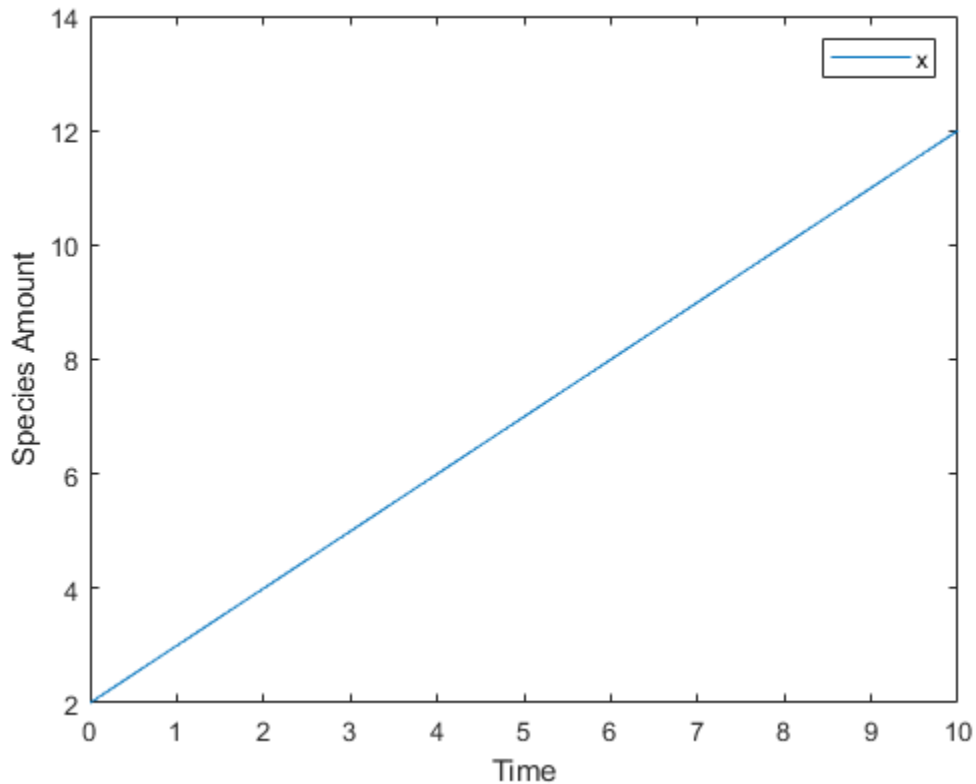

Alternatively, you could model a constant increase in a species using the Mass Action reaction $\text{null} \rightarrow x$ with the forward rate constant k .

```

clear
m = sbiomodel('m');
c = addcompartment(m,'comp');
s = addspecies(m,'x','InitialAmount',2);
r = addreaction(m,'null -> x');
kl = addkineticlaw(r,'MassAction');
p = addparameter(kl,'k','Value',1);
kl.ParameterVariableNames = 'k';
[t,sd,species] = sbiosimulate(m);
plot(t,sd);
legend(species)
xlabel('Time');
ylabel('Species Amount');

```

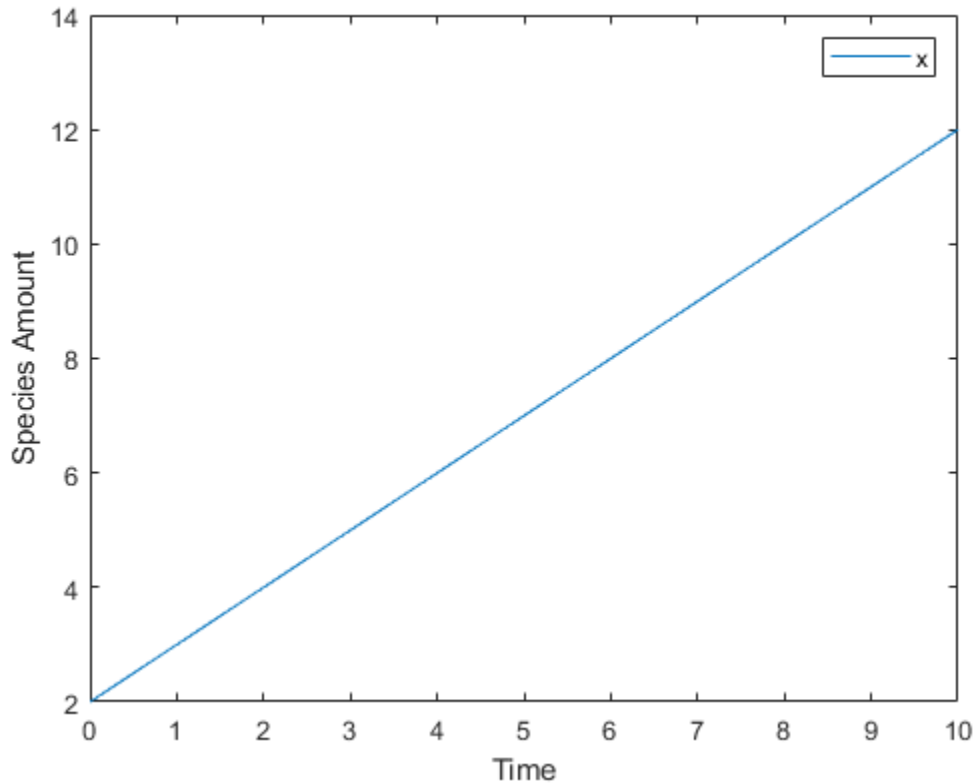

Create a Rate Rule for an Exponential Rate of Change

This example shows how to change the amount of a species similar to a first-order reaction using the first-order rate rule. For example, suppose the species x decays exponentially. The rate of change of species x is:

$$dx/dt = -k * x$$

The analytical solution is:

$$C_t = C_0 * e^{-kt}$$

where C_t is the amount of species at time t , and C_0 is the initial amount. Use the following commands to set up a SimBiology model accordingly and simulate it.

```
m = sbiomodel('m');
c = addcompartment(m,'comp');
s = addspecies(m,'x','InitialAmount',2);
p = addparameter(m,'k','Value',1);
r = addrule(m,'x = -k * x','RuleType','rate');
[t,sd,species] = sbiosimulate(m);
plot(t,sd);
legend(species);
xlabel('Time');
ylabel('Species Amount');
```

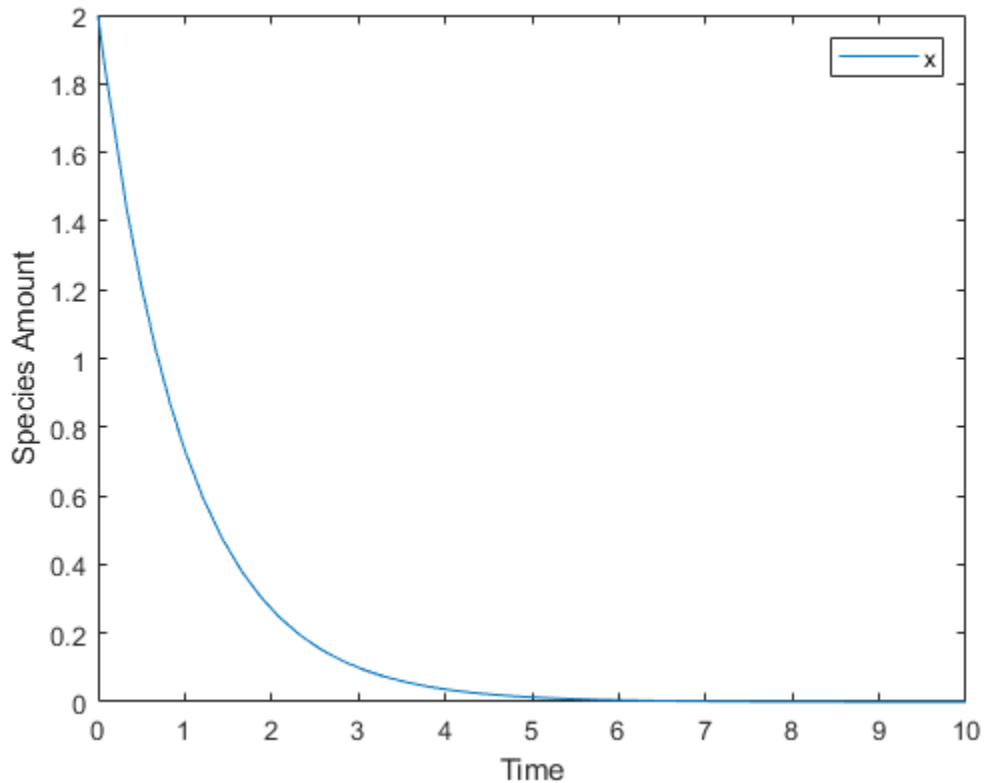

If the amount of a species x is determined by a rate rule and x is also in a reaction, x must have its `BoundaryCondition` property set to `true`. For example, with a reaction $a \rightarrow x$ and a rate rule $\frac{dx}{dt} = k * x$, set the `BoundaryCondition` property of species x to `true` so that a differential rate term is not created from the reaction. The amount of x is determined solely by a differential rate term from the rate rule. If the `BoundaryCondition` property is set to `false`, you will get the following error message such as `Invalid rule variable 'x' in rate rule or reaction`.

Create a Rate Rule to Define a Differential Rate Equation

Many mathematical models in the literature are described with differential rate equations for the species. You could manually convert the equations to reactions, or you could enter the equations as rate rules. For example, you could enter the following differential rate equation for a species C :

$$\frac{dC}{dt} = v_i - v_d X \frac{C}{K_C + C} - k_d * C$$

as a rate rule in SimBiology: `C = v_i - (v_d*X*C)/(Kc + C) - kd*C`

Create a Rate Rule for the Rate of Change That Is Determined by Another Species

This example shows how to create a rate rule where a species from one reaction can determine the rate of another reaction if it is in the second reaction rate equation. Similarly, a species from a reaction can determine the rate of another species if it is in the rate rule that defines that other species. Suppose you have a SimBiology model with three species (a , b , and c), one reaction ($a \rightarrow$

b), and two parameters (k_1 and k_2). The rate equation is defined as $b = -k_1 * a$, and rate rule is $dc/dt = k_2 * a$. The solution for the species in the reaction are:

$$a = a_0 e^{-k_1 t}, b = a_0 (1 - e^{-k_1 t}).$$

Since the rate rule $dc/dt = k_2 * a$ is dependent on the reaction, $dc/dt = k_2 (a_0 e^{-k_1 t})$. The solution is:

$$c = c_0 + k_2 a_0 / k_1 (1 - e^{-k_1 t})$$

Enter the following commands to set up a SimBiology model accordingly and simulate it.

```
m = sbiomodel('m');
c = addcompartment(m, 'comp');
s1 = addspecies(m, 'a', 'InitialAmount', 10, 'InitialAmountUnits', 'mole');
s2 = addspecies(m, 'b', 'InitialAmount', 0, 'InitialAmountUnits', 'mole');
s3 = addspecies(m, 'c', 'InitialAmount', 5, 'InitialAmountUnits', 'mole');
rxn = addreaction(m, 'a -> b');
kl = addkineticlaw(rxn, 'MassAction');
p1 = addparameter(kl, 'k1', 'Value', 1, 'ValueUnits', '1/second');
rule = addrule(m, 'c = k2 * a', 'RuleType', 'rate');
kl.ParameterVariableNames = 'k1';
p2 = addparameter(m, 'k2', 'Value', 1, 'ValueUnits', '1/second');
[t, sd, species] = sbiosimulate(m);
plot(t, sd);
legend(species);
xlabel('Time');
ylabel('Species Amount');
```

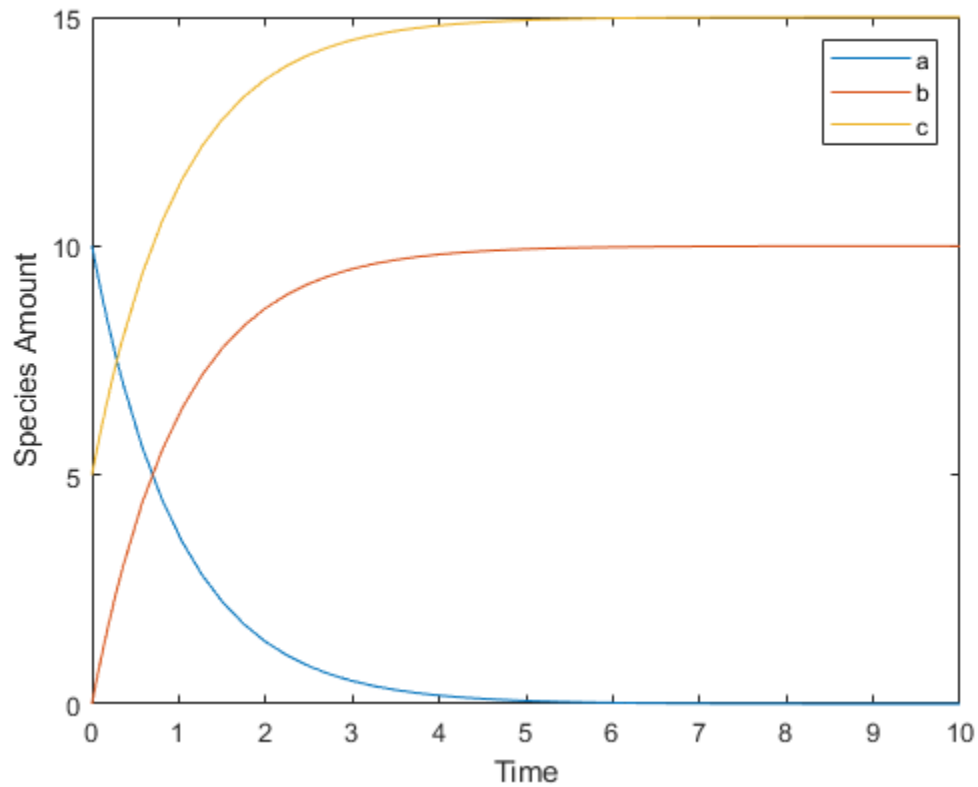

See Also

More About

- “What is a SimBiology Model?” on page 2-2
- “Definitions and Evaluations of Reactions in SimBiology Models” on page 2-8
- “Events in SimBiology Models” on page 2-22
- “Component Usage” on page 2-41
- “Evaluation of Model Component Names in Expressions” on page 2-44

Events in SimBiology Models

In this section...

“Overview” on page 2-22

“Event Triggers” on page 2-22

“Event Functions” on page 2-22

“Specifying Event Triggers” on page 2-23

“Specifying Event Functions” on page 2-24

“Simulation Solvers for Models Containing Events” on page 2-25

“How Events Are Evaluated” on page 2-25

“Evaluation of Simultaneous Events” on page 2-26

“Evaluation of Multiple Event Functions” on page 2-27

“When One Event Triggers Another Event” on page 2-27

“Cyclical Events” on page 2-27

“Using Events to Address Discontinuities in Rule and Reaction Rate Expressions” on page 2-28

Overview

In SimBiology, an event is a discrete transition in value of a quantity or expression in a model. This discrete transition occurs when a customized condition becomes true. The condition can be a specific time and/or a time-independent condition. Such conditions are defined in an `Event` object.

Event Triggers

An event object has a `Trigger` property that specifies a condition that must be true to trigger the event to execute.

Typical event triggers are:

- A specific simulation time — Specify that the event must change the amounts or values of species or parameters. For example, at time = 5 s, increase the amount of an inhibitor species above the threshold to inhibit a given reaction.
- In response to state or changes in the system — Change amounts/values of certain species/parameters in response to events that are not tied to any specific time. For example, when species A reaches an amount of 30 molecules, double the value of reaction rate constant k. Or when temperature reaches 42 °C, inhibit a particular reaction by setting its reaction rate to zero.

Note Currently, events cannot be triggered at time = 0. However, you can get the event to happen just after time = 0 by using `time > timeSmall` as the event trigger where `timeSmall` can be a tiny fraction of a second such as 1.0 picosecond.

Event Functions

An event has an `EventFcns` property that specifies what occurs when the event is triggered. Event functions can range from simple to complex. For example, an event function might:

- Change the values of compartments, species, or parameters.
- Double the value of a reaction rate constant.

Specifying Event Triggers

The `Trigger` property of an event specifies a condition that must become true for an event to execute. Typically, the condition uses a combination of relational and logical operators to build a trigger expression.

A trigger can contain the keyword `time` and relational operators to trigger an event that occurs at a specific time during the simulation. For example, `time >= x`. For more information see the `Trigger` property.

Use MATLAB syntax to write expressions for event triggers. Note that the expression must be a single MATLAB statement that returns a logical. No semicolon or comma is needed at the end of an expression. MATLAB uses specific operator precedence to evaluate trigger expressions. Precedence levels determine the order in which MATLAB evaluates an expression. Within each precedence level, operators have equal precedence and are evaluated from left to right. To find more information on how relational and logical operators are evaluated see “Relational Operations” and “Logical (Boolean) Operations”.

Some examples of triggers are:

Trigger	Explanation
<code>(time >= 5) && (speciesA < 1000)</code>	<p>Execute the event when the following condition becomes true:</p> <p>Time is greater than or equal to 5, and <code>speciesA</code> is less than 1000.</p> <hr/> <p>Tip Using a <code>&&</code> (instead of <code>&</code>) evaluates the first part of the expression for whether the statement is true or false, and skips evaluating the second statement if this statement is false.</p>
<code>(time >= 5) (speciesA < 1000)</code>	<p>Execute the event when the following condition becomes true:</p> <p>Time is greater than or equal to 5, or if <code>speciesA</code> is less than 1000.</p>

Trigger	Explanation
<code>(s1 >= 10.0) (time >= 250) && (s2 < 5.0E17)</code>	<p>Execute the event when the following condition becomes true:</p> <p>Species, <code>s1</code> is greater than or equal to <code>10.0</code> or, time is greater than or equal to <code>250</code> and species <code>s2</code> is less than <code>5.0E17</code>.</p> <p>Because of operator precedence, the expression is treated as if it were <code>(s1 >=10.0) ((time>= 250) && (s2<5.0E17))</code>.</p> <p>Thus, it is always a good idea to use parenthesis to explicitly specify the intended precedence of the statements.</p>
<code>((s1 >= 10.0) (time >= 250)) && (s2 < 5.0E17)</code>	<p>Execute the event when the following condition becomes true:</p> <p>Species <code>s1</code> is greater than or equal to <code>10</code> or time is greater than or equal to <code>250</code>, and species <code>s2</code> is less than <code>5.0E17</code>.</p>
<code>((s1 >= 5000.0) && (time >= 250)) (s2 < 5.0E17)</code>	<p>Execute the event when the following condition becomes true:</p> <p>Species <code>s1</code> is greater than or equal to <code>5000</code> and time is greater than or equal to <code>250</code>, or species <code>s2</code> is less than <code>5.0E17</code>.</p>

Tip If UnitConversion is on and your model has any event, follow the recommendation below.

Non-dimensionalize any parameters used in the event Trigger if they are not already dimensionless. For example, suppose you have a trigger `x > 1`, where `x` is the species concentration in mole/liter. Non-dimensionalize `x` by scaling (dividing) it with a constant such as `x/x0 > 1`, where `x0` is a parameter defined as 1.0 mole/liter. Note that `x` does not have to have the same unit as the constant `x0`, but must be dimensionally consistent with it. For example, the unit of `x` can be picomole/liter instead of mole/liter.

Specifying Event Functions

The EventFcns property of an event specifies what occurs when the event is triggered. You can use an event function to change the value of a compartment, species, or parameter, or you can specify complex tasks by calling a custom function or script.

Use MATLAB syntax to define expressions for event functions. The expression must be a single MATLAB assignment statement that includes `=`, or a cell array of such statements. No semicolon or comma is needed at the end of the expression.

Following are rules for writing expressions for event functions:

EventFcn	Explanation
<code>speciesA = speciesB</code>	When the event is executed, set the amount of <code>speciesA</code> equal to that of <code>speciesB</code> .
<code>k = k/2</code>	When the event is executed, halve the value of the rate constant <code>k</code> .
<code>{'speciesA = speciesB', 'k = k/2'}</code>	When the event is executed, set the amount of <code>speciesA</code> equal to that of <code>speciesB</code> , and halve the value of the rate constant <code>k</code> .
<code>kC = my_func(A,B,kC)</code>	When the event is executed, call the custom function <code>my_func()</code> . This function takes three arguments: The first two arguments are the current amounts of two species (<code>A</code> and <code>B</code>) during simulation and the third argument is the current value of a parameter, <code>kC</code> . The function returns the modified value of <code>kC</code> as its output.

Simulation Solvers for Models Containing Events

To simulate models containing events, use a deterministic (ODE or SUNDIALS) solver or the stochastic `ssa` solver. Other stochastic solvers do not support events. For more information, see “Choosing a Simulation Solver” on page 4-7.

How Events Are Evaluated

Consider the example of a simple event where you specify that at 4s, you want to assign a value of 10 to species A.

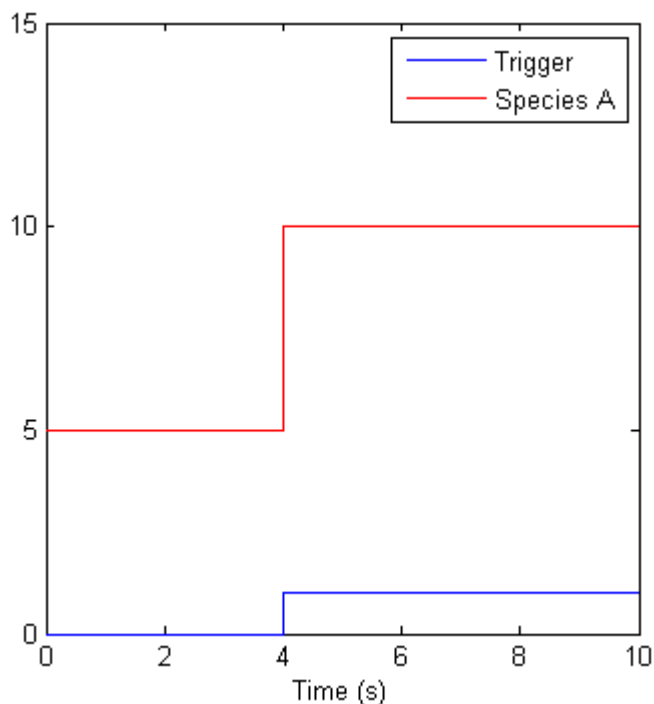

At $\text{time} = 4 \text{ s}$ the trigger becomes true and the event executes. In the previous figure assuming that 0 is false and 1 is true, when the trigger becomes true, the amount of species A is set to 10. In theory, with a perfect solver, the event would be executed exactly at $\text{time} = 4.00 \text{ s}$. In practice there is a very minute delay (for example you might notice that the event is executed at $\text{time} = 4.00001 \text{ s}$). Thus, you must specify that the trigger can become true at or after 4s, which is $\text{time} \geq 4 \text{ s}$.

Trigger	EventFcn
$\text{time} \geq 4$	$A = 10$

The point at which the trigger becomes true is called a rising edge. SimBiology events execute the `EventFcn` *only* at rising edges.

The trigger is evaluated at every time step to check whether the condition specified in the trigger transitions from false to true. The solver detects and tracks falling edges, which is when the trigger becomes false, so if another rising edge is encountered, the event is reexecuted. If a trigger is already true before a simulation starts, then the event does not execute at the start of the simulation. The event is not executed until the solver encounters a rising edge. Very rarely, the solver might miss a rising edge. An example of this is when a rising edge follows very quickly after a falling edge, and the step size results in the solver skipping the transition point.

If the trigger becomes true exactly at the stop time of the simulation, the event might or might not execute. If you want the event to execute, increase the stop time.

Note Since the rising edge is instantaneous and changes the system state, there are two values for the state at the same time. The simulation data thus contains the state before and after the event, but both points are at the same time value. This leads to multiple values of the system state at a single instant in time.

Evaluation of Simultaneous Events

When two or more trigger conditions simultaneously become true, the solver executes the events sequentially in the order in which they are listed in the model. You can reorder events using the `reorder` method. For example, consider this case.

Event Number	Trigger	EventFcn
1	$\text{SpeciesA} \geq 4$	$\text{SpeciesB} = 10$
2	$\text{SpeciesC} \geq 15$	$\text{SpeciesB} = 25$

The solver tries to find the rising edge for these events within a certain level of tolerance. If this results in both events occurring simultaneously, then the value of `SpeciesB` after the time step in which these two events occur, will be 25. If you reorder the events to reverse the event order, then the value of `SpeciesB` after the time step in which these two events occur, will be 10.

Consider an example in which you include event functions that change model components in a dependent fashion. For example, the event function in Event 2, stipulates that `SpeciesB` takes the value of `SpeciesC`.

Event Number	Trigger	EventFcn
1	SpeciesA >= 4	SpeciesC = 10
2	time >= 15	SpeciesB = SpeciesC

Event 1 and Event 2 might or might not occur simultaneously.

- If Event 1 and Event 2 do not occur simultaneously, when Event 2 is triggered, SpeciesB is assigned the value that SpeciesC has at the time of the event trigger.
- If Event 1 and Event 2 occur simultaneously, the solver executes Event 1 first, then executes Event 2. In this example, if SpeciesC = 15 when the events are triggered, after the events are executed, SpeciesC = 10 and SpeciesB = 10.

Evaluation of Multiple Event Functions

Consider an event function in which you specify that the value of a model component (SpeciesB) depends on the value of model component (SpeciesA), but SpeciesA also is changed by the event function.

Trigger	EventFcn
time >= 4	{'SpeciesA = 10, SpeciesB = SpeciesA'}

The solver stores the value of SpeciesA at the rising edge and before any event functions are executed and uses this stored value to assign SpeciesB its value. So in this example if SpeciesA = 15 at the time the event is triggered, after the event is executed, SpeciesA = 10 and SpeciesB = 15.

When One Event Triggers Another Event

In the next example, Event 1 includes an expression in the event function that causes Event 2 to be triggered (assuming that SpeciesA has amount less than 5 when Event 1 is executed).

Event Number	Trigger	EventFcn
1	time >= 5	{'SpeciesA = 10, SpeciesB = 5'}
2	SpeciesA >= 5	SpeciesC = SpeciesB

When Event 1 is triggered, the solver evaluates and executes Event 1 with the result that SpeciesA = 10 and SpeciesB = 5. Now, the trigger for Event 2 becomes true and the solver executes the event function for Event 2. Thus, SpeciesC = 5 at the end of this event execution.

You can thus have event cascades of arbitrary length, for example, Event 1 triggers Event 2, which in turn triggers Event 3, and so on.

Cyclical Events

In some situations, a series of events can trigger a cascade that becomes cyclical. Once you trigger a cyclical set of events, the only way to stop the simulation is by pressing **Ctrl+C**. You lose any data acquired in the current simulation. Here is an example of cyclical events. This example assumes that Species B <= 4 at the start of the cycle.

Event Number	Trigger	EventFcn
1	SpeciesA > 10	{'SpeciesB = 5', 'SpeciesC = 1'}
2	SpeciesB > 4	{'SpeciesC = 10', 'SpeciesA = 1'}
3	SpeciesC > 9	{'SpeciesA = 15', 'SpeciesB = 1'}

Using Events to Address Discontinuities in Rule and Reaction Rate Expressions

The solvers provided with SimBiology gives inaccurate results when the following expressions are not continuous and differentiable:

- Repeated assignment rule
- Algebraic rule
- Rate rule
- Reaction rate

Either ensure that the previous expressions are continuous and differentiable or use events to reset the solver at the discontinuity, as described in “Deterministic Simulation of a Model Containing a Discontinuity” on page 4-109.

See Also

More About

- “What is a SimBiology Model?” on page 2-2
- “Model Simulation” on page 4-3
- “Conservation of Amounts During Simulation” on page 2-15
- “Definitions and Evaluations of Reactions in SimBiology Models” on page 2-8
- “Definitions and Evaluations of Rules in SimBiology Models” on page 2-13
- “Component Usage” on page 2-41
- “Evaluation of Model Component Names in Expressions” on page 2-44

Variants in SimBiology Models

A variant stores alternate values of model parameters and initial conditions. You can use variants to evaluate model behavior under different experimental or initial conditions, without having to change the existing values or create additional models with the new values.

A variant lets you store an alternate value for any of the following model elements:

- `Compartment Capacity` property
- `Species InitialAmount` property
- `Parameter Value` property

Simulating using a variant does not alter the model original values. The values specified in the variant are temporarily applied to the model during simulation. You can permanently replace the values in your model with the values stored in the variant object by committing it to the model. When you use multiple variants during a simulation, and there are duplicate specifications for a property value, the last occurrence for the property value in the array of variants is used during simulation.

Creating Variants Programmatically

There are two ways to create variants or add variants to a model. To create a standalone variant that is not attached to any model, use `sbiovariant`. To add a variant to an existing model, use `addvariant`. Use the `commit` function to replace the values in your model with the variant values permanently.

For illustrated examples of using variants, see the following.

- “Simulate Biological Variability of the Yeast G Protein Cycle Using the Wild-Type and Mutant Strains” on page 2-33
- “Simulate Model of Glucose-Insulin Response with Different Initial Conditions” on page 3-18

Creating Variants Graphically

You can interactively create and add variants using the **SimBiology Model Builder** app. For details, see “Represent Biological Variability Using Variants” on page 1-28.

See Also

`Variant` object | `sbiovariant` | `addvariant` | `commit` | `addcontent`

More About

- “SimBiology Apps”
- “Represent Biological Variability Using Variants” on page 1-28

Doses in SimBiology Models

Doses let you increase the amount of a species in a SimBiology model during simulation, either at specific time points or regular intervals. For example, you can use a dose object to model an instantaneous supply of a drug regimen during the simulation of a model. The increase in the amount of a species occurs only during simulation and does not alter the species value permanently (that is, the value in the model is not changed).

Representing Doses

There are two types of dose objects.

- `ScheduleDose` object — Applies a dose to a single species at a predefined list of time points
- `RepeatDose` object — Applies a dose to a single species at regular intervals

SimBiology dose objects support the following dosing types.

Dosing Strategy	Description	Dose Object Properties Configuration
Bolus	Instantaneous increase in the amount of drug in the compartment	To create a bolus dose, set the <code>Amount</code> and <code>TargetName</code> properties of a dose object. You might also need to configure other properties such as <code>RepeatCount</code> , <code>Interval</code> , or scheduled dose times (<code>Time</code>) if you are applying a series of doses. For details on these properties, see <code>ScheduleDose</code> object and <code>RepeatDose</code> object.
Infusion	Increase of the drug at a fixed rate over a period of time, which is calculated from the dose amount	Unlike a bolus dose, you also need to specify the infusion rate (<code>Rate</code> property) of the dose object.
Zero-order	Increase of the drug at a fixed rate calculated from the dose amount and dose duration	Unlike a bolus dose, you also need to create a zero-order duration parameter and specify the duration parameter name (<code>DurationParameterName</code> property) of the dose object.
First-order	Increase of the drug via first-order absorption kinetics	Unlike bolus, infusion, or zero-order, you need to create an additional reaction for the drug absorption.

Creating Doses Programmatically

There are two common ways to create dose objects using the command-line interface. One way is to create a dose object using the `sbiodose` or `adddose` function. Another is to create dose objects automatically from data containing dosing information. This first approach is useful when you want to explore different dosing strategies through simulation. The second approach is useful if you already have a data set with dosing information and plan to use this dosing information in your simulation or parameter estimation.

Create a Dose Object Using `sbiodose` or `adddose`

`sbiodose` creates a standalone dose object that is not attached to any model. You can apply a standalone dose to different models during simulation by specifying it as a dosing argument for `sbiosimulate`, or attach it to any model using `adddose`. You can also use it during parameter estimation using `sbiofit` or `sbiofitmixed`.

`adddose` creates a dose object and adds it to a model. You must set its `Active` property to `true` to apply the dose to the model during simulation.

The following examples show how to add a dose object to a one-compartment PK model using `sbiodose` and set up the dose properties manually. Alternatively, you can use the built-in PK models with different dosing types. For details, see “Create Pharmacokinetic Models” on page 5-14.

Dosing Strategy	Example
Bolus	“Add a Series of Bolus Doses to a One-Compartment Model”
Infusion	“Add an Infusion Dose to a One-Compartment Model”
Zero-order	“Increase Drug Concentration in a One-Compartment Model via Zero-Order Dosing”
First-order	“Increase Drug Concentration in a One-Compartment Model via First-Order Dosing”

Create Dose Objects from Dosing Data

If you already have dosing data for one or more subjects or patients that you would like to use in your parameter estimation, first create a `groupedData` object from your data set. Use `createDoses` function to automatically generate an array of dose objects. You can then use the dose array during parameter estimation using `sbiofit` or `sbiofitmixed`. For a complete workflow, see “Modeling the Population Pharmacokinetics of Phenobarbital in Neonates” on page 4-153.

Creating Doses Graphically

You can interactively create and add doses using the **SimBiology Model Builder** app. For details, see “Add Doses” on page 1-26.

Parameterized and Adaptive Doses

You can specify some of the properties of `RepeatDose` and `ScheduleDose` objects by using model parameters. This parameterization of dose properties gives you more flexibility in modeling different dosing applications, such as scaling the dose amount by body weight.

`RepeatDose` properties that you can parameterize are: `Amount`, `Rate`, `Interval`, `StartTime`, `RepeatCount`, `LagParameterName`, and `DurationParameterName`. `ScheduleDose` properties that can be parameterized are `LagParameterName` and `DurationParameterName`. You can set these `RepeatDose` properties, except `LagParameterName` and `DurationParameterName`, to either a numeric value or the name of a model-scoped parameter (as a character vector or string).

You can make doses adaptive to events, such as increasing the dose amount when the drug concentration drops below some threshold. This adaptive feature of doses is useful for doses that are not instantaneous. Consider an IV infusion for a drug being added at a fixed rate over a fixed duration. If an event modifies a dose parameter while this dose is in progress, you have two options:

- Stop the ongoing dose if any relevant parameter values change by setting the `EventMode` property of the dose object to `'stop'`.
- Continue the ongoing dose to completion, and updated parameter values affect only subsequent doses by setting `EventMode` to `'continue'`.

For details, see the `EventMode` property. For illustrated examples, see “Scale Dose Amount by Body Weight” and “Change Dose Behavior In Response to Changes in Model Parameters”.

Units Validation on Parameterized Dose Properties

If you parameterize a dose property and enable dimensional analysis, the unit of the dose property (dose unit) is validated. The dose unit is valid either if it is empty or if it exactly matches the unit of the parameter. If the dose unit is invalid, SimBiology issues a warning and uses the unit of the parameter instead. To remove the warning, set the dose unit to empty (`' '`) or to the same unit as the parameter unit.

Simulation Solvers for Models Containing Doses

To simulate models containing doses, use a deterministic (ODE or SUNDIALS) solver. Stochastic solvers do not support doses. For details, see “Choosing a Simulation Solver” on page 4-7.

See Also

`sbiodose` | `adddose` | `ScheduleDose` object | `RepeatDose` object

More About

- “SimBiology Apps”

Simulate Biological Variability of the Yeast G Protein Cycle Using the Wild-Type and Mutant Strains

This example shows how to create and apply a variant to the G protein model of a wild-type strain. The variant represents a parameter value for the G protein model of a mutant strain. Thus, when you simulate the model without applying the variant, you see results for the wild type strain, and when you simulate the model with the variant, you see results for the mutant strain. This example uses the model described in Model of the Yeast Heterotrimeric G Protein Cycle on page B-14.

The value of the parameter k_{Gd} is 0.11 for the wild-type strain and 0.004 for the mutant strain. To represent the mutant strain, you will store an alternate value of 0.004 for the k_{Gd} parameter in a variant object, and apply this variant when simulating the model.

For information on variants, see “Variants in SimBiology Models” on page 2-29.

Load the `gprotein.sbproj` project, which includes the variable `m1`, a SimBiology model object.

```
sbioloadproject gprotein
```

You can create a variant of the original model by specifying a different parameter value for the k_{Gd} parameter of the model. First, add a variant to the `m1` model object.

```
v1 = addvariant(m1, 'mutant_strain');
```

Next, add a parameter k_{Gd} with a value of 0.004 to the variant object `v1`.

```
addcontent(v1, {'parameter', 'kGd', 'Value', 0.004});
```

Simulate the wild type model.

```
[t,x,names] = sbiosimulate(m1);
```

Simulate the mutant strain model by applying the variant.

```
[tV,xV,names] = sbiosimulate(m1,v1);
```

Plot and compare the simulated results.

```
subplot(1,2,1)
plot(t,x);
legend(names);
xlabel('Time');
ylabel('Amount');
title('Wild Type');
```

```
subplot(1,2,2)
plot(tV,xV);
legend(names);
xlabel('Time');
ylabel('Amount');
title('Mutant Strain');
```

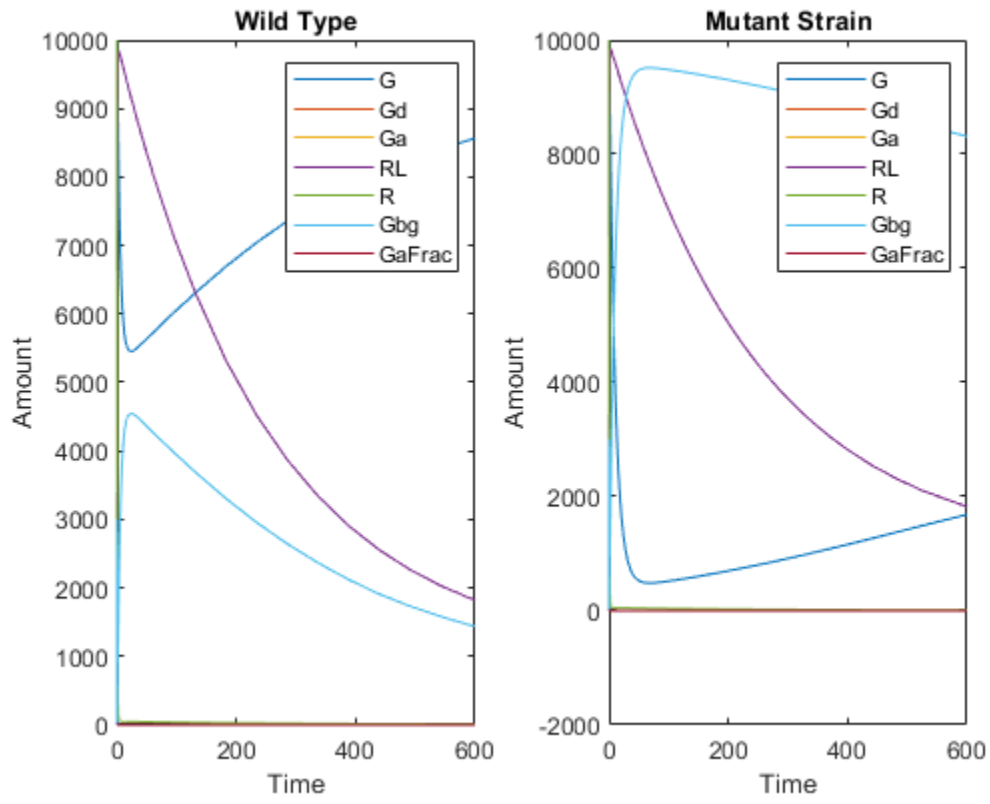

Create and Simulate a Model with a Custom Function

This example shows how to create a custom function and incorporate it in model simulation.

Overview

Prerequisites for the Example

This example assumes that you have a working knowledge of:

- MATLAB app
- Creating and saving MATLAB programs

About the Example Model

This example uses the model described in Model of the Yeast Heterotrimeric G Protein Cycle on page B-14.

This table shows the reactions used to model the G protein cycle and the corresponding rate parameters (rate constants) for each reaction. For reversible reactions, the forward rate parameter is listed first.

No.	Name	Reaction ¹	Rate Parameters
1	Receptor-ligand interaction	$L + R \rightleftharpoons RL$	k_{RL}, k_{RLm}
2	Heterotrimeric G protein formation	$Gd + Gbg \rightarrow G$	k_{G1}
3	G protein activation	$RL + G \rightarrow Ga + Gbg + RL$	k_{Ga}
4	Receptor synthesis and degradation	$R \rightleftharpoons \text{null}$	k_{Rdo}, k_{Rs}
5	Receptor-ligand degradation	$RL \rightarrow \text{null}$	k_{RD1}
6	G protein inactivation	$Ga \rightarrow Gd$	k_{Gd}

¹ Legend of species: L = ligand (alpha factor), R = alpha-factor receptor, Gd = inactive G-alpha-GDP, Gbg = free levels of G-beta:G-gamma complex, G = inactive Gbg:Gd complex, Ga = active G-alpha-GTP

Assumptions of the Example

This example assumes that:

- An inhibitor (Inhib species) slows the inactivation of the active G protein (reaction 6 above, $Ga \rightarrow Gd$).
- The variation in the amount of inhibitor (Inhib species) is defined in a custom function, `inhibvalex`.
- The inhibitor (Inhib species) affects the reaction by changing the amount of rate parameter k_{Gd} .

About the Example

This example shows how to create and call a custom function in a SimBiology expression. Specifically, it shows how to use a custom function in a rule expression.

About Using Custom Functions in SimBiology Expressions

You can use custom functions in:

- Reaction rate expressions (ReactionRate property)
- Rule expressions (Rule property)
- Event expressions (EventFcns property or Trigger property)

The requirements for using custom functions in SimBiology expressions are:

- Create a custom function. For more information, see `function`.
- Change the current folder to the folder containing your custom MATLAB file. Do this by using the `cd` command or by using the Current Folder field in the MATLAB desktop toolbar. Alternatively, add the folder containing your file to the search path. Do this by using the `addpath` command or see “Change Folders on Search Path”.
- Call the custom function in a SimBiology reaction, rule, or event expression.

Tip If your rule or reaction rate expression is not continuous and differentiable, see “Using Events to Address Discontinuities in Rule and Reaction Rate Expressions” on page 2-28 before simulating your model.

Create a Custom Function

The following procedure creates a custom function, `inhibvalex`, which lets you specify how the inhibitor amount changes over time. The inputs are time, the initial amount of inhibitor, and a parameter that governs the amount of inhibitor. The output of the function is the amount of inhibitor.

In the MATLAB desktop, select **File > New > Script**, to open the MATLAB Editor.

Copy and paste the following function declaration:

```
% inhibvalex.m
function Cp = inhibvalex(t, Cpo, kel)

% This function takes the input arguments t, Cpo, and kel
% and returns the value of the inhibitor Cp.
% You can later specify the input arguments in a
% SimBiology rule expression.
% For example in the rule expression, specify:
% t as time (a keyword recognized as simulation time),
% Cpo as a parameter that represents the initial amount of inhibitor,
% and kel as a parameter that governs the amount of inhibitor.

if t < 400
    Cp = Cpo*exp(-kel*(t));
else
    Cp = Cpo*exp(-kel*(t-400));
end
```

Save the file (name the file `inhibvalex.m`) in a directory that is on the MATLAB search path, or to a directory that you can access.

If the location of the file is not on the MATLAB search path, change the working directory to the file location.

Load the Example Model

Load the `gprotein` example project, which includes the variable `m1`, a model object:

```
sbioloadproject gprotein
```

The `m1` model object appears in the MATLAB Workspace.

Add the Custom Function to the Example Model

The following procedure creates a rule expression that calls the custom function, `inhibvalex`, and specifies the three input values to this function.

Add a repeated assignment rule to the model that specifies the three input values to the custom function, `inhibvalex`:

```
rule1 = addrule(m1, 'Inhib = inhibvalex(time, Cpo, Kel)',...
                'repeatedAssignment');
```

The `time` input is a SimBiology keyword recognized as simulation time

Create the two parameters used by the `rule1` rule and assign values to them:

```
p1 = addparameter(m1, 'Cpo', 250);
p2 = addparameter(m1, 'Kel', 0.01);
```

Create the species used by the `rule1` rule:

```
s1 = addspecies(m1.Compartments, 'Inhib');
```

Define a Rule to Change Parameter Value

The value of rate parameter `kGd` is affected by the amount of inhibitor present in the system. Add a rule to the model to describe this action, but first change the `ConstantValue` property of the parameter `kGd` so that it can be varied by a rule.

Change the `ConstantValue` property of the `kGd` parameter to `false`.

```
p3 = sbioselect(m1, 'Type', 'parameter', 'Name', 'kGd');
p3.ConstantValue = false;
```

Add a repeated assignment rule to the model to define how the `kGd` parameter is affected by the `Inhib` species.

```
rule2 = addrule(m1, 'kGd = 1/Inhib', 'repeatedAssignment');
```

Add an Event to Reset the Solver at a Discontinuity and Simulate the Model

The custom function, `inhibvalex`, introduces a discontinuity in the model when `time = 400`. To ensure accurate simulation results, add an event to the model to reset the solver at the time of the

discontinuity. Set the event to trigger at the time of the discontinuity (time = 400). The event does not need to modify the model, so create an event function that multiplies a species value by 1.

```
addevent(m1, 'time>=400', 'G=1*G');
```

Configure the simulation settings (`configset` object) for the `m1` model object to log all states during the simulation.

```
cs = getconfigset(m1);
cs.RuntimeOptions.StatesToLog = 'all';
```

Simulate the model.

```
simDataObj = sbiosimulate(m1);
```

Plot the results.

```
sbioplot(simDataObj);
```

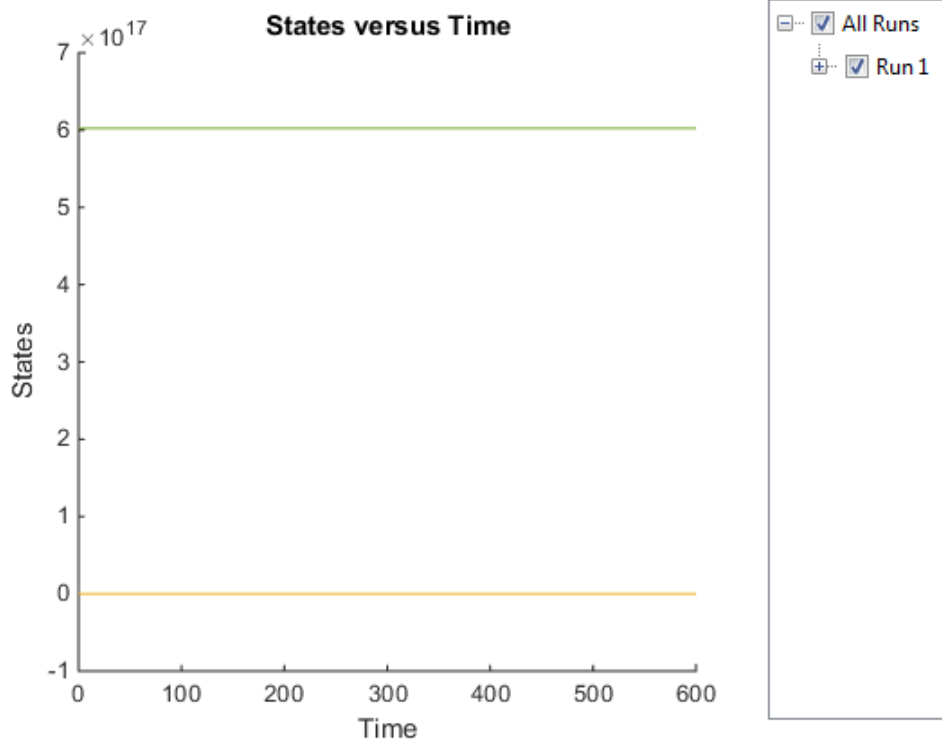

The plot does not show the species of interest due to the wide range in species amounts/concentrations.

Plot only the species of interest. Ga.

```
GaSimDataObj = selectbyname(simDataObj, 'Ga');
sbioplot(GaSimDataObj);
```

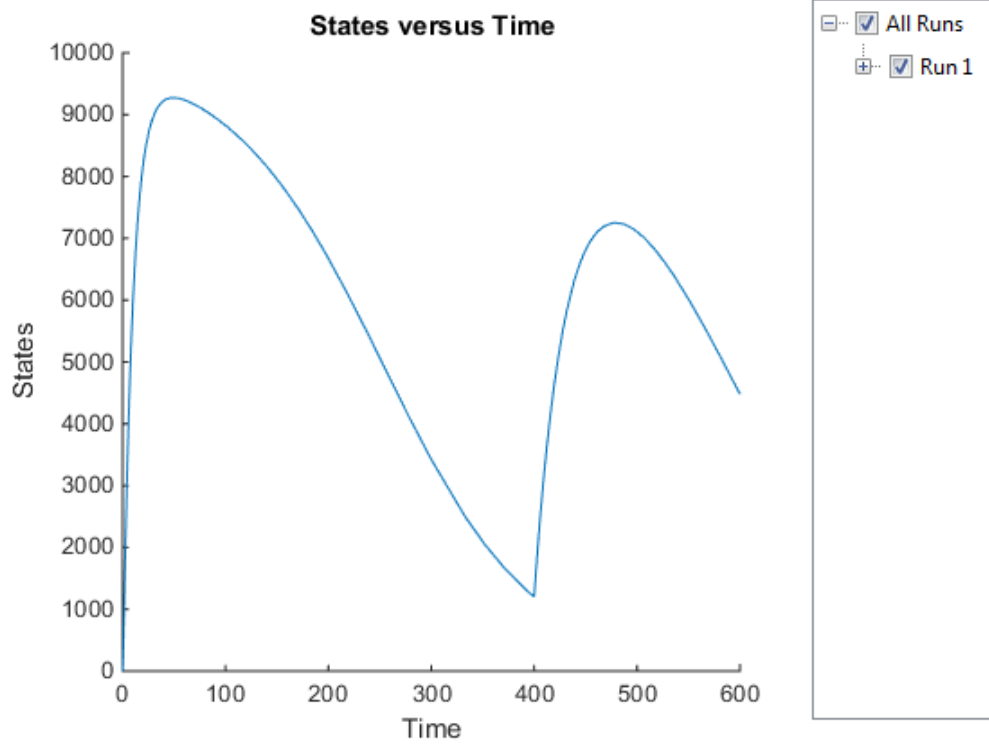

Notice the change in the profile of species Ga at time = 400 seconds (simulation time). This is the time when the inhibitor amount is changed to reflect the re-addition of inhibitor to the model.

Plot only the inhibitor (Inhib species).

```
InhibSimDataObj = selectbyname(simDataObj, 'Inhib');  
sbioplot(InhibSimDataObj)
```

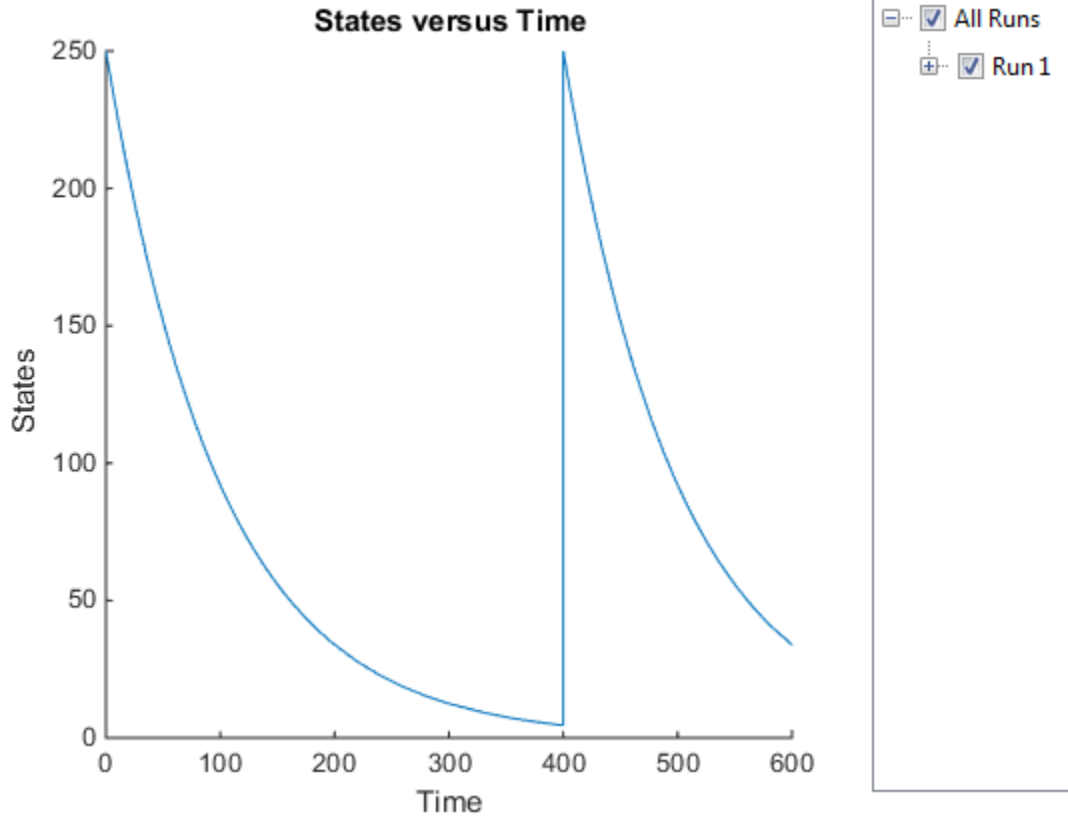

See Also

`function` | `cd` | `addpath`

More About

- “Construct a Simple Model”
- “Change Folders on Search Path”

Component Usage

SimBiology lets you find species, parameters, and compartments that are not used in a model. You can also query how a particular quantity is used by other expressions such as a parameter being used as a reaction rate constant or species being used in an event.

From the command line, use the `findUnusedComponents` function to look for unused model components and the `findUsages` function to see how a component is used in expressions. If you are using the SimBiology Model Builder app, in the **Browser** pane, expand **Model Assessment Tools**. Then click **Unused** to see a list of unused quantities. To look for usages of a quantity, click the quantity block in the diagram or in the browser table. Then in the **Property Editor** pane, look at the **Usages** section.

Species Usage

A species is used when it is referenced in any of the following properties of other components:

- The `Reaction` or `ReactionRate` property of a `Reaction` object,
- The `ParameterVariableNames` or `SpeciesVariableNames` property of a `KineticLaw` object,
- The `Rule` property of a `Rule` object,
- The `Trigger` or `EventFcns` property of an `Event` object,
- The `Expression` property of an observable object, and
- The `TargetName` property of a `ScheduleDose` object or `RepeatDose` object.

Use the object method `findUsages` to find out how a species is used.

Parameter Usage

A parameter is used when it is referenced in any of the following properties of other components:

- The `ReactionRate` property of a `Reaction` object,
- The `ParameterVariableNames` property of a `KineticLaw` object,
- The `Rule` property of a `Rule` object,
- The `Trigger` or `EventFcns` property of an `Event` object,
- The `Expression` property of an observable object,
- The `Content` property of a `Variant` object, and
- The `DurationParameterName` or `LagParameterName` property of a `ScheduleDose` object or `RepeatDose` object.
- The `Amount`, `Rate`, `Interval`, `StartTime`, or `RepeatCount` property of a `RepeatDose` object.

Use the object method `findUsages` to find out how a parameter is used.

Compartment Usage

A compartment is used when it is referenced in any of the following properties of other components:

- The `Parent` property of a `Species` object,

- The `Owner` property of a `Compartment` object,
- The `ReactionRate` property of a `Reaction` object,
- The `ParameterVariableNames` property of a `KineticLaw` object,
- The `Rule` property of a `Rule` object,
- The `Trigger` or `EventFcns` property of an `Event` object,
- The `Expression` property of an observable object, and
- The `Content` property of a `Variant` object.

Use the object method `findUsages` to find out how a compartment is used.

Observable Usage

An observable object is used when it is referenced in the `Expression` property of another observable.

Use the object method `findUsages` to find out how an observable object is used.

Unit and UnitPrefix Usage

A unit or unit prefix is used when it is referenced in any of the following properties of other components:

- The `Composition` property of all units in the `BuiltInLibrary` and `UserDefinedLibrary`,
- The `Units` property of a species, compartment, parameter, or observable object in the specified models,
- The `TimeUnits` property of all specified doses,
- The `AmountUnits` property of all specified doses, and
- The `RateUnits` property of all specified doses.

Use the object method `findUsages` to find out how a `Unit` or `UnitPrefix` object is used.

Abstract Kinetic Law Usage

An abstract kinetic law object `aklObj` can only be used by a `Reaction` object `robj`. It is used when:

- The `KineticLaw` property of the reaction object is not empty, *and*
- `robj.KineticLaw.KineticLawName` matches the name of the abstract kinetic law `aklObj.Name`.

Use the object method `findUsages` to find out how an `AbstractKineticLaw` object is used.

See Also

`findUnusedComponents`

More About

- “What is a SimBiology Model?” on page 2-2

- “SimBiology Apps”
- “Evaluation of Model Component Names in Expressions” on page 2-44

Evaluation of Model Component Names in Expressions

SimBiology model components on page 2-2 include quantities and expressions. You can refer to model quantities (compartments, species, and parameters) and observables by their names in an expression, such as a reaction or an assignment equation. Follow these guidelines when you name model components or referencing their names in expressions. When evaluating a name that matches different quantities, SimBiology resolves it by following precedence rules.

Guidelines for Naming Model Components

- Model, parameter, and observable names cannot contain brackets [] and cannot be empty, the word `time`, or all whitespace.
- Compartment, species, and observable names cannot contain the characters `->`, `<->`, `[` or `]` and cannot be empty, the word `null`, or the word `time`. However, a name can contain the words `null` and `time` within the name, such as `nullDrug`.
- Reaction, event, and rule names cannot contain brackets [] and cannot be the word `time`.
- You cannot set a reaction name to an empty character vector (`' '`) or empty string (`''`).

Note SimBiology removes any leading or trailing whitespaces from model component names.

Guidelines for Referencing Names in Expressions

- If the quantity name is not a valid MATLAB variable name, you must enclose the name in brackets when referring to it in an expression. For example, if the name of a species is *DNA polymerase+*, write `[DNA polymerase+]`.
- If you have multiple species with the same name in different compartments, you must qualify the name by referring to the name of the compartment that contains the species. For example, the qualified name *nucleus*. `[DNA polymerase+]` refers to the *DNA polymerase+* species that resides in the *nucleus* compartment.

Precedence Rules for Evaluating Quantity Names

If a name referenced in an expression matches multiple quantities or `observable` objects, SimBiology evaluates the expression using precedence rules. The rules depend on whether the name is referenced in a reaction or other expressions that are not reactions.

For Reactions

When a reaction refers to a name that matches different quantities, SimBiology evaluates the name as the first quantity with a matching name in this order: species, parameter scoped to the reaction, compartment, or parameter scoped to the model.

For Other Expressions

There are different types of expressions that are not reactions, namely rules, events, and observables. Rules include initial and repeated assignment equations, algebraic equations, and differential rate equations. An event contains expressions that represent an event trigger and one or more event functions to model discrete transitions in the values of quantities or expressions in the model. An `observable` object is a mathematical expression that lets you perform post-simulation calculations.

When a nonreaction expression refers to a name that matches different quantities, SimBiology evaluates the name as the first quantity with a matching name in this order: species, compartment, or parameter scoped to the model. An active observable expression can reference another active observable object by its name as long as there are no circular dependencies (or algebraic loops).

See Also

Name

More About

- “What is a SimBiology Model?” on page 2-2
- “Definitions and Evaluations of Reactions in SimBiology Models” on page 2-8
- “Definitions and Evaluations of Rules in SimBiology Models” on page 2-13
- “Events in SimBiology Models” on page 2-22
- “Component Usage” on page 2-41

SimBiology Model Matching Policy

To report the differences on page 2-48 between the source and target models, SimBiology first decides which components of the models match one another. The matching process includes the following criteria:

- Criterion 1 - Two components are considered the *same* if both are derived from one single model. For instance, duplicated models in the app, or the same models saved to and loaded from different versions of SBPROJ files, are derived from one single model.
- Criterion 2 - Two components are considered *equivalent* if criterion 1 is not applicable to these components but they can be uniquely matched by one of the corresponding properties, such as `Name`, `Reaction`, `Rule`, and so on.

The following sections describe how SimBiology matches different types of model components.

Model Quantities

Model quantities include species, compartments, and parameters. SimBiology first matches them using criterion 1. Then, it matches all the remaining quantities using criterion 2. That is, components of the same type that have not yet been matched are compared by the `Name` property. However, parameters are matched only if they are scoped to matching reactions or if one of the parameters is model-scoped.

Model Expressions

Expression-based components are reactions, rules, events, and observables.

SimBiology matches these components using criterion 1 first. Then it matches all the remaining expression-based components using criterion 2. That is, components of the same type that have not yet been matched are compared by the `Name` property and one of the following properties for reactions, rules, and events:

- `Reaction` property for reactions
- `Rule` property for rules
- `Trigger` property for events

SimBiology accounts for the changes in these properties (the expression strings) that are caused by the dependent changes. The dependent changes are the side effects of changing the `Name`, `Parent`, or `Owner` properties of a quantity component. When these properties change, they trigger changes in other components referencing the quantity. For instance, the `Reaction` property of a reaction `C1.S1 -> C1.S2` changes to `C1.S3 -> C1.S2` when you rename the species `S1` residing in a compartment `C1` to `S3`. Such changes are not included in the comparison results of `sbiodiff`. If you are using the Comparison tool on page 2-48, such changes are automatically hidden.

For kinetic law objects, they match if their parent reactions match.

Doses and Variants

Variants and doses are matched using criterion 1 first. Then the remaining doses and variants are matched using criterion 2. That is, components of the same type that have not yet been matched are compared by the `Name` property.

Note that for doses, the subtype (`RepeatDose` or `ScheduleDose`) must match also.

Variants can contain multiple rows in their corresponding `Content` property. Each row of the `Content` cell array includes values for the component type, component name, property name, and property value. When comparing variants with such content, SimBiology matches the property names of the rows and reports the last occurrence if there are duplicate rows with the same component type and component name.

Determine Differences in Component Properties

After model components are matched, SimBiology next determines if the property values of matching components are different. All properties (except the `UserData` property) of each model component are included in the comparison results.

If either model has a diagram, SimBiology also reports any graphical differences between the diagrams. Specifically, it includes the following properties of graphical blocks of the corresponding model components and graphical lines.

- Graphical block properties: `Position`, `Visible`, `Pin`, `Shape`, `Rotate`, `FontName`, `FontSize`, `FontWeight`, `TextLocation`, `FaceColor`, `EdgeColor`, and `TextColor`.
- Graphical line properties: `Color` and `Width`.

Each of these graphical block properties is reported as a property of the corresponding model component in the comparison results. Similarly, if species blocks have any clones, the clones are also matched and reported as properties of the parent block.

See Also

`sbiodiff` | `SimBiology.DiffResults`

Related Examples

- “Compare SimBiology Models” on page 2-48
- “What is a SimBiology Model?” on page 2-2

Compare SimBiology Models

You can compare two SimBiology models and generate a list of differences between them. If the models contain diagram (graphical) information, the comparison results also include differences for the model diagrams. For details on how SimBiology compares and matches model components, see “SimBiology Model Matching Policy” on page 2-46.

Compare Models Programmatically

Use `sbiodiff` at the command line. It returns a `SimBiology.DiffResults` object that contains the comparison results.

Compare Models Graphically

To view the comparison results graphically in the Comparison tool, do one of the following:

- At the command line, call `visdiff(diffResults)`, where `diffResults` is the `SimBiology.DiffResults` object returned by `sbiodiff`.
- At the command line, call `visdiff` with two SBPROJ files as inputs.
- On the **Home** tab of the MATLAB desktop, click **Compare** and select two SBPROJ files.
- Select two SBPROJ files in the **Current Folder** panel of the MATLAB desktop. Right-click and select **Compare Selected Files/Folders**.

The next figure shows an example of the Comparison tool comparing two models side by side. It uses different colors to indicate the insertion, deletion, and modification of model components. The tool lists the components in the order that they appear in the corresponding model.

COMPARISON

Previous Next Filter

NAVIGATE FILTER

Source: SGLT2_insulin_glucose_model Target: SGLT2_insulin_glucose_model

SGLT2_insulin_glucose_model Whole_Body

- Stomach_Glucose_Solid
- Stomach_Glucose_Tritur
- Stomach_Glucose
- Gut_Glucose
- Plasma_Glucose
- Tissue_Glucose
- Insulin_Delay_2
- Insulin_Delay_1
- Plasma_Insulin_Conc
- Interstitial_Insulin
- Plasma_Insulin
- Liver_Insulin
- Portal_Insulin
- GI_SGLT2_Inhib
- Plasma_SGLT2_Inhib
- Urinary_Glucose_Excr_AUC
- timeEveningMeal
- timeLunch
- [Stomach Glucose After Dosing]
- gastric_emptying_a
- gastric_emptying_c

SGLT2_insulin_glucose_model Whole_Body

- Meal
- Stomach_Glucose_Solid
- Stomach_Glucose_Tritur
- Stomach_Glucose
- Gut_Glucose
- Plasma_Glucose
- Plasma_Glucose_Conc
- Tissue_Glucose
- GI_SGLT2_Inhib
- Plasma_SGLT2_Inhib
- Insulin_Delay_2
- Insulin_Delay_1
- Plasma_Insulin_Conc
- Interstitial_Insulin
- Plasma_Insulin
- Liver_Insulin
- Portal_Insulin
- Urinary_Glucose_Excr_AUC_24hr
- timeEveningMeal
- timeLunch
- [Stomach Glucose After Dosing]
- gastric_emptying_a
- gastric_emptying_c

Component property	Value	Component property	Value
Value	0.000000	Value	0.100000
Notes		Notes	amount of hypothetical SGLT2 inhibitor in ...
Graphical property	Value	Graphical property	Value
FontSize	14.000	FontSize	12.000
FontWeight	plain	FontWeight	bold
TextLocation	bottom	TextLocation	center
FaceColor	[0.831 0.855 0.925]	FaceColor	[0.929 0.698 0.125]
EdgeColor	[0.600 0.655 0.820]	EdgeColor	[0.502 0.502 0.502]

Insertion Deletion Modification

The **Previous** and **Next** buttons in the toolbar let you step through each difference. Use the **Filter** menu to customize the comparison results. The middle section of the app contains the tree of the matched model components. The bottom section shows the property values of the model components selected in the middle section.

By default, the tool hides the unchanged properties, dependent changes, and unchanged components. The **Filter** menu gives additional criteria to fine-tune the results. For example, you can hide the quantity-based components (compartment, species, and parameters), the expression-based components (reactions, rules, events, and observables), and graphical changes.

Note The dependent changes are the side effects of changing the Name, Parent, or Owner properties of a quantity component. When these properties change, they trigger changes in other components referencing the quantity component. For instance, the Reaction property of a reaction C1.S1 -> C1.S2 changes to C1.S3 -> C1.S2 when you rename the species S1 residing in a compartment C1 to S3. The app hides such dependent changes by default.

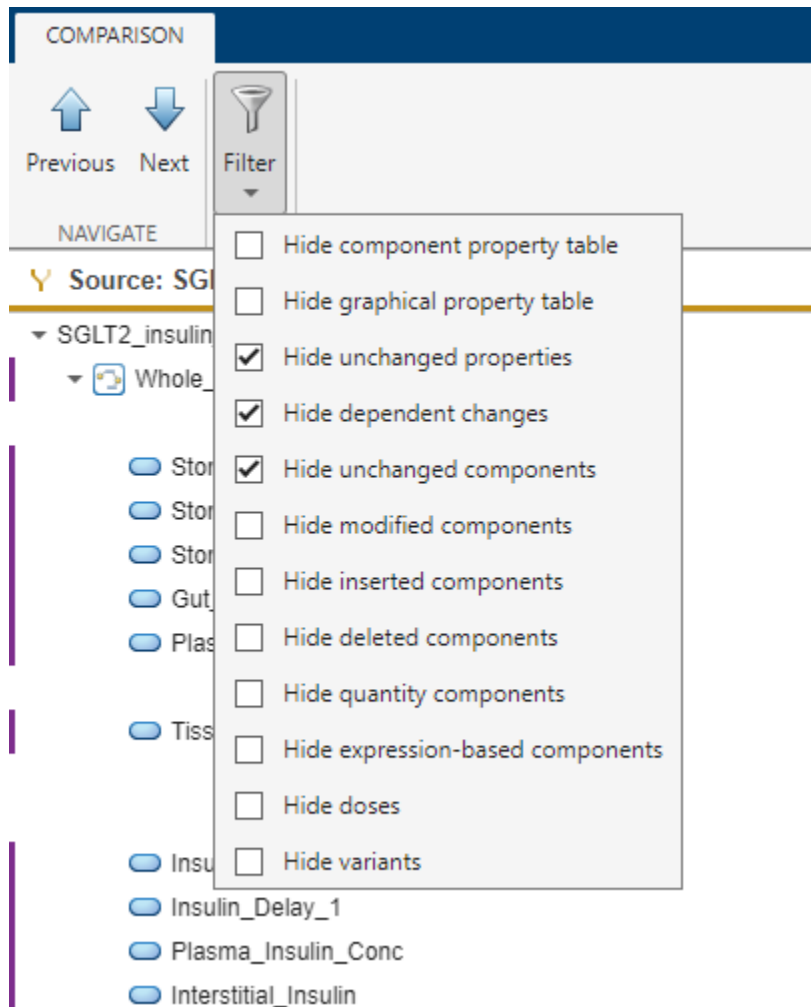

Git Integration

You can compare different versions of SBPROJ files that you have in a Git repository from within MATLAB as shown next. For details on setting up a Git repository, see "Use Git in MATLAB".

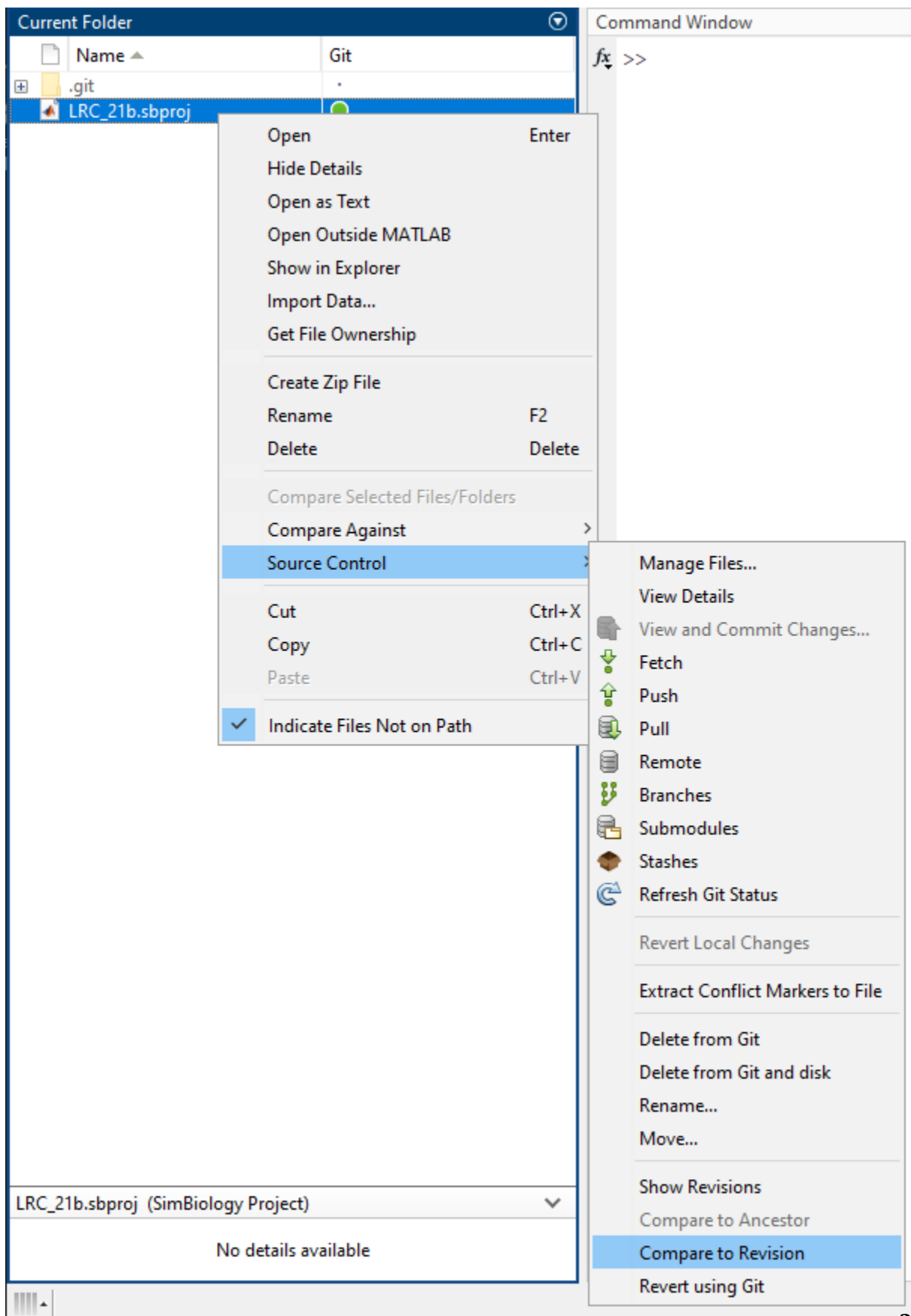

See Also

sbiodiff | SimBiology.DiffResults

Related Examples

- “SimBiology Model Matching Policy” on page 2-46

Structural Analysis

- “Model Verification” on page 3-2
- “Conserved Moiety Determination” on page 3-4
- “Determining Conserved Moieties” on page 3-6
- “Determining the Adjacency Matrix for a Model” on page 3-9
- “Determining the Stoichiometry Matrix for a Model” on page 3-11
- “Selecting Absolute Tolerance and Relative Tolerance for Simulation” on page 3-13
- “Troubleshooting Simulation Problems” on page 3-15
- “Simulate Model of Glucose-Insulin Response with Different Initial Conditions” on page 3-18
- “Combine Simulation Scenarios in SimBiology” on page 3-23

Model Verification

In this section...
“What is Model Verification?” on page 3-2
“When to Verify a Model” on page 3-2
“Verifying That a Model Has No Warnings or Errors” on page 3-2
“Model Verification Example” on page 3-3
“View Model Equations” on page 3-3

What is Model Verification?

SimBiology has functionality that helps you find and fix warnings that you might need to be aware of, and errors that would prevent you from simulating and analyzing your model.

Model verification checks many aspects of the model including:

- Model structure
- Validity of mathematical expressions
- Dimensional analysis
- Unit conversion issues

When to Verify a Model

You can check your model for warnings and errors at any time when constructing or working with your model. For example:

- Verify your model during construction to ensure that the model is complete.
- Verify the model after changing simulation settings, dimensional analysis settings, or unit conversion settings.

Analyses such as simulation, scanning, and parameter fitting automatically verify a model.

Tip Repeatedly running a task using a different variant or setting a different value for the `InitialAmount` property of a species, the `Capacity` property of a compartment, or the `Value` property of a parameter, generates warnings only the first time you simulate a model. Use the verification functionality described in this section to display warnings again.

Verifying That a Model Has No Warnings or Errors

Use the `verify` method to see a list of warnings and errors in your model.

Use the `sbiolastwarning` and `sbiolasterror` functions to return the last warning and last error encountered during verification.

Model Verification Example

- 1 Create a model with a reaction that references K1, an undefined parameter:

```
% Create a model named example
model = sbiomodel('example');
% Add a compartment named cell to model
compartment = addcompartment(model, 'cell');
% Add two species, A and B, to the cell compartment
species_1 = addspecies(compartment, 'A');
species_2 = addspecies(compartment, 'B');
% Add the reaction A -> B to the model
reaction = addreaction(model, 'A -> B', 'ReactionRate', 'K1');
```

- 2 Verify the model to check for warnings and errors:

```
verify(model)

??? -> Error reported from Expression Validation:
The name 'K1' in reaction 'A -> B' does not refer to any in-scope species,
parameters, or compartments.
```

- 3 Address the error by defining the parameter K1:

```
% Add a parameter, K1, to the model with a value of 3
parameter = addparameter(model, 'K1', 3);
```

- 4 Verify the model again:

```
verify(model)
```

View Model Equations

As you verify the model, you can view the underlying system of equations of the model. Viewing model equations is useful for:

- Publishing purposes
- Model debugging

For details, see `getequations` or “Show Model Equations and Initial Conditions” on page 1-31.

Conserved Moiety Determination

In this section...

“Introduction to Moiety Conservation” on page 3-4

“Algorithms for Conserved Cycle Calculations” on page 3-4

“More About” on page 3-5

Introduction to Moiety Conservation

Conserved moieties represent quantities that are conserved in a system, regardless of the individual reaction rates.

Consider this simple network:

```
reaction 1: A -> B
reaction 2: B -> C
reaction 3: C -> A
```

Regardless of the rates of reactions 1, 2, and 3, the quantity $A + B + C$ is conserved throughout the dynamic evolution of the system. This conservation is termed structural because it depends only on the structure of the network, rather than on details such as the kinetics of the reactions involved. In the context of systems biology, such a conserved quantity is sometimes referred to as a conserved moiety. A typical, real-world example of a conserved moiety is adenine in its various forms ATP, ADP, AMP, etc. Finding and analyzing conserved moieties can yield insights into the structure and function of a biological network. In addition, for the quantitative modeler, conserved moieties represent dependencies that can be removed to reduce a system’s dimensionality, or number of dynamic variables. In the previous simple network, in principle, it is only necessary to calculate the time courses for A and B. After this is done, C is fixed by the conservation relation.

Algorithms for Conserved Cycle Calculations

The `sbioconsmoiety` function analyzes conservation relationships in a model by calculating a complete set of linear conservation relations for the species in the model object.

`sbioconsmoiety` lets you specify one of three algorithms based on the nature of the model and the required results:

- `'qr'` — `sbioconsmoiety` uses an algorithm based on QR factorization. From a numerical standpoint, this is the most efficient and reliable approach.
- `'rreduce'` — `sbioconsmoiety` uses an algorithm based on row reduction, which yields better numbers for smaller models. This is the default.
- `'semipos'` — `sbioconsmoiety` returns conservation relations in which all the coefficients are greater than or equal to zero, permitting a more transparent interpretation in terms of physical quantities.

For larger models, the QR-based method is recommended. For smaller models, row reduction or the semipositive algorithm may be preferable. For row reduction and QR factorization, the number of conservation relations returned equals the row rank degeneracy of the model object's stoichiometry matrix. The semipositive algorithm can return a different number of relations. Mathematically speaking, this algorithm returns a generating set of vectors for the space of semipositive conservation relations.

In some situations, you may be interested in the dimensional reduction of your model via conservation relations. Recall the simple model, presented in “Introduction to Moiety Conservation” on page 3-4, that contained the conserved cycle $A + B + C$. Given A and B, C is determined by the conservation relation; the system can be thought of as having only two dynamic variables rather than three. The 'link' algorithm specification caters to this situation. In this case, `sbioconsmoiety` partitions the species in the model into independent and dependent sets and calculates the dependence of the dependent species on the independent species.

Consider a general system with an n -by- m stoichiometry matrix N of rank k , and suppose that the rows of N are permuted (which is equivalent to permuting the species ordering) so that the first k rows are linearly independent. The last $n - k$ rows are then necessarily dependent on the first k rows.

The matrix N can be split into the following independent and dependent parts,

$$N = \begin{pmatrix} N_R \\ N_D \end{pmatrix}$$

where R in the independent submatrix N_R denotes 'reduced'; the $(n - k)$ -by- k link matrix $L\theta$ is defined so that $N_D = L\theta * N_R$. In other words, the link matrix gives the dependent rows N_D of the stoichiometry matrix, in terms of the independent rows N_R . Because each row in the stoichiometry matrix corresponds to a species in the model, each row of the link matrix encodes how one dependent species is determined by the k independent species.

More About

For examples of determining conserved moieties, see:

- “Determining Conserved Moieties” on page 3-6
- “Finding Conserved Quantities in a Pathway Model” on page 4-145

Determining Conserved Moieties

- 1 Load the Goldbeter Mitotic Oscillator project, which includes the variable `m1`, a model object:

```
sbioloadproject Goldbeter_Mitotic_Oscillator_with_reactions
```

The `m1` model object appears in the MATLAB Workspace.

- 2 Display the species information:

```
m1.Compartments.Species
```

```
SimBiology Species Array
```

Index:	Compartment:	Name:	InitialAmount:	InitialAmountUnits:
1	unnamed	C	0.01	
2	unnamed	M	0.01	
3	unnamed	Mplus	0.99	
4	unnamed	Mt	1	
5	unnamed	X	0.01	
6	unnamed	Xplus	0.99	
7	unnamed	Xt	1	
8	unnamed	V1	0	
9	unnamed	V3	0	
10	unnamed	AA	0	

- 3 Display the reaction information:

```
m1.Reactions
```

```
SimBiology Reaction Array
```

Index:	Reaction:
1	AA -> C
2	C -> AA
3	C + X -> AA + X
4	Mplus + C -> M + C
5	M -> Mplus
6	Xplus + M -> X + M
7	X -> Xplus

- 4 Use the simplest form of the `sbioconsmoiety` function and display the results. The default call to `sbioconsmoiety`, in which no algorithm is specified, uses an algorithm based on row reduction.

```
[g sp] = sbioconsmoiety(m1)
```

```
g =
```

0	1	1	0	0	0
0	0	0	1	1	0
0	0	0	0	0	1

```
sp =
```

```
'C'  
'M'  
'Mplus'  
'X'
```

```
'Xplus'
'AA'
```

The columns in `g` are labeled by the species `sp`. Thus the first row describes the conserved relationship, $M + Mplus$. Notice that the third row indicates that the species `AA` is conserved, which is because `AA` is constant (`ConstantAmount = 1`).

- 5** Call `sbioconsmoiety` again, this time specifying the semipositive algorithm to explore conservation relations in the model. Also specify to return the conserved moieties in a cell array of character vectors, instead of a matrix.

```
cons_rel = sbioconsmoiety(m1, 'semipos', 'p')
```

```
cons_rel =
```

```
'AA'
'X + Xplus'
'M + Mplus'
```

- 6** Use the `'link'` option to study the dependent and independent species.

```
[SI,SD,L0,NR,ND] = sbioconsmoiety(m1, 'link');
```

- 7** Show the list of independent species:

```
SI
```

```
SI =
```

```
'C'
'M'
'X'
```

- 8** Show the list of dependent species:

```
SD
```

```
SD =
```

```
'Mplus'
'Xplus'
'AA'
```

- 9** Show the link matrix relating `SD` and `SI` by converting the `L0` output from a sparse matrix to a full matrix:

```
L0_full = full(L0)
```

```
L0_full =
```

```
  0  -1.0000  0
  0   0  -1.0000
  0   0   0
```

- 10** Show the independent stoichiometry matrix, N_r by converting the `NR` output from a sparse matrix to a full matrix:

```
NR_full = full(NR)
```

```
NR_full =
```

```
  1  -1  -1  0  0  0  0
```

0	0	0	1	-1	0	0
0	0	0	0	0	1	-1

- 11** Show the dependent stoichiometry matrix, N_D by converting the ND output from a sparse matrix to a full matrix:

```
ND_full = full(ND)
```

```
ND_full =
```

0	0	0	-1	1	0	0
0	0	0	0	0	-1	1
0	0	0	0	0	0	0

Determining the Adjacency Matrix for a Model

In this section...

“What Is an Adjacency Matrix?” on page 3-9

“Retrieving an Adjacency Matrix for a Model” on page 3-9

What Is an Adjacency Matrix?

An adjacency matrix is a square matrix that provides information on reactants and products of reactions in a model. It lets you easily determine:

- The reactants and products in a specific reaction in a model
- The reactions that a specific species is part of, and whether the species is a reactant or product in that reaction

An adjacency matrix is an N -by- N matrix, where N equals the total number of species and reactions in a model. Each row corresponds to a species or reaction, and each column corresponds to a species or reaction.

The matrix indicates which species and reactions are involved as reactants and products:

- Reactants are represented in the matrix with a 1 at the appropriate location (row of species, column of reaction). Reactants appear above the diagonal.
- Products are represented in the matrix with a 1 at the appropriate location (row of reaction, column of species). Products appear below the diagonal.
- All other locations in the matrix contain a 0.

For example, if a `model` object contains one reaction equal to $A + B \rightarrow C$ and the `Name` property of the reaction is `R1`, the adjacency matrix is:

	A	B	C	R1
A	0	0	0	1
B	0	0	0	1
C	0	0	0	0
R1	0	0	1	0

Retrieving an Adjacency Matrix for a Model

Retrieve an adjacency matrix for a model by passing the `model` object as an input argument to the `getadjacencymatrix` method.

- 1 Read in `m1`, a model object, using `sbmlimport`:

```
m1 = sbmlimport('lotka.xml');
```

- 2 Get the adjacency matrix for `m1`:

```
[M, Headings] = getadjacencymatrix(m1)
```

```
M =
```

```
(5,1)      1
(5,2)      1
```

```
(6,3)      1
(7,4)      1
(1,5)      1
(2,5)      1
(2,6)      1
(3,6)      1
(3,7)      1
```

Headings =

```
'x'
'y1'
'y2'
'z'
'Reaction1'
'Reaction2'
'Reaction3'
```

- 3** Convert the adjacency matrix from a sparse matrix to a full matrix to more easily see the relationships between species and reactions:

```
M_full = full(M)
```

```
M_full =
```

```
  0  0  0  0  1  0  0
  0  0  0  0  1  1  0
  0  0  0  0  0  1  1
  0  0  0  0  0  0  0
  1  1  0  0  0  0  0
  0  0  1  0  0  0  0
  0  0  0  1  0  0  0
```

See Also

getadjacencymatrix

More About

- “Determining the Stoichiometry Matrix for a Model” on page 3-11

Determining the Stoichiometry Matrix for a Model

In this section...

“What Is a Stoichiometry Matrix?” on page 3-11

“Retrieving a Stoichiometry Matrix for a Model” on page 3-11

What Is a Stoichiometry Matrix?

A stoichiometry matrix provides stoichiometric information about reactants and products in model reactions. It lets you easily determine:

- The reactants and products in a specific reaction in a model, including the stoichiometric value of the reactants and products
- The reactions that a specific species is part of, and whether the species is a reactant or product in that reaction

A stoichiometry matrix is an M -by- R matrix, where M equals the total number of species in a model, and R equals the total number of reactions in a model. Each row corresponds to a species, and each column corresponds to a reaction.

The matrix indicates which species and reactions are involved as reactants and products:

- Reactants are represented in the matrix with their stoichiometric value at the appropriate location (row of species, column of reaction). Reactants appear as negative values.
- Products are represented in the matrix with their stoichiometric value at the appropriate location (row of species, column of reaction). Products appear as positive values.
- All other locations in the matrix contain a 0.

For example, consider a `model` object containing two reactions. One reaction (named R1) is equal to $2 A + B \rightarrow 3 C$, and the other reaction (named R2) is equal to $B + 3 D \rightarrow 4 A$. The stoichiometry matrix is:

	R1	R2
A	-2	4
B	-1	-1
C	3	0
D	0	-3

Retrieving a Stoichiometry Matrix for a Model

Retrieve a stoichiometry matrix for a model by passing the `model` object as an input argument to the `getstoichmatrix` method.

- 1 Read in `m1`, a model object, using `sbmlimport`:

```
m1 = sbmlimport('lotka.xml');
```

- 2 Get the stoichiometry matrix for `m1`:

```
[M,objSpecies,objReactions] = getstoichmatrix(m1)
```

```
M =
```

```
(2,1)    1
(2,2)   -1
(3,2)    1
(3,3)   -1
(4,3)    1
```

```
objSpecies =
```

```
'x'
'y1'
'y2'
'z'
```

```
objReactions =
```

```
'Reaction1'
'Reaction2'
'Reaction3'
```

- 3** Convert the stoichiometry matrix from a sparse matrix to a full matrix to more easily see the relationships between species and reactions:

```
M_full = full(M)
```

```
M_full =
```

```
  0    0    0
  1   -1    0
  0    1   -1
  0    0    1
```

See Also

getstoichmatrix

More About

- “Determining the Adjacency Matrix for a Model” on page 3-9

Selecting Absolute Tolerance and Relative Tolerance for Simulation

In this section...

“Algorithm” on page 3-13

“Absolute Tolerance Scaling” on page 3-13

SimBiology uses `AbsoluteTolerance` and `RelativeTolerance` to control the accuracy of integration during simulation. Specifically, `AbsoluteTolerance` is used to control the largest allowable absolute error at any step during simulation. It controls the error when a solution is small. Intuitively, when the solution approaches 0, `AbsoluteTolerance` is the threshold below which you do not worry about the accuracy of the solution since it is effectively 0. `RelativeTolerance` controls the relative error of a single step of the integrator. Intuitively, it controls the number of significant digits in a solution, except when it is smaller than the absolute tolerance, and $-\log_{10}(\text{RelativeTolerance})$ is the number of correct digits.

Algorithm

At each simulation step i , the solver estimates the local error e in the state j of the simulation. The solver reduces the size of time step i until the error of the state satisfies:

$$|e(i, j)| \leq \max(\text{RelativeTolerance} * |y(i, j)|, \text{AbsoluteTolerance}(i, j))$$

Thus at state values of larger magnitude, the accuracy is determined by `RelativeTolerance`. As the state values approach zero, the accuracy is controlled by `AbsoluteTolerance`.

The correct choice of values for `RelativeTolerance` and `AbsoluteTolerance` varies depending on the problem. The default values may work for first trials of the simulation. As you adjust the tolerances, consider that there are trade-offs between speed and accuracy:

- If the simulation takes too long, you can increase (or loosen) the values of `RelativeTolerance` and `AbsoluteTolerance` at the cost of some accuracy.
- If the results seem inaccurate, you can decrease (or tighten) the relative tolerance values by dividing with 10^N , where N is a real positive number. But this tends to slow down the solver.
- If the magnitude of the state values is high, you can decrease the relative tolerance to get more accurate results.

Absolute Tolerance Scaling

How SimBiology uses `AbsoluteTolerance` to determine the error depends on whether the `AbsoluteToleranceScaling` property is enabled. By default, `AbsoluteToleranceScaling` is enabled which means each state has its own absolute tolerance that may increase over the course of simulation:

$$\text{AbsoluteTolerance}(i, j) = \text{CSAbsTol} * \text{Scale}(i, j)$$

`CSAbsTol` is the `AbsoluteTolerance` property defined in `SolverOptions` of the active configuration set object.

For a state that has a nonzero initial value, the scale is the maximum magnitude over the state, as seen over the simulation thus far:

$$Scale(i, j) = \max(|y(1:i, j)|)$$

For a state that has an initial value of zero, the scale is estimated as the state value after taking a trial step of size `AbsoluteToleranceStepSize` using the Euler method. Let us call this value `ye(j)`. Then:

$$Scale(i, j) = \max(|[ye(j); y(2:i, j)]|)$$

If an initial state is zero and has no dynamic at time = 0, then:

$$AbsoluteTolerance(i, j) = CSAbsTol$$

Doses, events, and initial assignment rules at simulation time = 0 are not considered when calculating absolute tolerance scaling.

See Also

More About

- “Model Simulation” on page 4-3
- “Choosing a Simulation Solver” on page 4-7
- “Ordinary Differential Equations”

Troubleshooting Simulation Problems

SimBiology uses ODE solvers for model simulation on page 4-3. Solver errors can cause simulation problems. Many solver errors relate to the stiffness of the model and the relative and absolute tolerances. As a result, the simulation can take long. You might also see one of the following error messages, indicating that the solver is not able to solve the problem within the tolerances.

- Integration tolerance not met
- CVODES returned -4 from module CVODES function CVode: At t = ... and h = ... the corrector convergence test failed repeatedly or with $|h| = hmin$.

You might also see one or more of the following warning messages, which are precursors to potential solver tolerance issues.

- The right-hand side of the system of SimBiology ODEs results in complex numbers. The imaginary part of the result will be ignored.
- The right-hand side of the system of SimBiology ODEs results in infinite or NaN values. This usually indicates a modeling error and can lead to solver integration errors.
- The repeated assignment rules of the SimBiology model result in complex numbers. The imaginary part of the result will be ignored.

Tips for Solving Simulation Problems

To fix the simulation problems that solver errors can cause, try the following troubleshooting tips.

Improve Performance by Acceleration

You can accelerate the simulation by converting the model to compiled C code, which executes faster. For details, see “Accelerating Model Simulations and Analyses” on page 4-85. If the simulation is still slow after acceleration, there might be solver tolerance issues. Try the remaining tips without accelerating the model.

Debug the Model Using MaximumNumberOfLogs and MaximumWallClock

MaximumNumberOfLogs and MaximumWallClock are some of the configuration options you can use to stop the simulation just before the error happens. Then you can check for unusual simulated values, such as negative species amounts.

For instance, set MaximumNumberOfLogs to 1 to get the values of the model immediately after applying initial and repeated assignment rules. If you set the value to 2, and the simulation fails with the integration error, then it probably indicates an error with the assignment rules.

While varying MaximumNumberOfLogs, simulate the model repeatedly using the same conditions that produce the error. The model might simulate without error until you reach a certain value of MaximumNumberOfLogs. Then check the simulated values at the final simulation time. If you see negative values for certain states, such as negative species amounts, examine the expressions in your model that can affect those states. Update the expressions to account for possible issues, such as negative values or division-by-0, by either rearranging the equations and/or inserting some protections, such as $\max(0, x)$ or $\max(\text{eps}, x)$, where x is the variable that is responsible for the error.

Alternatively, you can look at the model equations to check the initial conditions, such as species amounts and parameter values at simulation time = 0 to see if the values are as expected. For details, see `getequations` or “Show Model Equations and Initial Conditions” on page 1-31.

Check the ODE Solver

If your model is stiff, and you have selected an inappropriate solver, the step size taken by the solver might be forced down to an unreasonably small level compared to the interval of integration. Make sure that you have selected either `ode15s` or `sundials` as your solver for stiff ODEs.

Disable AbsoluteToleranceScaling

Turn off `AbsoluteToleranceScaling`.

SimBiology uses `AbsoluteTolerance` and `RelativeTolerance` to control the accuracy of integration during simulation. Specifically, `AbsoluteTolerance` controls the largest allowable absolute error at any step during simulation.

When `AbsoluteToleranceScaling` is enabled (by default), each state has its own absolute tolerance that can increase over the course of simulation. Sometimes the automatic scaling is inadequate for models that have kinetics at largely different scales. For example, the reaction rate of a reaction can be in the order of 10^{22} , while another is 0.1 . By turning off `AbsoluteToleranceScaling`, you might be able to simulate the model.

Loosen Tolerances

If the simulation tolerance error still exists after disabling `AbsoluteToleranceScaling`, try loosening the relative and absolute tolerances.

Set `RelativeTolerance` to 10^{-m+1} , where m is the number of significant digits desired in the solution X . If X has multiple scales, start with using the smaller X and increase from there if the tolerance is not met.

Set `AbsoluteTolerance` to a value of X that is negligibly small for your problem. Similarly, start from the smaller X and increase from there.

For details, see “Selecting Absolute Tolerance and Relative Tolerance for Simulation” on page 3-13.

Set MassUnits and AmountUnits

The `MassUnits` and `AmountUnits` properties define the appropriate mass or amount unit that SimBiology uses internally during model simulation when `UnitConversion` is on. It is recommended that you use the default unit (`<automatic>`) but in some edge cases, you may need to change it.

Change `MassUnits` or `AmountUnits` to a unit so that the simulated values are not too large (that is, greater than 10^6) or too small (that is, smaller than 10^{-6}).

Suppose that you have a model with a state that takes on values around 10^{-12} moles for the entire simulation. It might be appropriate to set `AmountUnits` to `picomole`. In this case, the internal simulation values would be around 1, instead of around 10^{-12} as in the default case.

How to Change Solver Options and Simulation Options

Solver and simulation options are stored in the configuration set object (`configset` object) of the model. Solver options contain settings such as relative and absolute tolerances. Simulation options

are settings such as `MaximumNumberOfLogs` and `MaximumWallClock`. Depending on whether you are using the command line or graphical interface, the way to access and change the options differs.

Using the Command line

To access and change the `SolverOptions`, use the following commands, where *m1* is a SimBiology model.

```
configset = getconfigset(m1);
solverOpts = configset.SolverOptions;
solverOpts.AbsoluteTolerance = 1e-5;
solverOpts.RelativeTolerance = 1e-5;
solverOpts.AbsoluteToleranceScaling = false;
```

Access simulation options directly from the `configset` object.

```
configset = getconfigset(m1);
configset.MaximumNumberOfLogs = 1;
configset.MaximumWallClock = 10;
```

Using the Graphical Interface

If you are using the **SimBiology Model Analyzer** app, you can access the options by clicking **Simulation Settings** from the **Home** tab.

See Also

`Configset` object | `SolverOptions` | `AbsoluteTolerance` | `RelativeTolerance` | `MaximumNumberOfLogs` | `MaximumWallClock` | `getequations`

More About

- “Model Simulation” on page 4-3
- “Selecting Absolute Tolerance and Relative Tolerance for Simulation” on page 3-13
- “Show Model Equations and Initial Conditions” on page 1-31

Simulate Model of Glucose-Insulin Response with Different Initial Conditions

This example shows how to simulate the glucose-insulin responses for the normal and diabetic subjects.

Load the model of glucose-insulin response. For details about the model, see the **Background** section in “Simulating the Glucose-Insulin Response” on page 4-166.

```
sbioloadproject('insulindemo', 'm1')
```

The model contains different initial conditions stored in various variants.

```
variants = getvariant(m1);
```

Get the initial conditions for the type 2 diabetic patient.

```
type2 = variants(1)
```

```
type2 =  
    SimBiology Variant - Type 2 diabetic (inactive)
```

ContentIndex:	Type:	Name:	Property:	Value:
1	parameter	Plasma Volume ...	Value	1.49
2	parameter	k1	Value	0.042
3	parameter	k2	Value	0.071
4	parameter	Plasma Volume ...	Value	0.04
5	parameter	m1	Value	0.379
6	parameter	m2	Value	0.673
7	parameter	m4	Value	0.269
8	parameter	m5	Value	0.0526
9	parameter	m6	Value	0.8118
10	parameter	Hepatic Extrac...	Value	0.6
11	parameter	kmax	Value	0.0465
12	parameter	kmin	Value	0.0076
13	parameter	kabs	Value	0.023
14	parameter	kgri	Value	0.0465
15	parameter	f	Value	0.9
16	parameter	a	Value	6e-05
17	parameter	b	Value	0.68
18	parameter	c	Value	0.00023
19	parameter	d	Value	0.09
20	parameter	kp1	Value	3.09
21	parameter	kp2	Value	0.0007
22	parameter	kp3	Value	0.005
23	parameter	kp4	Value	0.0786
24	parameter	ki	Value	0.0066
25	parameter	[Ins Ind Glu U...	Value	1
26	parameter	Vm0	Value	4.65
27	parameter	Vmx	Value	0.034
28	parameter	Km	Value	466.21
29	parameter	p2U	Value	0.084
30	parameter	K	Value	0.99
31	parameter	alpha	Value	0.013
32	parameter	beta	Value	0.05
33	parameter	gamma	Value	0.5
34	parameter	ke1	Value	0.0007

35	parameter	ke2	Value	269
36	parameter	Basal Plasma G...	Value	164.18
37	parameter	Basal Plasma I...	Value	54.81

Suppress an informational warning that is issued during simulations.

```
warnSettings = warning('off', 'SimBiology:DimAnalysisNotDone_MatlabFcn_Dimensionless');
```

Create SimFunction objects to simulate the glucose-insulin response for the normal and diabetic subjects.

- Specify an empty array {} for the second input argument to denote that the model will be simulated using the base parameter values (that is, no parameter scanning will be performed).
- Specify the plasma glucose and insulin concentrations as responses (outputs of the function to be plotted).
- Specify the species Dose as the dosed species. This species represents the initial concentration of glucose at the start of the simulation.

```
normSim = createSimFunction(m1, {}, ...
    {'[Plasma Glu Conc]', '[Plasma Ins Conc]'}, 'Dose')
```

```
normSim =
SimFunction
```

Parameters:

Observables:

Name	Type	Units
{'[Plasma Glu Conc]}'	{'species'}	{'milligram/deciliter'}
{'[Plasma Ins Conc]}'	{'species'}	{'picomole/liter' }

Dosed:

TargetName	TargetDimension
{'Dose'}	{'Mass (e.g., gram)'}

TimeUnits: hour

For the diabetic patient, specify the initial conditions using the variant type2.

```
diabSim = createSimFunction(m1, {}, ...
    {'[Plasma Glu Conc]', '[Plasma Ins Conc]'}, 'Dose', type2)
```

```
diabSim =
SimFunction
```

Parameters:

Observables:

Name	Type	Units
{' [Plasma Glu Conc] '}	{'species'}	{'milligram/deciliter'}
{' [Plasma Ins Conc] '}	{'species'}	{'picomole/liter' }

Dosed:

TargetName	TargetDimension
{'Dose'}	{'Mass (e.g., gram)'}

TimeUnits: hour

Select a dose that represents a single meal of 78 grams of glucose at the start of the simulation.

```
singleMeal = sbioselect(m1, 'Name', 'Single Meal');
```

Convert the dosing information to the table format.

```
mealTable = getTable(singleMeal);
```

Simulate the glucose-insulin response for a normal subject for 24 hours.

```
sbioplot(normSim([], 24, mealTable));
```

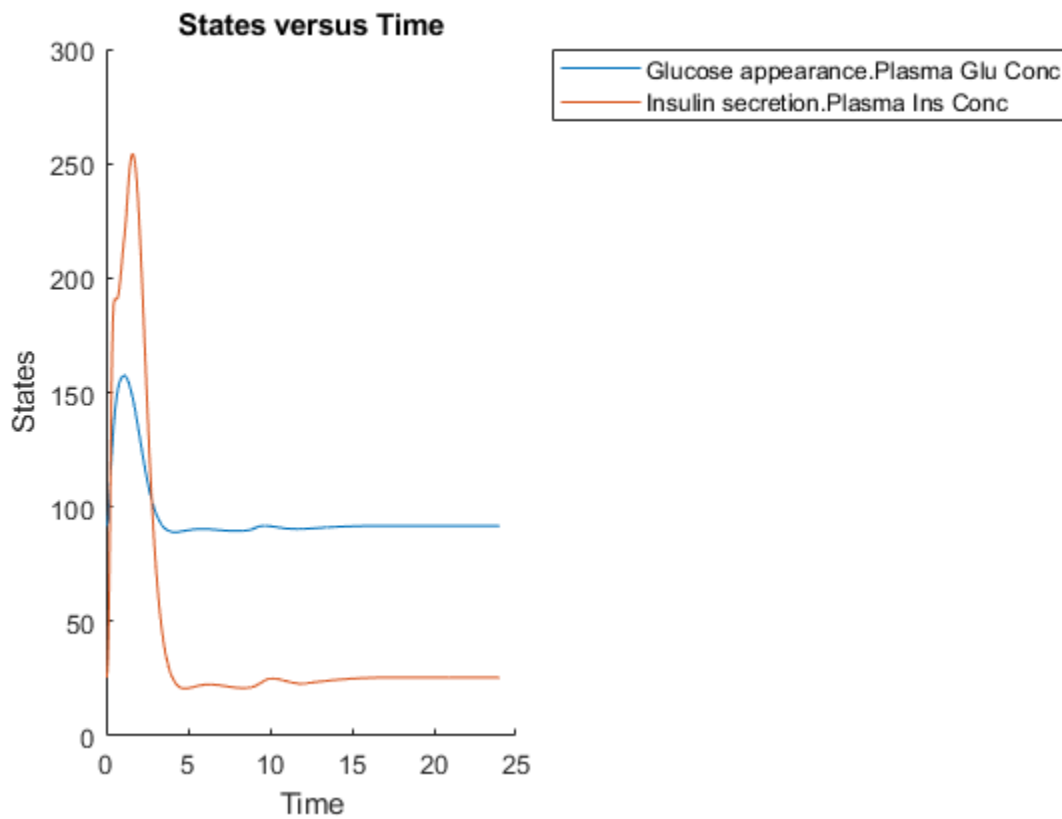

Simulate the glucose-insulin response for a diabetic subject for 24 hours.

```
sbioplot(diabSim([],24,mealTable));
```

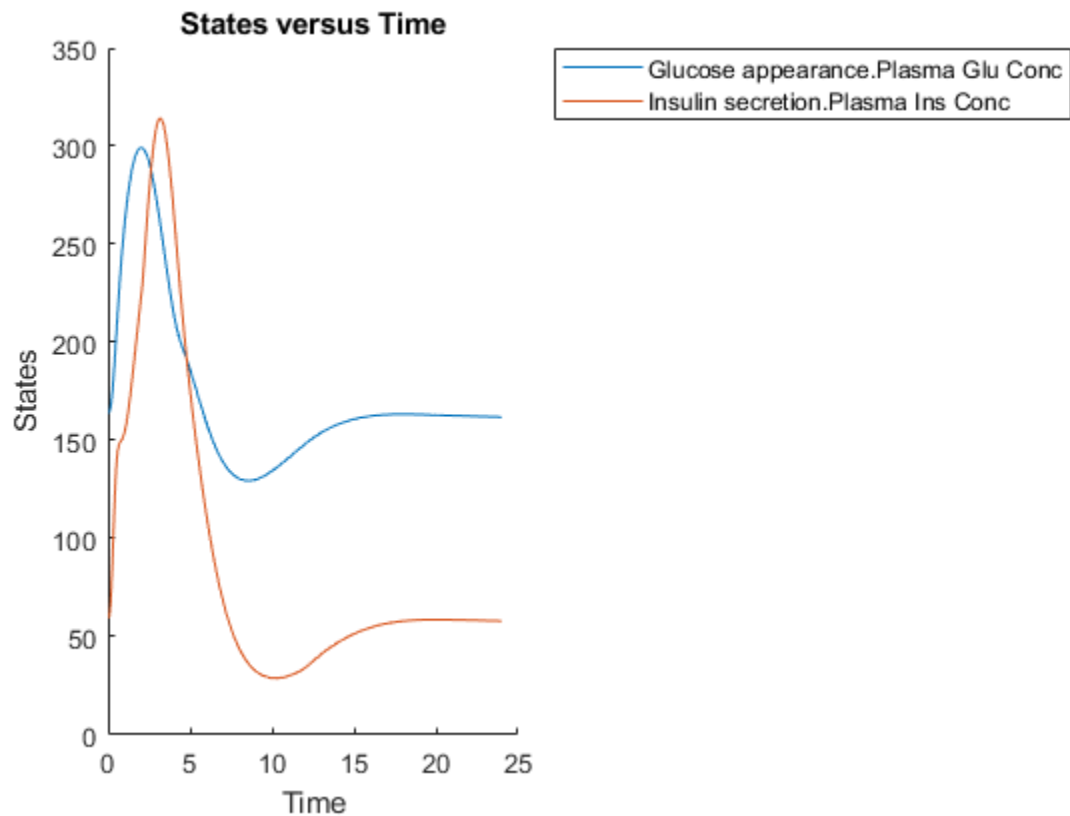

Perform a Scan Using Variants

Suppose you want to perform a parameter scan using an array of variants that contain different initial conditions for different insulin impairments. For example, the model `m1` has variants that correspond to the low insulin sensitivity and high insulin sensitivity. You can simulate the model for both conditions via a single call to the `SimFunction` object.

Select the variants to scan.

```
varToScan = sbioselect(m1, 'Name', ...
    {'Low insulin sensitivity', 'High insulin sensitivity'});
```

Check which model parameters are being stored in each variant.

```
varToScan(1)
```

```
ans =
    SimBiology Variant - Low insulin sensitivity (inactive)

    ContentIndex:    Type:        Name:        Property:    Value:
    1                parameter  Vmx         Value       0.0235
    2                parameter  kp3        Value       0.0045
```

```
varToScan(2)
```

```
ans =
  SimBiology Variant - High insulin sensitivity (inactive)

  ContentIndex:   Type:      Name:      Property:   Value:
  1               parameter Vmx       Value      0.094
  2               parameter kp3      Value      0.018
```

Both variants store alternate values for `Vmx` and `kp3` parameters. You need to specify them as input parameters when you create a `SimFunction` object.

Create a `SimFunction` object to scan the variants.

```
variantScan = createSimFunction(m1,{'Vmx','kp3'},...
    {'[Plasma Glu Conc]','[Plasma Ins Conc]'},'Dose');
```

Simulate the model and plot the results. Run 1 include simulation results for the low insulin sensitivity and Run 2 for the high insulin sensitivity.

```
sbioplot(variantScan(varToScan,24,mealTable));
```

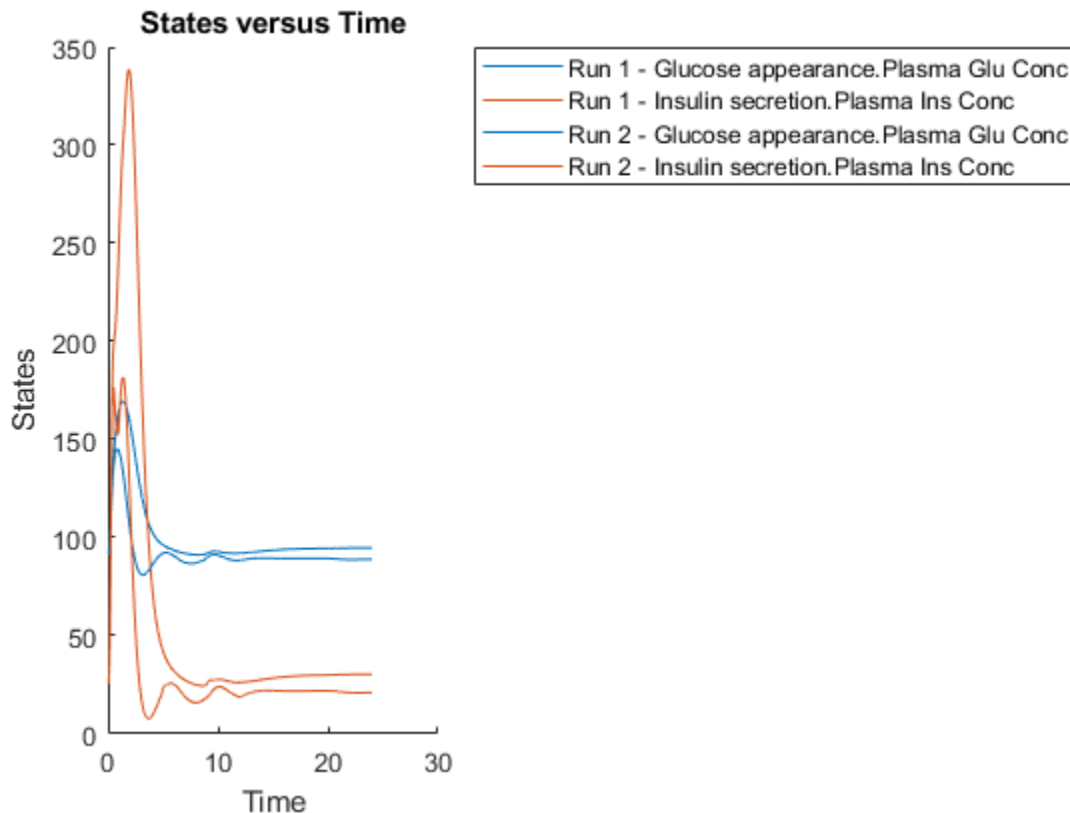

Low insulin sensitivity lead to increased and prolonged plasma glucose concentration.

Restore warning settings.

```
warning(warnSettings);
```

Combine Simulation Scenarios in SimBiology

There are two different methods to combine SimBiology simulation scenarios that have different doses, different variants, or different sample values for model quantities. After the combination, you get a final set of values (parameter set) that you can use to simulate and explore the model behavior. For instance, you can combine different dosing regimens with different categories of patients (variants) and simulate to explore the efficacy of the drug.

Cartesian Combination

This method is the Cartesian product of two sets. Suppose *doses* is a set of different RepeaDose objects [d1, d2, d3], and *variants* is a set of variant objects: [v1, v2, v3]. The Cartesian combination of *doses* and *variants* is: $doses \times variants = (d1, v1), (d2, v1), (d3, v1), (d1, v2), (d2, v2), (d3, v2), (d1, v3), (d2, v3), (d3, v3)$.

doses x variants =

<i>doses</i> \ <i>variants</i>	v1	v2	v3
d1	d1,v1	d1,v2	d1,v3
d2	d2,v1	d2,v2	d2,v3
d3	d3,v1	d3,v2	d3,v3

Elementwise Combination

This combination method combines the entries one to one, that is, elementwise. In other words, the first element of the first set (entry) is combined with the first element of the second set (entry) and so on. Using the same variables above, the *elementwise* combination of *doses* and *variants* is: $doses + variants = (d1, v1), (d2, v2), (d3, v3)$. Both sets must have the same number of elements (samples) for this combination method.

doses + variants =

<i>doses</i>	<i>variants</i>
d1,	v1
d2,	v2
d3,	v3

See Also

SimBiology.Scenarios

More About

- “SimBiology.Scenarios Terminology”

Simulation and Analysis

- “Model Simulation” on page 4-3
- “Deriving ODEs from Reactions” on page 4-5
- “Choosing a Simulation Solver” on page 4-7
- “SUNDIALS Solvers” on page 4-8
- “Stochastic Solvers” on page 4-9
- “Ensemble Runs of Stochastic Simulations” on page 4-12
- “Configuring Simulation Settings” on page 4-13
- “Simulate the Yeast Heterotrimeric G Protein Cycle” on page 4-14
- “Sensitivity Analysis in SimBiology” on page 4-19
- “Calculate Sensitivities Using sbiosimulate” on page 4-24
- “Perform a Parameter Scan” on page 4-27
- “Nonlinear Mixed-Effects Modeling” on page 4-29
- “Nonlinear Regression” on page 4-35
- “Supported Methods for Parameter Estimation in SimBiology” on page 4-42
- “Error Models” on page 4-44
- “Progress Plot” on page 4-45
- “Fit One-Compartment Model to Individual PK Profile” on page 4-52
- “Estimate Category-Specific PK Parameters for Multiple Individuals” on page 4-58
- “Perform Hybrid Optimization Using sbiofit” on page 4-67
- “Fit a Two-Compartment Model to PK Profiles of Multiple Individuals” on page 4-71
- “Estimating the Bioavailability of a Drug” on page 4-78
- “Accelerating Model Simulations and Analyses” on page 4-85
- “Noncompartmental Analysis” on page 4-88
- “Stochastic Simulation of Radioactive Decay” on page 4-95
- “Stochastic Simulation of the Lotka-Volterra Reactions” on page 4-100
- “Comparing SSA and Explicit Tau-Leaping Stochastic Solvers” on page 4-105
- “Deterministic Simulation of a Model Containing a Discontinuity” on page 4-109
- “Analysis of Stochastic Ensemble Data in SimBiology” on page 4-113
- “Deploy a SimBiology Model Using SimFunction” on page 4-122
- “Deploy a SimBiology Exported Model” on page 4-125
- “Parameter Scanning, Parameter Estimation, and Sensitivity Analysis in the Yeast Heterotrimeric G Protein Cycle” on page 4-127
- “Finding Conserved Quantities in a Pathway Model” on page 4-145
- “Modeling the Population Pharmacokinetics of Phenobarbital in Neonates” on page 4-153
- “Simulating the Glucose-Insulin Response” on page 4-166

- “PK/PD Modeling and Simulation to Guide Dosing Strategy for Antibiotics” on page 4-183
- “Fit PK Parameters Using SimBiology Problem-Based Workflow” on page 4-193

Model Simulation

SimBiology lets you simulate the dynamic behavior of a model. Before and during simulation, SimBiology performs a series of steps including converting the model reactions and rate rules into a set of ordinary differential equations (ODEs) that mathematically describe the model dynamics.

Specifically, before simulation begins, SimBiology:

- 1 Verifies the model. For details, see “Model Verification” on page 3-2.
- 2 Determines the initial conditions, that is, the quantity values at the beginning of simulation. In particular, SimBiology first initializes the quantity values based on the values specified in the model. Second, it updates the values by replacing them with the corresponding alternate values from variants if any. Then it updates the values based on the initial assignments and repeated assignments. SimBiology evaluates initial assignments and repeated assignments as a set of simultaneous constraints, and their order do not affect the final quantity values. For details, see “Evaluation Order of Rules” on page 2-15.
- 3 Constructs the ODEs based on model reactions and rate rules. Specifically, the left-hand-side (LHS) of each ODE represents the time-derivative of a model quantity. The right-hand-side (RHS) is defined using reaction fluxes that are derived from reaction rates. For details, see “Deriving ODEs from Reactions” on page 4-5.
- 4 Converts doses to state transitions that occur at specific simulation times.
- 5 Converts event functions to state transitions that depend on the conditions specified in the event triggers.

When the simulation begins, that is, at simulation time = 0, SimBiology:

- 1 Updates values based on initial assignments and repeated assignments.
- 2 Applies any state transitions due to dosing specified at simulation time = 0.
- 3 Logs the updated quantity values.

Note Events cannot cause transitions at time = 0 since events only apply when a trigger changes from false to true. If a trigger is true at simulation time = 0, then no transition has occurred and the event is not triggered.

During the simulation, SimBiology uses a solver to compute solutions for ODEs at different times. Specifically, the solver determines appropriate time steps and performs the following at each step.

- 1 Updates values for any repeated assignments.
- 2 Checks each event’s trigger condition. If it switches from false to true at this time step, then it applies the state transitions according to the event functions, and updates values for any repeated assignments.
- 3 Logs the updated quantity values.

To see the system of ODEs of a model, use `getequations` at the command line or follow instructions in “Show Model Equations and Initial Conditions” on page 1-31 for the **SimBiology Model Builder** app.

Note If a model has algebraic equations, you must specify one of the following differential-algebraic-equation (DAE) solvers: `sundials`, `ode15s`, `ode23t`. SimBiology converts the algebraic equations to

algebraic constraints and solves them along with the rest of ODEs. For details about available solvers, see “Choosing a Simulation Solver” on page 4-7.

See Also

getequations

Related Examples

- “Show Model Equations and Initial Conditions” on page 1-31
- “Simulate the Yeast Heterotrimeric G Protein Cycle” on page 4-14

More About

- “Simulation”
- “Choosing a Simulation Solver” on page 4-7
- “Configuring Simulation Settings” on page 4-13
- “Conservation of Amounts During Simulation” on page 2-15

Deriving ODEs from Reactions

For model simulation, SimBiology derives ordinary differential equations (ODEs) from model reactions using mass-balance principles. The left-hand-side (LHS) of each ODE is the time-derivative of a model quantity and the right-hand-side (RHS) is defined using reaction fluxes that are derived from reaction rates and rate rules. In other words, SimBiology represents a system of ODEs as follows.

$$\dot{x} = S \cdot v$$

\dot{x} is an M -by-1 vector containing the rates of change for model quantities, S is an M -by- R stoichiometry matrix on page 3-11, v is an R -by-1 flux vector. M equals the total number of species, and R equals the total number of reactions in the model

During the conversion of model reactions into ODEs, SimBiology performs a dimensional analysis to ensure each reaction flux has the dimension of `substance/time` such as `amount/time` or `mass/time`. If the reaction rate has the dimension of `concentration/time`, then SimBiology multiplies it by the compartment volume to get the reaction flux. If the reaction rate has the dimension of `substance/time`, then the flux is identical to the rate, and no volume-correction is performed. If there are no units specified with the model, the default dimension for a species (`DefaultSpeciesDimension`) is `concentration`, and that for a flux is `substance/time`. For such cases, the ODE is the flux divided by a compartment volume to make the dimension of LHS and RHS consistent. See the following figure for an illustration.

Suppose there is a reaction $x \rightarrow y$, with the reaction rate $R1$. The following figure explains the dimensional analysis performed by SimBiology to make the dimensions of LHS and RHS of an ODE consistent.

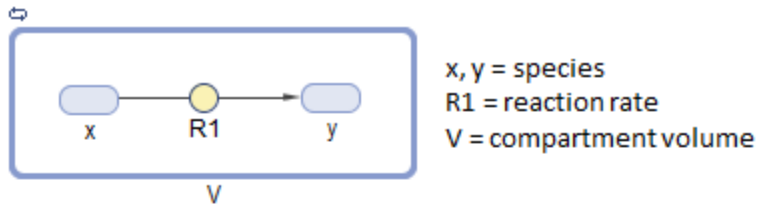
**Flux**

If the dimension of the reaction rate $R1$ is *substance/time*, then:

$$flux = R1$$

If the dimension of $R1$ is *concentration/time*, then:

$$flux = R1 \cdot V$$

ODE

If the dimension of species is *substance*, then:

$$\frac{dx}{dt} = -flux$$

If the dimension of species is *concentration*, then:

$$\frac{dx}{dt} = (-flux) \cdot 1/V$$

See Also

getstoichmatrix (model)

More About

- “Model Simulation” on page 4-3
- “Conservation of Amounts During Simulation” on page 2-15
- “Determining the Stoichiometry Matrix for a Model” on page 3-11

Choosing a Simulation Solver

To simulate a model, the SimBiology software converts a model to a system of differential equations. It then uses a solver function to compute solutions for these equations at different time intervals, giving the model's states and outputs over a span of time.

Available solvers are:

- **ODE Solvers** — These include Nonstiff Deterministic Solvers and Stiff Deterministic Solvers. The solver functions implement numerical integration methods for solving initial value problems for ordinary differential equations (ODEs). Beginning at the initial time with initial conditions, they step through the time interval, computing a solution at each time step. If the solution for a time step satisfies the solver's error tolerance criteria, it is a successful step. Otherwise, it is a failed attempt; the solver shrinks the step size and tries again. For more information, see ODE Solvers.
- **SUNDIALS Solvers** — At a fundamental level the core algorithms for the SUNDIALS solvers are similar to those for some of the solvers in the MATLAB ODE suite and work as described above in ODE Solvers. SimBiology always uses the SUNDIALS solver to perform sensitivity analysis on a model, regardless of what you have selected as the SolverType. For more information, see “SUNDIALS Solvers” on page 4-8.
- **Stochastic Solvers** — Use with models containing a small number of molecules. Stochastic solvers include stochastic simulation algorithm, explicit tau-leaping algorithm, and implicit tau-leaping algorithm. For more information, see “Stochastic Solvers” on page 4-9.

See Also

Related Examples

- “Simulate the Yeast Heterotrimeric G Protein Cycle” on page 4-14

More About

- “Model Simulation” on page 4-3
- ODE Solvers
- “SUNDIALS Solvers” on page 4-8
- “Stochastic Solvers” on page 4-9

SUNDIALS Solvers

SUNDIALS (Suite of Nonlinear and Differential/Algebraic Equation Solvers) are part of a freely available third-party package developed at Lawrence Livermore National Laboratory. All other ODE solvers used for simulation of SimBiology models, such as `ode45` and `ode15s`, are part of the MATLAB ODE suite. SimBiology currently (R2022a or later) uses SUNDIALS 5.7.0.

SimBiology always uses the SUNDIALS solver to perform sensitivity analysis on a model, regardless of what you have selected as the `SolverType` in the configuration set.

In addition, if you are estimating model parameters using `sbiofit` or the Fit Data program with one of these gradient-based estimation functions: `fmincon`, `fminunc`, `lsqnonlin`, or `lsqcurvefit`, SimBiology uses the SUNDIALS solver by default to calculate sensitivities and use them to improve fitting. If you are using `sbiofit`, you can turn off this sensitivity calculation feature by setting the “SensitivityAnalysis” name-value pair argument to `false`. However, if you are using the Fit Data program, you cannot turn off this feature. It is recommended that you keep the sensitivity analysis feature on whenever possible for more accurate gradient approximations and better parameter fits.

When you specify `sundials` for the solver, the software chooses one of two SUNDIALS solvers, CVODE or IDA, as appropriate for your model:

- **CVODE** is a solver for systems of ODEs, both nonstiff and stiff. This is used when a model has no algebraic rules.
- **IDA** is a differential-algebraic equation (DAE) solver, used when one or more algebraic rules are present.

For more information on the SUNDIALS solvers, see <https://www.llnl.gov/casc/sundials/description/description.html>.

See Also

More About

- “Model Simulation” on page 4-3
- ODE Solvers
- “Stochastic Solvers” on page 4-9

Stochastic Solvers

In this section...

“When to Use Stochastic Solvers” on page 4-9
 “Model Prerequisites for Simulating with a Stochastic Solver” on page 4-9
 “What Happens During a Stochastic Simulation?” on page 4-9
 “Stochastic Simulation Algorithm (SSA)” on page 4-9
 “Explicit Tau-Leaping Algorithm” on page 4-10
 “Implicit Tau-Leaping Algorithm” on page 4-10
 “References” on page 4-11

When to Use Stochastic Solvers

The stochastic simulation algorithms provide a practical method for simulating reactions that are stochastic in nature. Models with a small number of molecules can realistically be simulated stochastically, that is, allowing the results to contain an element of probability, unlike a deterministic solution.

Model Prerequisites for Simulating with a Stochastic Solver

Model prerequisites include:

- All reactions in the model must have their `KineticLaw` property set to `MassAction`.
- If your model contains events, you can simulate using the stochastic `ssa` solver. Other stochastic solvers do not support events.
- Your model must not contain doses. No stochastic solvers support doses.

Additionally, if you perform an individual or population fitting on a model whose `Configset` object specifies a stochastic solver and options, be aware that during the fitting SimBiology temporarily changes:

- `SolverType` property to the default solver of `ode15s`
- `SolverOptions` property to the options last configured for a deterministic solver

What Happens During a Stochastic Simulation?

During a stochastic simulation of a model, the software ignores any rate, assignment, or algebraic rules if present in the model. Depending on the model, stochastic simulations can require more computation time than deterministic simulations.

Tip When simulating a model using a stochastic solver, you can increase the `LogDecimation` property of the `configset` object to record fewer data points and decrease run time.

Stochastic Simulation Algorithm (SSA)

The Chemical Master Equation (CME) describes the dynamics of a chemical system in terms of the time evolution of probability distributions. Directly solving for this distribution is impractical for most

realistic problems. The stochastic simulation algorithm (SSA) instead efficiently generates individual simulations that are consistent with the CME, by simulating each reaction using its propensity function. Thus, analyzing multiple stochastic simulations to determine the probability distribution is more efficient than directly solving the CME.

Advantage

- This algorithm is exact.

Disadvantages

- Because this algorithm evaluates one reaction at a time, it might be too slow for models with a large number of reactions.
- If the number of molecules of any reactants is huge, it might take a long time to complete the simulation.

Explicit Tau-Leaping Algorithm

Because the stochastic simulation algorithm might be too slow for many practical problems, this algorithm was designed to speed up the simulation at the cost of some accuracy. The algorithm treats each reaction as being independent of the others. It automatically chooses a time interval such that the relative change in the propensity function for each reaction is less than your error tolerance. After selecting the time interval, the algorithm computes the number of times each reaction occurs during the time interval and makes the appropriate changes to the concentration of various chemical species involved.

Advantages

- This algorithm can be orders of magnitude faster than the SSA.
- You can use this algorithm for large problems (if the problem is not numerically stiff).

Disadvantages

- This algorithm sacrifices some accuracy for speed.
- This algorithm is not good for stiff models.
- You need to specify the error tolerance so that the resulting time steps are of the order of the fastest time scale.

Implicit Tau-Leaping Algorithm

Like the explicit tau-leaping algorithm, the implicit tau-leaping algorithm is also an approximate method of simulation designed to speed up the simulation at the cost of some accuracy. It can handle numerically stiff problems better than the explicit tau-leaping algorithm. For deterministic systems, a problem is said to be numerically stiff if there are “fast” and “slow” time scales present in the system. For such problems, the explicit tau-leaping method performs well only if it continues to take small time steps that are of the order of the fastest time scale. The implicit tau-leaping method can potentially take much larger steps and still be stable. The algorithm treats each reaction as being independent of others. It automatically selects a time interval such that the relative change in the propensity function for each reaction is less than the user-specified error tolerance. After selecting a time interval, the algorithm computes the number of times each reaction occurs during the time interval and makes the appropriate changes to the concentration of various chemical species involved.

Advantages

- This algorithm can be much faster than the SSA. It is also usually faster than the explicit tau-leaping algorithm.
- You can use this algorithm for large problems and also for numerically stiff problems.
- The total number of steps taken is usually less than the explicit-tau-leaping algorithm.

Disadvantages

- This algorithm sacrifices some accuracy for speed.
- There is a higher computational burden for each step as compared to the explicit tau-leaping algorithm. This leads to a larger CPU time per step.
- This method often dampens perturbations of the slow manifold leading to a reduced state variance about the mean.

References

- [1] Gibson M.A., Bruck J. (2000), "Exact Stochastic Simulation of Chemical Systems with Many Species and Many Channels," *Journal of Physical Chemistry*, 105:1876-1899.
- [2] Gillespie D. (1977), "Exact Stochastic Simulation of Coupled Chemical Reactions," *The Journal of Physical Chemistry*, 81(25): 2340-2361.
- [3] Gillespie D. (2000), "The Chemical Langevin Equation," *Journal of Chemical Physics*, 113(1): 297-306.
- [4] Gillespie D. (2001), "Approximate Accelerated Stochastic Simulation of Chemically Reacting Systems," *Journal of Chemical Physics*, 115(4):1716-1733.
- [5] Gillespie D., Petzold L. (2004), "Improved Leap-Size Selection for Accelerated Stochastic Simulation," *Journal of Chemical Physics*, 119:8229-8234
- [6] Rathinam M., Petzold L., Cao Y., Gillespie D. (2003), "Stiffness in Stochastic Chemically Reacting Systems: The Implicit Tau-Leaping Method," *Journal of Chemical Physics*, 119(24):12784-12794.
- [7] Moler, C. (2003), "Stiff Differential Equations Stiffness is a subtle, difficult, and important concept in the numerical solution of ordinary differential equations," *MATLAB News & Notes*.

See Also

Related Examples

- "Analysis of Stochastic Ensemble Data in SimBiology" on page 4-113

More About

- "Ensemble Runs of Stochastic Simulations" on page 4-12
- "Model Simulation" on page 4-3
- "Choosing a Simulation Solver" on page 4-7

Ensemble Runs of Stochastic Simulations

Because stochastic simulations rely on an element of probability, sequential runs produce different results. Therefore, multiple stochastic runs are needed to determine the probability distribution of the simulation results.

Ensemble runs perform multiple simulations of a model using a stochastic solver. They let you gather data from multiple stochastic runs of the model so you can compare and analyze fluctuations in the behavior of a model over repeated stochastic simulations.

Running Ensemble Simulations

The following functions let you perform and analyze ensemble runs at the command line:

- `sbioensemblerrun` — Perform a stochastic ensemble run of the MATLAB model object.
- `sbioensembleplot` — Show a 2-D distribution plot or a 3-D shaded plot of the time varying distribution of one or more specified species.
- `sbioensemblestats` — Get mean and variance as a function of time for all the species in the model used to generate ensemble data by running `sbioensemblerrun`.

See Also

More About

- “Stochastic Solvers” on page 4-9
- “Model Simulation” on page 4-3
- “Choosing a Simulation Solver” on page 4-7

Configuring Simulation Settings

A model has a configuration set (`Configset` object) associated with it to control the simulation. You can edit the properties of a `Configset` object to control all aspects of the simulation, including:

- Stop time (`StopTime`, `MaximumNumberOfLogs`, and `MaximumWallClock` properties)
- Time units (`TimeUnits` property)
- Solver and error tolerances (`SolverType` and `SolverOptions` properties)
- Maximum time step size (`MaxStep` property)
- Data to record (`RuntimeOptions` property)
- Frequency of data recording (`OutputTimes` and `LogDecimation` properties)
- Sensitivity analysis (`SensitivityAnalysisOptions` and `SolverOptions` properties)
- Dimensional analysis and unit conversion (`CompileOptions` property)

To view the `Configset` object, provide the `model` object as an input argument to the `getConfigset` method.

To edit the properties of a `Configset` object, use the `set` method.

For more information on viewing and editing the stop time and other simulation settings, see “Simulate the Yeast Heterotrimeric G Protein Cycle” on page 4-14.

See Also

More About

- “Model Simulation” on page 4-3

Simulate the Yeast Heterotrimeric G Protein Cycle

This example shows how to configure simulation settings, add an event to the model to trigger a time-based change, save, and plot the simulation results. This example uses the model described in “Model of the Yeast Heterotrimeric G Protein Cycle” on page B-14 to illustrate model simulation.

Load the `gprotein.sbproj` project, which includes the variable `m1`, a SimBiology model object.

```
sbioloadproject gprotein
```

Set the simulation solver to `ode15s` and set a stop time of 500 by editing the `SolverType` and `StopTime` properties of the `configset` object associated with the `m1` model.

```
csObj = getConfigset(m1);  
csObj.SolverType = 'ode15s';  
csObj.StopTime = 500;
```

Specify to log simulation results of all species.

```
csObj.RuntimeOptions.StatesToLog = 'all';
```

Suppose the amount of the ligand species `L` is 0 at the start of the simulation, but it increases to a particular amount at time = 100. Use `sbioselect` to select the species named `L` and set its initial amount to 0. Use `addevent` to set up the desired event.

```
speciesObj = sbioselect(m1, 'Type', 'species', 'Name', 'L');  
speciesObj.InitialAmount = 0;  
evt = addevent(m1, 'time >= 100', 'L = 6.022E17');
```

Simulate the model.

```
[t,x,names] = sbiosimulate(m1);
```

Simulate the simulation results. Notice that the species `L` amount increases when the event is triggered at simulation time 100. Changes in other species do not show up in the plot due to the wide range in species amounts.

```
plot(t,x);  
legend(names)  
xlabel('Time');  
ylabel('Amount');
```

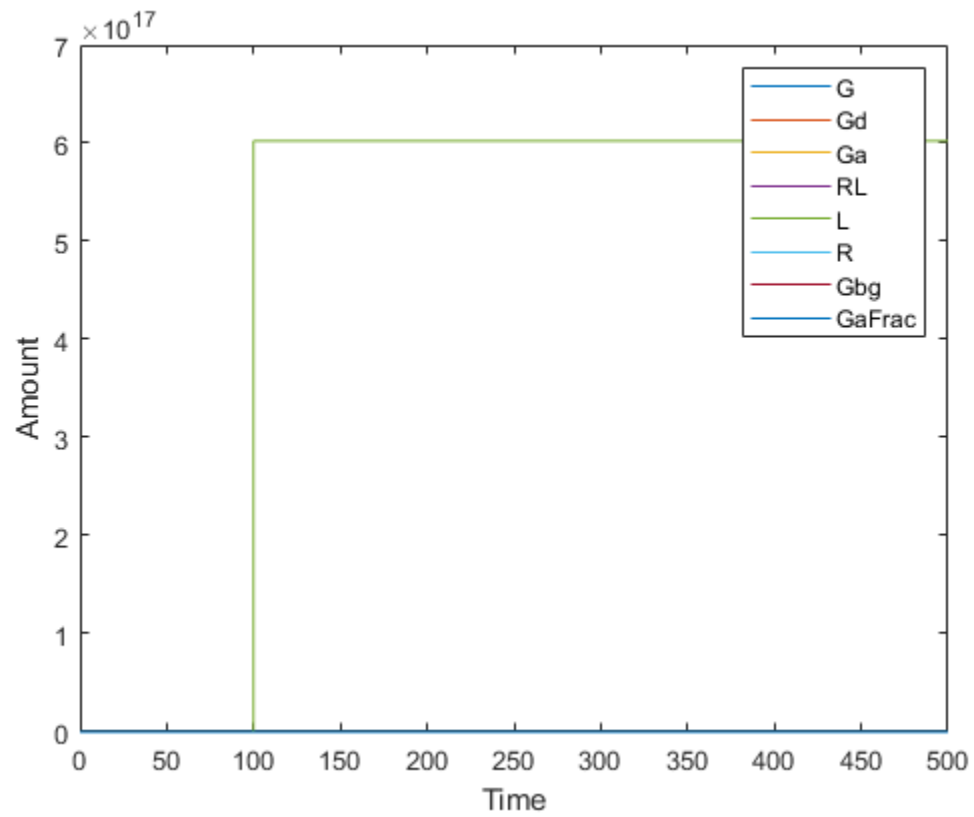

To see the changes of other species, plot without the species L (the 5th species) data.

```
figure
plot(t,x(:,[1:4 6:8]));
legend(names{[1:4 6:8]});
xlabel('Time');
ylabel('Amount');
```

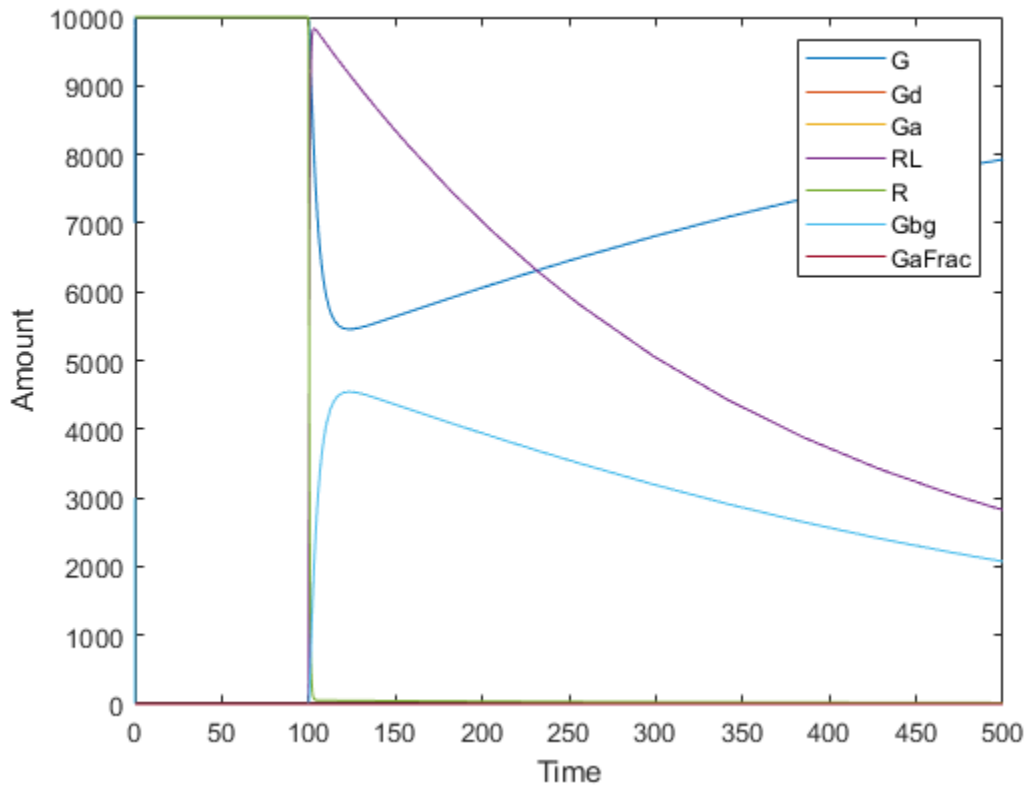

Alternative to storing simulation data in separate outputs, such as `t`, `x`, and names as above, you can store them all in a single `SimData` object. You can then use `selectbyname` to extract arrays containing the simulation data of your interest.

```
simdata = sbiosimulate(m1);  
sbioplot(simdata);
```

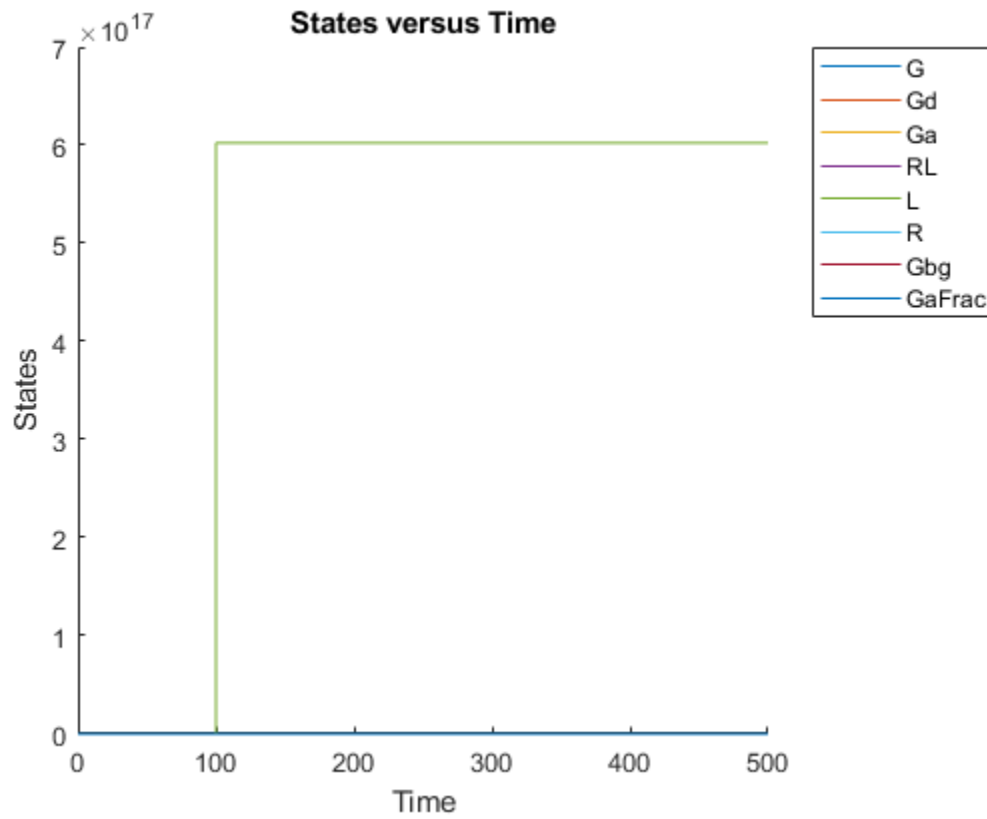

Expand **Run 1** to see the names of species and parameter that are plotted.

```
simdata_noL = selectbyname(simdata, {'Ga', 'G', 'Gd', 'GaFrac', 'RL', 'R'});  
sbioplot(simdata_noL);
```

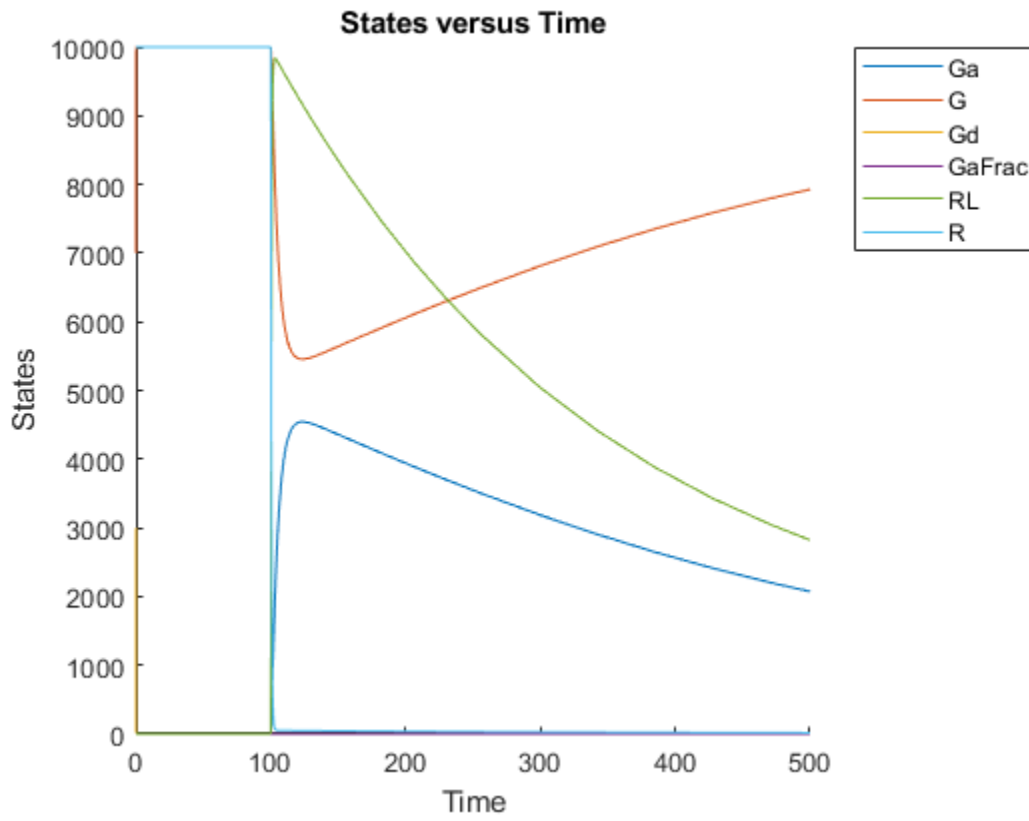

Sensitivity Analysis in SimBiology

In this section...

“Sensitivity Analysis” on page 4-19

“Global Sensitivity Analysis (GSA)” on page 4-19

“Comparison of GSA Functions” on page 4-20

“Local Sensitivity Analysis (LSA)” on page 4-21

Sensitivity Analysis

Sensitivity analysis lets you explore the effects of variations in model quantities (species, compartments, and parameters) on a model response. You can use the analysis to validate preexisting knowledge or assumption about influential model quantities on a model response or to find such quantities. You can use the information from sensitivity analysis for decision making, designing experiments, and parameter estimation. SimBiology supports two types of sensitivity analyses: local sensitivity analysis and global sensitivity analysis.

Global sensitivity analysis uses Monte Carlo simulations, where a representative (*global*) set of parameter sample values are used to explore the effects of variations in model parameters of interest on the model response. GSA provides insights into relative contributions of individual parameters that contribute most to the overall model behavior.

On the other hand, local sensitivity analysis is derivative based. This technique analyzes the effect of one model parameter at a time, keeping the other parameters fixed. Local sensitivities are dependent on a specific choice of parameter values at a time point where the analysis is performed and do not capture how parameters interact with each other during simulation when they are varied jointly.

Global Sensitivity Analysis (GSA)

In GSA, model quantities are varied together to simultaneously evaluate the relative contributions of each quantity with respect to a model response. SimBiology provides the following features to perform GSA.

Sobol Indices

In this approach, SimBiology performs a decomposition of the model output (response) variance by calculating the first- and total-order Sobol indices [1]. The first-order Sobol indices give the fractions of the overall response variance that can be attributed to variations in an input parameter alone. The total-order Sobol index gives the fraction of the overall response variance that can be attributed to joint parameter variations. For details, see “Saltelli Method to Compute Sobol Indices”.

Use `sbiosobol` to compute the Sobol indices. The function requires Statistics and Machine Learning Toolbox.

Multiparametric GSA (MPGSA)

MPGSA lets you study the relative importance of parameters with respect to a classifier defined by model responses. SimBiology implements the MPSA method proposed by Tiemann et al. [2]. For details, see “Multiparametric Global Sensitivity Analysis (MPGSA)”.

Use `sbionmpgsa` to perform MPGSA. The function requires Statistics and Machine Learning Toolbox.

Elementary Effects

`sbioelementaryeffects` lets you assess the global sensitivity of a model response with respect to variations in model parameters by computing the means and standard deviations of the elementary effects of input parameters. An elementary effect (*EE*) of an input parameter *P* with respect to a model response *R* is defined as: $EE_P(x) = R(x) - R(x + \text{delta})$.

Here, $EE_P(x)$ is the elementary effect of *P*. $R(x)$ and $R(x + \text{delta})$ are model responses at specific time or the value of an observable, evaluated for parameter values x and $x + \text{delta}$. For details, see “Elementary Effects for Global Sensitivity Analysis”.

Comparison of GSA Functions

GS A Fun cti on	Sensitivity Measure	Considerations
<code>sbiosobol</code>	It computes the fractions of total variance of a model response (sensitivity output) that can be attributed to individual model parameters (sensitivity inputs).	<ul style="list-style-type: none"> Variance-based method Supports different distributions for sensitivity inputs Computationally expensive because a large number of samples may be required to achieve convergence
<code>sbioimpgsa</code>	<p>It answers the question of whether variations in a model parameter (sensitivity input) have an influence on answering a modeling question. For example, the question might be: does a model parameter have an effect on the model response exceeding or falling below a target threshold?</p> <p>You can define such a question using a mathematical expression (classifier). For example, the following classifier defines an exposure (area under the curve) threshold for the target occupancy <i>T0</i>: <code>trapz(time, T0) <= 0.1</code>. <code>sbioimpgsa</code> reports the difference between the distributions of samples that are accepted or rejected by the classifier.</p>	<ul style="list-style-type: none"> Distribution-based method Requires a classifier that collapses time courses into a scalar value, such as max, min, mean, or AUC Less computationally expensive than <code>sbiosobol</code>

GS A Fun cti on	Sensitivity Measure	Considerations
sbi oel eme nta rye ffe cts	<p>It computes the means and standard deviations of elementary effects of sensitivity inputs with respect to a model response.</p> <p>It assesses the average sensitivity by linear approximations of model responses, similar to averaged local sensitivities. It also assesses if the sensitivity of a model response is the same across the input parameter domain or if there is a spread of sensitivity values across the parameter domain.</p>	<ul style="list-style-type: none"> • Screens sensitivities based on linear approximations • Computes the sensitivity measures over a specified parameter domain • More computationally expensive than <code>sbiompgsa</code> and slightly less expensive than <code>sbiosobol</code>, assuming the same number of samples is used

Local Sensitivity Analysis (LSA)

In this analysis, SimBiology calculates the time-dependent sensitivities of all the species states with respect to species initial conditions and parameter values in the model.

Thus, if a model has a species x , and two parameters y and z , the time-dependent sensitivities of x with respect to each parameter value are the time-dependent derivatives

$$\frac{\partial x}{\partial y}, \frac{\partial x}{\partial z}$$

where, the numerator is the sensitivity output and the denominators are the sensitivity inputs to sensitivity analysis. For more information on the calculations performed, see [3][4][5].

Model Requirements for LSA

LSA is supported only by the ordinary differential equation (ODE) solvers. SimBiology calculates local sensitivities by combining the original ODE system for a model with the auxiliary differential equations for the sensitivities. The additional equations are derivatives of the original equations with respect to parameters. This method is sometimes called *forward sensitivity analysis* or *direct sensitivity analysis*. This larger system of ODEs is solved simultaneously by the solver.

SimBiology sensitivity analysis calculates derivatives by using a technique called complex-step approximation. This technique yields accurate results for the vast majority of typical reaction kinetics, which involve only simple mathematical operations and functions. However, this technique can produce inaccurate results when analyzing models that contain mathematical expressions that involve nonanalytic functions, such as `abs`. In this case, SimBiology either disables the sensitivity analysis or warns you that the computed sensitivities may be inaccurate. If sensitivity analysis gives questionable results for a model with reaction rates that contain unusual functions, you may be running into limitations of the complex-step technique. Contact MathWorks Technical Support for additional information.

Note Models containing the following active components do not support sensitivity analysis:

- Nonconstant compartments
 - Algebraic rules
 - Events
-

Note You can perform sensitivity analysis on a model containing repeated assignment rules, but only if the repeated assignment rules do not determine species or parameters used as inputs or outputs in sensitivity analysis.

SUNDIALS as Default Solver

SimBiology always uses the SUNDIALS solver to perform sensitivity analysis on a model, regardless of what you have selected as the SolverType in the configuration set.

In addition, if you are estimating model parameters using `sbiofit` or the Fit Data program with one of these gradient-based estimation functions: `fmincon`, `fminunc`, `lsqnonlin`, or `lsqcurvefit`, SimBiology uses the SUNDIALS solver by default to calculate sensitivities and use them to improve fitting. If you are using `sbiofit`, you can turn off this sensitivity calculation feature by setting the “SensitivityAnalysis” name-value pair argument to `false`. However, if you are using the Fit Data program, you cannot turn off this feature. It is recommended that you keep the sensitivity analysis feature on whenever possible for more accurate gradient approximations and better parameter fits.

Calculate Local Sensitivities Using `sbiosimulate`

Set the following properties of the SolverOptions property of your configset object, before running the `sbiosimulate` function:

- `SensitivityAnalysis` — Set to `true` to calculate the time-dependent sensitivities of all the species states defined by the `Outputs` property with respect to the initial conditions of the species and the values of the parameters specified in `Inputs`.
- `SensitivityAnalysisOptions` — An object that holds the sensitivity analysis options in the configuration set object. Properties of `SensitivityAnalysisOptions` are:
 - `Outputs` — Specify the species and parameters for which you want to compute the sensitivities. This is the numerator as described in “Sensitivity Analysis” on page 4-19.
 - `Inputs` — Specify the species and parameters with respect to which you want to compute the sensitivities. Sensitivities are calculated with respect to the `InitialAmount` property of the specified species. This is the denominator, described in “Sensitivity Analysis” on page 4-19.
 - `Normalization` — Specify the normalization for the calculated sensitivities:
 - `'None'` — No normalization
 - `'Half'` — Normalization relative to the numerator (species output) only
 - `'Full'` — Full dedimensionalization

For more information about normalization, see [Normalization](#).

After setting `SolverOptions` properties, calculate the sensitivities of a model by providing the `model` object as an input argument to the `sbiosimulate` function.

The `sbiosimulate` function returns a `SimData` object containing the following simulation data:

- Time points, state data, state names, and sensitivity data
- Metadata such as the types and names for the logged states, the configuration set used during simulation, and the date of the simulation

A `SimData` object is a convenient way of keeping time data, state data, sensitivity data, and associated metadata together. A `SimData` object has properties and methods associated with it, which you can use to access and manipulate the data.

For illustrated examples, see:

- “Calculate Sensitivities Using `sbiosimulate`” on page 4-24
- “Parameter Scanning, Parameter Estimation, and Sensitivity Analysis in the Yeast Heterotrimeric G Protein Cycle” on page 4-127

Calculate Local Sensitivities Using `SimFunctionSensitivity` object

Create a `SimFunctionSensitivity` object using the `createSimFunction` specifying the 'SensitivityOutputs' and 'SensitivityInputs' name-value pair arguments. Then execute the object. For an illustrated example, see “Calculate Sensitivities Using `SimFunctionSensitivity` Object”.

Calculate Local Sensitivities Using SimBiology Model Analyzer App

For a workflow example using the app, see “Find Important Parameters with Local Sensitivity Analysis Using SimBiology Model Analyzer App” on page 1-41.

References

- [1] Saltelli, Andrea, Paola Annoni, Ivano Azzini, Francesca Campolongo, Marco Ratto, and Stefano Tarantola. “Variance Based Sensitivity Analysis of Model Output. Design and Estimator for the Total Sensitivity Index.” *Computer Physics Communications* 181, no. 2 (February 2010): 259–70. <https://doi.org/10.1016/j.cpc.2009.09.018>.
- [2] Tiemann, Christian A., Joep Vanlier, Maaïke H. Oosterveer, Albert K. Groen, Peter A. J. Hilbers, and Natal A. W. van Riel. “Parameter Trajectory Analysis to Identify Treatment Effects of Pharmacological Interventions.” Edited by Scott Markel. *PLoS Computational Biology* 9, no. 8 (August 1, 2013): e1003166. <https://doi.org/10.1371/journal.pcbi.1003166>.
- [3] Martins, Joaquim, Ilan Kroo, and Juan Alonso. “An Automated Method for Sensitivity Analysis Using Complex Variables.” In *38th Aerospace Sciences Meeting and Exhibit*. Reno, NV, U.S.A.: American Institute of Aeronautics and Astronautics, 2000. <https://doi.org/10.2514/6.2000-689>.
- [4] Martins, J., Peter Sturdza, and Juan Alonso. “The Connection between the Complex-Step Derivative Approximation and Algorithmic Differentiation.” In *39th Aerospace Sciences Meeting and Exhibit*. Reno, NV, U.S.A.: American Institute of Aeronautics and Astronautics, 2001. <https://doi.org/10.2514/6.2001-921>.
- [5] Ingalls, Brian P., and Herbert M. Sauro. “Sensitivity Analysis of Stoichiometric Networks: An Extension of Metabolic Control Analysis to Non-Steady State Trajectories.” *Journal of Theoretical Biology* 222, no. 1 (May 2003): 23–36. [https://doi.org/10.1016/S0022-5193\(03\)00011-0](https://doi.org/10.1016/S0022-5193(03)00011-0).

Calculate Sensitivities Using sbiosimulate

In this section...

“Overview” on page 4-24

“Load and Configure the Model for Sensitivity Analysis” on page 4-24

“Perform Sensitivity Analysis” on page 4-25

“Extract and Plot Sensitivity Data” on page 4-25

Overview

About the Example Model

This example uses the model described in “Model of the Yeast Heterotrimeric G Protein Cycle” on page B-14 to illustrate SimBiology sensitivity analysis options.

This table lists the reactions used to model the G protein cycle and the corresponding rate parameters (rate constants) for each mass action reaction. For reversible reactions, the forward rate parameter is listed first.

No.	Name	Reaction ¹	Rate Parameters
1	Receptor-ligand interaction	$L + R \leftrightarrow RL$	kRL, kRLm
2	Heterotrimeric G protein formation	$Gd + Gbg \rightarrow G$	kG1
3	G protein activation	$RL + G \rightarrow Ga + Gbg + RL$	kGa
4	Receptor synthesis and degradation	$R \leftrightarrow \text{null}$	kRdo, kRs
5	Receptor-ligand degradation	$RL \rightarrow \text{null}$	kRD1
6	G protein inactivation	$Ga \rightarrow Gd$	kGd

¹ Legend of species: L = ligand (alpha factor), R = alpha-factor receptor, Gd = inactive G-alpha-GDP, Gbg = free levels of G-beta:G-gamma complex, G = inactive Gbg:Gd complex, Ga = active G-alpha-GTP

About the Example

Assume that you are calculating the sensitivity of species Ga with respect to every parameter in the model. Thus, you want to calculate the time-dependent derivatives

$$\frac{\partial(Ga)}{\partial(kRLm)}, \frac{\partial(Ga)}{\partial(kRL)}, \frac{\partial(Ga)}{\partial(kG1)}, \frac{\partial(Ga)}{\partial(kGa)} \dots$$

Load and Configure the Model for Sensitivity Analysis

- 1 The `gprotein_norules.sbproj` project contains a model that represents the wild-type strain (stored in variable `m1`).

```
sbioloadproject gprotein_norules m1
```

- The options for sensitivity analysis are in the configuration set object. Get the configuration set object from the model.

```
csObj = getconfigset(m1);
```

- Use the `sbioselect` function, which lets you query by type, to retrieve the Ga species from the model.

```
Ga = sbioselect(m1, 'Type', 'species', 'Where', 'Name', '==', 'Ga');
```

- Set the `Outputs` property of the `SensitivityAnalysisOptions` object to the Ga species.

```
csObj.SensitivityAnalysisOptions.Outputs = Ga;
```

- Use the `sbioselect` function, which lets you query by type, to retrieve all the parameters from the model and store the vector in a variable, `pif`.

```
pif = sbioselect(m1, 'Type', 'parameter');
```

- Set the `Inputs` property of the `SensitivityAnalysisOptions` object to the `pif` variable containing the parameters.

```
csObj.SensitivityAnalysisOptions.Inputs = pif;
```

- Enable sensitivity analysis in the configuration set object (`csObj`) by setting the `SensitivityAnalysis` option to `true`.

```
csObj.SolverOptions.SensitivityAnalysis = true;
```

- Set the `Normalization` property of the `SensitivityAnalysisOptions` object to perform 'Full' normalization.

```
csObj.SensitivityAnalysisOptions.Normalization = 'Full';
```

Perform Sensitivity Analysis

Simulate the model and return the data to a `SimData` object:

```
simDataObj = sbiosimulate(m1);
```

Extract and Plot Sensitivity Data

You can extract sensitivity results using the `getsensmatrix` method of a `SimData` object. In this example, `R` is the sensitivity of the species `Ga` with respect to eight parameters. This example shows how to compare the variation of sensitivity of `Ga` with respect to various parameters, and find the parameters that affect `Ga` the most.

- Extract sensitivity data in output variables `T` (time), `R` (sensitivity data for species `Ga`), `snames` (names of the states specified for sensitivity analysis), and `ifacs` (names of the input factors used for sensitivity analysis):

```
[T, R, snames, ifacs] = getsensmatrix(simDataObj);
```

- Because `R` is a 3-D array with dimensions corresponding to times, output factors, and input factors, reshape `R` into columns of input factors to facilitate visualization and plotting:

```
R2 = squeeze(R);
```

- After extracting the data and reshaping the matrix, plot the data:

```
figure;
plot(T,R2);
title('Normalized Sensitivity of Ga With Respect To Various Parameters');
```

```

xlabel('Time (seconds)');
ylabel('Normalized Sensitivity of Ga');
leg = legend(ifact, 'Location', 'NorthEastOutside');
set(leg, 'Interpreter', 'none');

```

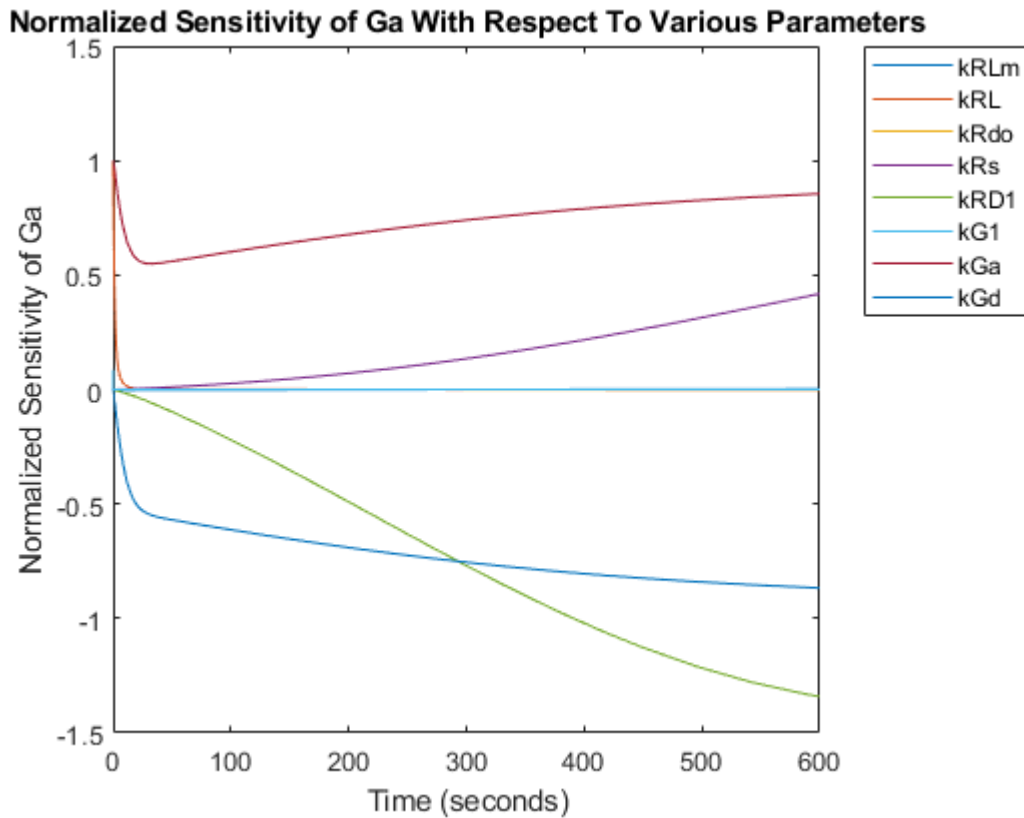

From the previous plot you can see that Ga is most sensitive to parameters kGd, kRs, kRD1, and kGa. This suggests that the amounts of active G protein in the cell depends on the rate of:

- Receptor synthesis
- Degradation of the receptor-ligand complex
- G protein activation
- G protein inactivation

Perform a Parameter Scan

This example shows how to perform a parameter scan by simulating a model multiple times, each time varying the value of a parameter.

In the model described in Model of the Yeast Heterotrimeric G Protein Cycle, the rate of G protein inactivation (k_{Gd}) is much lower in the mutant strain versus the wild-type strain ($k_{Gd} = 0.004$ versus $k_{Gd} = 0.11$), which explains higher levels of activated G protein (G_a) in the mutant strain. For a detailed look at how varying the level of k_{Gd} affects the level of G_a , perform a parameter scan over different values of k_{Gd} .

Load the `gprotein.sbproj` project, which includes the variable `m1`, a model object.

```
sbioloadproject gprotein
```

Create a vector of five evenly spaced values for k_{Gd} ranging from 0.001 to 0.15 .

```
kGdValues = linspace(1e-3,0.15,5)';
```

Create a `SimFunction` object, where k_{Gd} is the input parameter to scan, and G_a is the observed species. Pass in an empty array `[]` as the last input argument to denote there are no dosed species.

```
simfunc = createSimFunction(m1,{'kGd'},{'Ga'},[]);
```

Simulate the model multiple times with different k_{Gd} values. Set the stop time to 1000.

```
sd = simfunc(kGdValues,1000);
```

Plot the simulation results to see how varying the level of k_{Gd} affects the level of G_a .

```
sbioplot(sd);
```

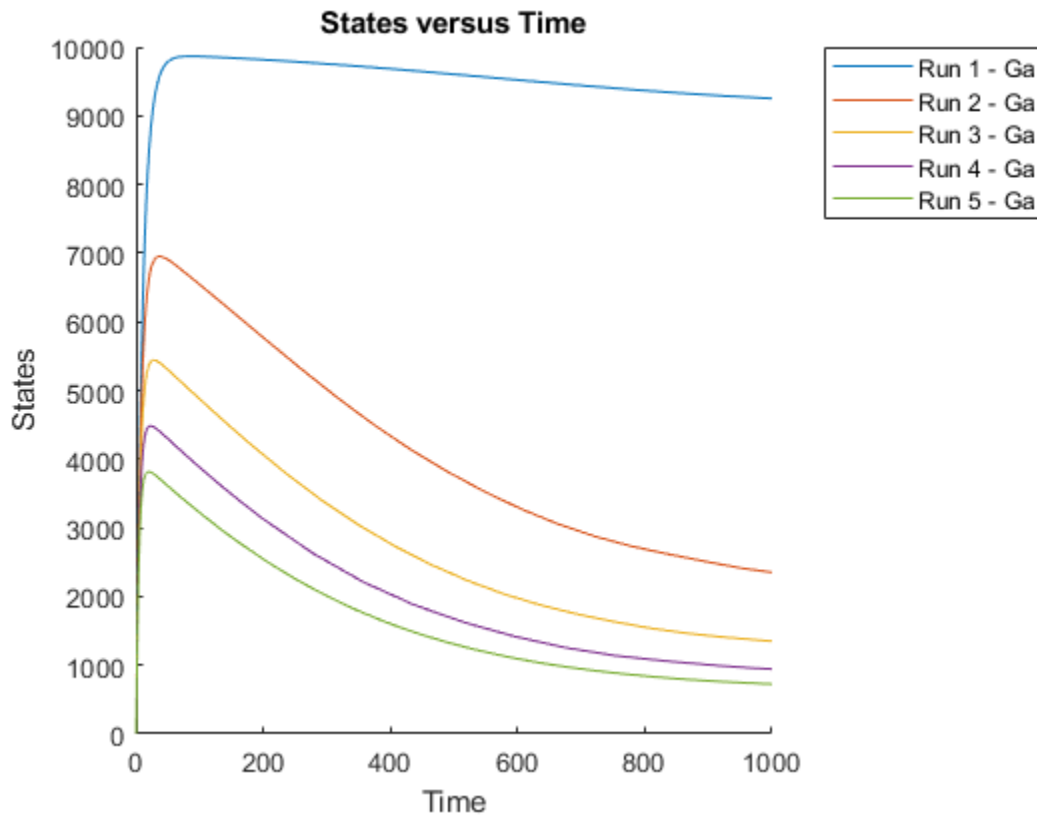

See Also

`createSimFunction` | `SimFunction` object

More About

- “Model of the Yeast Heterotrimeric G Protein Cycle” on page B-14

Nonlinear Mixed-Effects Modeling

In this section...

“What Is a Nonlinear Mixed-Effects Model?” on page 4-29

“Nonlinear Mixed-Effects Modeling Workflow” on page 4-30

“Specify a Covariate Model” on page 4-31

“Specify an Error Model” on page 4-33

“Maximum Likelihood Estimation” on page 4-33

“Obtain the Fitting Status” on page 4-33

What Is a Nonlinear Mixed-Effects Model?

A mixed-effects model is a statistical model that incorporates both *fixed effects* and *random effects*. Fixed effects are population parameters assumed to be the same each time data is collected, and random effects are random variables associated with each sample (individual) from a population. Mixed-effects models work with small sample sizes and sparse data sets, and are often used to make inferences on features underlying profiles of repeated measurements from a group of individuals from a population of interest.

As with all regression models, their purpose is to describe a response variable as a function of the predictor (independent) variables. Mixed-effects models, however, recognize correlations within sample subgroups, providing a reasonable compromise between ignoring data groups entirely, thereby losing valuable information, and fitting each group separately, which requires significantly more data points.

For instance, consider population pharmacokinetic data that involve the administration of a drug to several individuals and the subsequent observation of drug concentration for each individual, and the objective is to make a broader inference on population-wide parameters while considering individual variations. The nonlinear function often used for such data is an exponential function since many drugs once distributed in a patient are eliminated in an exponential fashion. Thus the measured drug concentration of an individual can be described as:

$$y_{ij} = \frac{D_i}{V} e^{-k_i t_{ij}} + a \varepsilon_{ij},$$

where y_{ij} is the j th response of the i th individual, D_i is the dose administered to the i th individual, V is the population mean volume of distribution, a is an error parameter, and $\varepsilon_{ij} \sim N(0, 1)$, representing some measurement error. The elimination rate parameter (k_i) depends on the clearance and volume of the central compartment $k_i = \frac{Cl_i}{V}$. Both k_i and Cl_i are for the i th patient, meaning they are patient-specific parameters.

To account for variations between individuals, assume that the clearance is a random variable depending on individuals, varying around the population mean. For the i th individual, $Cl_i = \theta_1 + \eta_i$, where θ_1 is the fixed effect (population parameter for the clearance) and η_i is the random effect, that is, the deviation of the i th individual from the mean clearance of the population $\eta_i \sim N(0, \sigma_\eta^2)$.

If you have any individual-specific covariates such as weight w that linearly relate to the clearance, you can try explaining some of the between-individual differences. For example, if w_i is the weight of

the i th individual, then the model becomes $Cl_i = \theta_1 + \theta_2 * w_i + \eta_i$, where θ_2 is the fixed effect of weight on clearance.

A general nonlinear mixed-effects (NLME) model with constant variance is as follows:

$$y_{ij} = f(x_{ij}, p_i) + \varepsilon_{ij}$$

$$p_i = A_i\theta + B_i\eta_i$$

$$\varepsilon_{ij} \sim N(0, \sigma^2)$$

$$\eta_i \sim N(0, \Psi)$$

y_{ij}	Data vector of individual-specific response values
f	General, real-valued function of p_i and x_{ij}
x_{ij}	Data matrix of individual-specific predictor values
p_i	Vector of individual-specific model parameters
θ	Vector of fixed effects, modeling population parameters
η_i	Vector of multivariate normally distributed individual-specific random effects
A_i	Individual-specific design matrix for combining fixed effects
B_i	Individual-specific design matrix for combining random effects
ε_{ij}	Vector of group-specific errors, assumed to be independent, identically, normally distributed, and independent of η_i
Ψ	Covariance matrix for the random effects
σ^2	Error variance, assumed to be constant across observations

In addition to the constant error model, there are other error models such as proportional, exponential, and combined error models. For details, see “Error Models” on page 4-44.

Nonlinear Mixed-Effects Modeling Workflow

SimBiology lets you estimate fixed effects θ s and random effects η s as well as the covariance matrix of random effects Ψ . However, you cannot alter A and B design matrices since they are automatically determined from the covariate model you specify. Use the `sbiofitmixed` function to estimate nonlinear mixed-effects parameters. These steps show one of the workflows you can use at the command line.

- 1 Import data.
- 2 Convert the data to the `groupedData` format.
- 3 Define dosing data. For details, see “Doses in SimBiology Models” on page 2-30.
- 4 Create a structural model (one-, two-, or multicompartment model). For details, see “Create Pharmacokinetic Models” on page 5-14.
- 5 Create a covariate model to define parameter-covariate relationships if any. For details, see “Specify a Covariate Model” on page 4-31.
- 6 Map the response variable from data to the model component. For example, if you have the measured drug concentration data for the central compartment, then map it to the drug species in the central compartment (typically the `Drug_Central` species).

- 7 Specify parameters to estimate using the `EstimatedInfo` object. It lets you optionally specify parameter transformations, initial values, and parameter bounds. Supported transforms are `log`, `probit`, `logit`, and `none` (no transform).
- 8 (Optional) You can also specify an error model. The default model is the constant error model. For instance, you can change it to the proportional error model if you assume the measurement error is proportional to the response data. See “Specify an Error Model” on page 4-33.
- 9 Estimate parameters using `fitproblem` or `sbiointmixed`, which performs “Maximum Likelihood Estimation” on page 4-33.
- 10 (Optional) If you have a large, complex model, the estimation might take longer. SimBiology lets you check the status of fitting as it progresses. See “Obtain the Fitting Status” on page 4-33.

For workflow examples, see:

- “Modeling the Population Pharmacokinetics of Phenobarbital in Neonates” on page 4-153
- “Fit PK Parameters Using SimBiology Problem-Based Workflow” on page 4-193

Specify a Covariate Model

When specifying a nonlinear mixed-effects model, you define parameter-covariate relationship using a covariate model (`CovariateModel` object). For example, suppose you have PK profile data for multiple individuals and are estimating three parameters (clearance Cl , compartment volume V , and elimination rate k) that have both fixed and random effects. Assume the clearance Cl has a correlation with a covariate variable weight (w) of each individual. Each parameter can be described as a linear combination of fixed and random effects.

$$Cl_i = \theta_1 + \theta_2 * w_i + \eta_{1i},$$

$$V_i = \theta_3 + \eta_{2i},$$

$$k_i = \theta_4 + \eta_{3i},$$

where θ s represent fixed effects and η s represent random effects, which are normally distributed

$$\begin{pmatrix} \eta_{1i} \\ \eta_{2i} \\ \eta_{3i} \end{pmatrix} \sim MVN(0, \Psi). \text{ By default, the random effects are uncorrelated. So } \Psi = \begin{pmatrix} \sigma_1^2 & 0 & 0 \\ 0 & \sigma_2^2 & 0 \\ 0 & 0 & \sigma_3^2 \end{pmatrix}.$$

- 1 Construct an empty `CovariateModel` object.

```
covModel = CovariateModel;
```

- 2 Set the `Expression` property to define the relationships between parameters (Cl , V , and k) and covariate (w). You must use `theta` as a prefix for all fixed effects and `eta` for random effects.

```
covModel.Expression = {'Cl = theta1 + theta2*w + eta1', 'V = theta3 + eta2', 'k = theta4 + eta3'}
```

The `FixedEffectNames` property displays the fixed effects defined in the model.

```
covModel.FixedEffectNames
```

```
ans =
```

```
'theta1'
'theta3'
'theta4'
'theta2'
```

The `FixedEffectDescription` property displays which fixed effects correspond to which parameter. For instance, *theta1* is the fixed effect for the *Cl* parameter, and *theta2* is the fixed effect for the weight covariate that has a correlation with *Cl* parameter, denoted as *Cl/w*.

```
covModel.FixedEffectDescription
```

```
ans =
```

```
'Cl'
'V'
'k'
'Cl/w'
```

- 3 Specify initial estimates for the fixed effects. Create a structure containing initial estimates using the `constructDefaultFixedEffectValues` function.

```
initialEstimates = constructDefaultFixedEffectValues(covModel)
```

```
initialEstimates =
```

```
theta1: 0
theta2: 0
theta3: 0
theta4: 0
```

```
initialEstimates.theta1 = 1.20;
initialEstimates.theta2 = 0.30;
initialEstimates.theta3 = 0.90;
initialEstimates.theta4 = 0.10;
```

- 4 Set the initial estimates to the `FixedEffectValues` property.

```
covModel.FixedEffectValues = initialEstimates;
```

Specify a Covariance Pattern Among Random Effects

By default, `sbiofitmixed` assumes no covariance among random effects, that is, a diagonal covariance matrix is used. Suppose you have η_1 , η_2 , and η_3 , and there is a covariance σ_{12} between η_1 and η_2 . You can indicate this using a pattern matrix where 1 indicates a variance or covariance

parameter which is estimated by `sbiofitmixed`. For instance, a pattern matrix $\begin{pmatrix} 1 & 1 & 0 \\ 1 & 1 & 0 \\ 0 & 0 & 1 \end{pmatrix}$ represents

$$\begin{pmatrix} \sigma_1^2 & \sigma_{12} & 0 \\ \sigma_{21} & \sigma_2^2 & 0 \\ 0 & 0 & \sigma_3^2 \end{pmatrix}.$$

Define such a pattern using an options struct.

```
options.CovPattern = [1 1 0;1 1 0;0 0 1];
```

Then you can use `options` as an input argument for `sbiofitmixed`. For a complete workflow, see “Nonlinear Mixed-Effects Modeling Workflow” on page 4-30.

Specify an Error Model

During the “Nonlinear Mixed-Effects Modeling Workflow” on page 4-30, you can optionally specify an error model using a structure.

```
options.ErrorModel = 'proportional';
```

Then you can use `options` as one of the input arguments when you run `sbiofitmixed`.

Supported error models are constant (default), proportional, combined, and exponential models. For details, see “Error Models” on page 4-44.

Maximum Likelihood Estimation

SimBiology estimates the parameters of a nonlinear mixed-effects model by maximizing a likelihood function. The function can be described as:

$$p(y|\theta, \sigma^2, \Psi) = \int p(y|\theta, \eta, \sigma^2)p(\eta|\Psi) d\eta,$$

where y is the response data, θ is the vector of fixed effects, σ^2 is the error variance, Ψ is the covariance matrix for random effects, and η is the vector of unobserved random effects. $p(y|\theta, \sigma^2, \Psi)$ is the marginal density of y , $p(y|\theta, \eta, \sigma^2)$ is the conditional density of y given the random effects η , and the prior distribution of η is $p(\eta|\Psi)$.

This integral contains a nonlinear function of the fixed effects and variance parameters that you want to maximize. Typically for nonlinear models, the integral does not have a closed form, and needs to be solved numerically, which involves simulating the function at each time step of an optimization algorithm. Therefore, the estimation can take a long time for complex models, and initial values of parameters might play an important role for successful convergence. SimBiology provides these iterative algorithms to solve the integral and maximize the likelihood if you have Statistics and Machine Learning Toolbox.

- LME — Use the likelihood for the linear mixed-effects model at the current conditional estimates of θ and η . This is the default.
- RELME — Use the restricted likelihood for the linear mixed-effects model at the current conditional estimates of θ and η .
- FO — First-order (Laplacian) approximation without random effects.
- FOCE — First-order (Laplacian) approximation at the conditional estimates of θ .
- stochastic EM — Use the Expectation-Maximization (EM) algorithm in which the E step is replaced by a stochastic procedure.

For a complete workflow, see “Nonlinear Mixed-Effects Modeling Workflow” on page 4-30.

Obtain the Fitting Status

During the estimation of mixed-effects parameters of a large and complex model that may take a longer time, you may want to obtain the status of fitting as it progresses. Set `'ProgressPlot'` to `true` when you run `sbiofitmixed` to display the progress of the fitting. For details, see “Progress Plot” on page 4-45.

For a complete workflow, see “Nonlinear Mixed-Effects Modeling Workflow” on page 4-30.

See Also

`sbiofitmixed` | `sbiofit`

More About

- “Progress Plot” on page 4-45
- “Nonlinear Regression” on page 4-35
- “Supported Methods for Parameter Estimation in SimBiology” on page 4-42

Nonlinear Regression

In this section...

“What is Nonlinear Regression?” on page 4-35

“Fitting Options in SimBiology” on page 4-35

“Parameter Transformations” on page 4-37

“Maximum Likelihood Estimation” on page 4-38

“Fitting Workflow for sbiofit” on page 4-40

What is Nonlinear Regression?

The purpose of regression models is to describe a response variable as a function of independent variables. Multiple linear regression models describe the response as a linear combination of coefficients and functions of independent variables. Nonlinearities can be modeled using nonlinear functions of independent variables. However, the coefficients always enter the model in a linear fashion.

Nonlinear regression models are more mechanistic models of nonlinear relationships between the response and independent variables. The parameters can enter the model as exponential, trigonometric, power, or any other nonlinear function. The unknown parameters in the model are estimated by minimizing a statistical criterion such as the negative log likelihood or the sum of squared deviations between observed and predicted values.

In the case of pharmacokinetic (PK) studies, the response data usually represent some measured drug concentrations, and independent variables are often dose and time. The nonlinear function often used for such data is an exponential function since many drugs once distributed in a patient are eliminated in an exponential fashion. One PK parameter to estimate in this case is the rate at which the drug is eliminated from the body given the concentration-time data.

For instance, consider drug plasma concentration data from a single individual after an intravenous bolus dose measured at different time points with some errors. Assume the measured drug concentration follows a monoexponential decline: $C_t = C_0 e^{-k_e t} + a\varepsilon$.

This model describes the time course of drug concentration in the body (C_t), as a function of the drug concentration after an intravenous bolus dose at $t = 0$ (C_0), time (t), and elimination rate parameter (k_e). ε is the mean-zero and unit-variance variable, that is, $\varepsilon \sim N(0, 1)$ representing the measurement error and a is the error model parameter (here, standard deviation).

More generically, you can write the model as

$$y_i = f(t; p) + g(\varepsilon_i)$$

where y_i is the i th response (such as drug concentration), f is a function of time t and model parameters p (such as k_e), and an error model $g(\varepsilon_i)$.

Fitting Options in SimBiology

This table summarizes nonlinear regression options available in SimBiology.

Fitting Option	Example
<p>Individual-specific parameter estimation (Unpooled fitting)</p> <p>Fit each individual separately, resulting in one set of parameter estimates for each individual.</p>	
<p>Category- or group-specific parameter estimation</p> <p>Fit each category or group separately, resulting in one set of parameter estimates for each category.</p>	
<p>Population-wide parameter estimation (Pooled fitting)</p> <p>Fit all of the data pooled together, resulting in just one set of parameter estimates.</p>	

In addition, SimBiology supports four kinds of error models for measured or observed responses, namely, constant (default), proportional, combined, and exponential. For details, see “Error Models” on page 4-44. Depending on the optimization method, you can specify an error model for each response or all responses. For details, see “Supported Methods for Parameter Estimation in SimBiology” on page 4-42.

Parameter Transformations

SimBiology supports three parameter transformations. These parameter transformations can be useful to improve fitting convergence or to enforce parameter bounds.

The general model explained previously on page 4-35 is $y_i = f(t; p) + g(\varepsilon_i)$, where p is model parameters that you can transform. Consider the following two equations.

$$\beta = T(p)$$

$$p = T^{-1}(\beta)$$

Here, β represents *transformed* model parameters, p represents *untransformed* model parameters, T is the transformation, and T^{-1} is the inverse transformation.

SimBiology performs parameter estimation using the transformed parameters β , which means that the transformed model $F(t; \beta) = f(t; T^{-1}(\beta))$ is used, where F is the model function using the transformed parameters. Equivalently, the model function can be rewritten as $f(t; p) = F(t; T(p))$.

In other words, the SimBiology optimizer uses the *transformed* values during maximum likelihood estimation but the reported fit result is reverted back to the model space (*untransformed* values). For example, if you are estimating a clearance parameter Cl that is log-transformed, you have $Cl_\beta = \log(Cl)$, where Cl_β is what the optimizer uses and Cl is what the model sees.

Specifying parameter transformations imposes implicit bounds on the untransformed parameter values. The `log` transformation keeps the parameter value to be always positive, and the `logit` and `probit` transformations keep the parameter value to be between 0 and 1. Alternatively, you can specify further constraints on the parameter values by providing explicit bounds for untransformed parameters p or for the transformed parameters β .

Transformation	Transformed Parameter and Range†	Untransformed Parameter and Range†	Description
log	$\beta = \log(p)$ $\in [-Inf, Inf]$	$p = \exp(\beta)$ $\in [0, Inf]$	In many cases, the <code>log</code> transformation is useful for parameters, such as rate constants, whose values might span several orders of magnitude and exploring the parameter space for such parameters. The <code>log</code> transformation can be also useful for positive physical quantities, such as clearance or compartment volume. Applying the <code>log</code> transformation imposes an implicit bound on the untransformed parameter so that its value is always positive.

Transformation	Transformed Parameter and Range†	Untransformed Parameter and Range‡	Description
logit	β $= \text{logit}(p) =$ $\left(\frac{p}{1-p}\right) \in [-Inf, Inf]$	$p = 1 /$ $(1 + \exp$ $(-\beta)) \in [0,$ $1]$	The logit transformation imposes an implicit bound (between 0 and 1) on the untransformed parameter value. It can be useful for parameters that have values only between 0 and 1, such as bioavailability. Alternatively, you can specify the parameter bounds (using an <code>EstimatedInfo</code> object) instead of specifying the logit transformation.
probit	β $= \text{norminv}$ $(p) \in [-Inf, Inf]$	$p = \text{normcdf}$ $(\beta) \in [0, 1]$	Similar to logit, the probit transformation imposes an implicit bound (between 0 and 1) on the untransformed parameter value. SimBiology uses the normal inverse cumulative distribution function <code>norminv</code> . The probit transformation requires Statistics and Machine Learning Toolbox.

† Use the `InitialTransformedValue` and `TransformedBounds` properties of an `EstimatedInfo` object to set the initial transformed value and transformed bounds to the desired subset of the range.

‡ Use the `InitialValue` and `Bounds` properties of an `EstimatedInfo` object to set the initial untransformed value and untransformed bounds to the desired subset of the range.

Maximum Likelihood Estimation

SimBiology estimates parameters by the method of maximum likelihood. Rather than directly maximizing the likelihood function, SimBiology constructs an equivalent minimization problem. Whenever possible, the estimation is formulated as a weighted least squares (**WLS**) optimization that minimizes the sum of the squares of weighted residuals. Otherwise, the estimation is formulated as the minimization of the negative of the logarithm of the likelihood (**NLL**). The **WLS** formulation often converges better than the **NLL** formulation, and SimBiology can take advantage of specialized **WLS** algorithms, such as the Levenberg-Marquardt algorithm implemented in `lsqnonlin` and `lsqcurvefit`. SimBiology uses **WLS** when there is a single error model that is constant, proportional, or exponential. SimBiology uses **NLL** if you have a combined error model or a multiple-error model, that is, a model having an error model for each response.

`sbiofit` supports different optimization methods, and passes in the formulated **WLS** or **NLL** expression to the optimization method that minimizes it. For simplicity, each expression shown below assumes only one error model and one response. If there are multiple responses, SimBiology takes the sum of the expressions that correspond to error models of given responses.

	Expression that is being minimized
Weighted Least Squares (WLS)	For the constant error model, $\sum_i^N (y_i - f_i)^2$
	For the proportional error model, $\sum_i^N \frac{(y_i - f_i)^2}{f_i^2 / f_{gm}^2}$
	For the exponential error model, $\sum_i^N (\ln y_i - \ln f_i)^2$
	For numeric weights, $\sum_i^N \frac{(y_i - f_i)^2}{w_{gm} / w_i}$
Negative Log-likelihood (NLL)	For the combined error model and multiple-error model, $\sum_i^N \frac{(y_i - f_i)^2}{2\sigma_i^2} + \sum_i^N \ln \sqrt{2\pi\sigma_i^2}$

The variables are defined as follows.

N	Number of experimental observations
y_i	The i th experimental observation
f_i	Predicted value of the i th observation
σ_i	Standard deviation of the i th observation. <ul style="list-style-type: none"> • For the constant error model, $\sigma_i = a$ • For the proportional error model, $\sigma_i = b f_i$ • For the combined error model, $\sigma_i = a + b f_i$
f_{gm}	$f_{gm} = \left(\prod_i^N f_i \right)^{1/N}$
w_i	The weight of the i th predicted value
w_{gm}	$w_{gm} = \left(\prod_i^N w_i \right)^{1/N}$

When you use numeric weights or the weight function, the weights are assumed to be inversely proportional to the variance of the error, that is, $\sigma_i^2 = \frac{a^2}{w_i}$ where a is the constant error parameter. If you use weights, you cannot specify an error model except the constant error model.

Various optimization methods have different requirements on the function that is being minimized. For some methods, the estimation of model parameters is performed independently of the estimation of the error model parameters. The following table summarizes the error models and any separate formulas used for the estimation of error model parameters, where a and b are error model parameters and e is the standard mean-zero and unit-variance (Gaussian) variable.

Error Model	Error Parameter Estimation Function
'constant': $y_i = f_i + ae$	$a^2 = \frac{1}{N} \sum_i^N (y_i - f_i)^2$
'exponential': $y_i = f_i \exp(ae)$	$a^2 = \frac{1}{N} \sum_i^N (\ln y_i - \ln f_i)^2$
'proportional': $y_i = f_i + b f_i e$	$b^2 = \frac{1}{N} \sum_i^N \left(\frac{y_i - f_i}{f_i} \right)^2$
'combined': $y_i = f_i + (a + b f_i)e$	Error parameters are included in the minimization.
Weights	$a^2 = \frac{1}{N} \sum_i^N (y_i - f_i)^2 w_i$

Note `nlinfit` only support single error models, not multiple-error models, that is, response-specific error models. For a combined error model, it uses an iterative **WLS** algorithm. For other error models, it uses the **WLS** algorithm as described previously. For details, see `nlinfit`.

Fitting Workflow for `sbiofit`

The following steps show one of the workflows you can use at the command line to fit a PK model.

- 1 Import data.
- 2 Convert the data to the `groupedData` format.
- 3 Define dosing data. For details, see “Doses in SimBiology Models” on page 2-30.
- 4 Create a structural model (one-, two-, or a multicompartment model). For details, see “Create Pharmacokinetic Models” on page 5-14.
- 5 Map the response variable from data to the model component. For example, if you have the measured drug concentration data for the central compartment, then map it to the drug species in the central compartment (typically the `Drug_Central` species).
- 6 Specify parameters to estimate using an `EstimatedInfo` object. Optionally, you can specify parameter transformations, initial values, and parameter bounds.
- 7 Perform parameter estimation using `sbiofit` or `fitproblem`.

For illustrated examples, see the following.

- “Fit PK Parameters Using SimBiology Problem-Based Workflow” on page 4-193
- “Fit One-Compartment Model to Individual PK Profile”

- “Fit Two-Compartment Model to PK Profiles of Multiple Individuals”
- “Estimate Category-Specific PK Parameters for Multiple Individuals”

See Also

`sbiofit` | `groupedData` | `EstimatedInfo` object | `sbiofitmixed`

More About

- “Multiple Parameter Estimations in Parallel”
- “Parameter Estimation with Hybrid Solvers”
- “Progress Plot” on page 4-45
- “Supported Methods for Parameter Estimation in SimBiology” on page 4-42

Supported Methods for Parameter Estimation in SimBiology

SimBiology supports a variety of optimization methods for least-squares and mixed-effects estimation problems. Depending on the optimization method, you can specify parameter bounds for estimated parameters as well as response-specific error models, that is, an error model for each response variable. The following table summarizes the supported optimization methods in SimBiology, fitting options, and the corresponding toolboxes that are required in addition to MATLAB and SimBiology.

Method	Additional Toolbox Required	Supports Parameter Bounds	Uses Parameter Sensitivities [†]	Response-specific Error Models	Fixed or Mixed Effects	Supports Stochastic EM Algorithm	SimBiology Function to Use
fminsearch	—	Yes*	No	Yes	Fixed	No	sbiofit or fitproblem
scattersearch	—	Yes	Depends on the selected local solver.	Depends on the selected local solver.	Fixed	No	
nlinfit	Statistics and Machine Learning Toolbox	Yes*	No	No	Fixed	No	
fminunc	Optimization Toolbox	Yes*	Yes	Yes	Fixed	No	
fmincon	Optimization Toolbox	Yes	Yes	Yes	Fixed	No	
lsqcurvefit	Optimization Toolbox	Yes	Yes	Yes	Fixed	No	
lsqnonlin	Optimization Toolbox	Yes	Yes	Yes	Fixed	No	
patternsearch	Global Optimization Toolbox	Yes	No	Yes	Fixed	No	
ga	Global Optimization Toolbox	Yes	No	Yes	Fixed	No	
particleswarm	Global Optimization Toolbox	Yes	No	Yes	Fixed	No	
nlmefit	Statistics and Machine Learning Toolbox	No	No	No	Mixed	No	sbiofitmixed or fitproblem

Method	Additional Toolbox Required	Supports Parameter Bounds	Uses Parameter Sensitivities [†]	Response-specific Error Models	Fixed or Mixed Effects	Supports Stochastic EM Algorithm	SimBiology Function to Use
nlmefitsa	Statistics and Machine Learning Toolbox	No	No	No	Mixed	Yes	

[†] This column indicates whether the algorithm allows using parameter sensitivities to determine gradients of the objective function.

* When using `fminsearch`, `nlmefitsa`, or `fminunc` with bounds, the objective function returns `Inf` if bounds are exceeded. When you turn on options such as `FunValCheck`, the optimization may error if bounds are exceeded during estimation. If using `nlmefitsa`, it may report warnings about the Jacobian being ill-conditioned or not being able to estimate if the final result is too close to the bounds.

See Also

`sbiofit` | `sbiofitmixed`

More About

- “Nonlinear Regression”
- “Nonlinear Mixed-Effects Modeling”

Error Models

SimBiology supports the error models described in the following table. For instance, if you assume every observation has a constant amount of noise, use the constant error model, which is the default. Instead, if you assume the error is proportional to the response data, then the proportional error model might be more appropriate.

Error Model	Mathematical Representation	Standard Deviation of Error Model
constant (default)	$y = f + a\varepsilon$	a
proportional	$y = f + b f \varepsilon$	$b f $
combined	$y = f + (a + b f)\varepsilon$	$a + b f $
exponential	$y = f * \exp(a\varepsilon)$ or equivalently,	$\sqrt{e^{a^2} - 1} * e^a$
	$\log(y) = \log(f) + a\varepsilon$	a

Here, y is the response, f is the function value, ε is a standard mean-zero and unit-variance (Gaussian) variable, and a and b are error parameters. For instance, if you assume the error is approximately 5% of each observation, use the proportional error model with $b = 0.05$. In SimBiology, f typically represents the simulation result.

See Also

More About

- “Nonlinear Regression”
- “Nonlinear Mixed-Effects Modeling”

Progress Plot

The progress plot provides the live feedback on the status of parameter estimation while using `sbiofit`, `sbiofitmixed`, or the **Fit Data** program in the **SimBiology Model Analyzer** app. When you enable this feature, a new figure opens and shows the fitting quality measures such as log-likelihood and estimated parameter values for each function iteration. The plot monitors the progress whether you are running the fit on a local machine or in parallel using remote clusters.

When you estimate parameters, you can specify which estimation method on page 4-42 to use during the fitting. The progress plot is shown for all the estimation methods except for `nlinfit`. However, the progress plot differs depending on whether you are using a nonlinear mixed-effects method (`nlmefit` or `nlmefitsa`) or a nonlinear regression method, such as `lsqnonlin`.

Progress Plot for Nonlinear Mixed-Effects Methods

The progress plot figure contains a series of subplots. Specifically, the subplots show the values of fixed-effect parameters (θ), the estimates of the variance parameters, that is, the diagonal elements of the covariance matrix of the random effects (Ψ), and the log-likelihood.

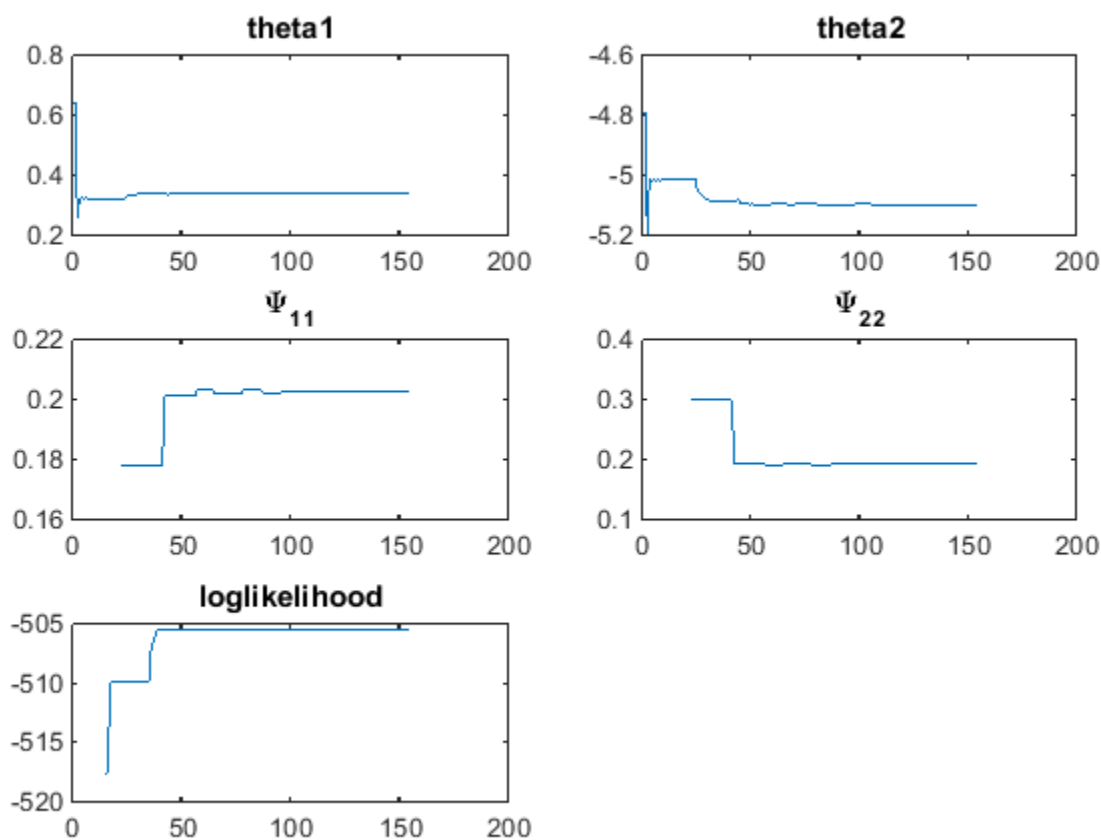

Here are some tips for interpreting the plots.

- The fitting function tries to maximize the log-likelihood. When the plot begins to display a flat line, this might indicate that maximization is complete. Try setting the maximum iterations to a lower number to reduce the number of iterations you need and improve performance.
- Plots for the fixed effects (θ s) and the variance parameters (Ψ s) should show convergence. If you see oscillations, or jumps without accompanying improvements in the log-likelihood, the model may be overparameterized. Try the following:
 - Reduce the number of fixed effects.
 - Reduce the number of random effects.
 - Simplify the covariance matrix pattern of random effects (if you have previously changed it from the default diagonal matrix).

Progress Plot for Nonlinear Regression Methods

The progress plot figure shows a series of subplots, and there are two categories of plots: quality measure plots on page 4-46 and estimated parameter plots on page 4-49. For a pooled fit, that is, estimating one set of parameter values for all groups (or individuals), there is only one line for each plot and the line is faded when the fit is finished. For an unpooled fit, that is, estimating one set of parameter values for each group (or individual), each line represents a single individual or group. You can select one or more lines by clicking and dragging the mouse cursor to create a rectangle on any plot. All lines that intersect the rectangle are selected and highlighted across all plots.

You can terminate the fitting at any time by selecting **Stop**, and partial results are returned. Specifically, for a pooled fit, the result up to the last function iteration is returned. For an unpooled fit, results for any groups that have finished running are returned. The groups currently running are interrupted and partial results from the last iteration are also returned.

Quality Measure Plots

The quality measure plots include the log-likelihood, first-order optimality, and termination condition plots. They occupy the first row of the figure.

Log-likelihood

The estimation method tries to maximize the log-likelihood, and the plot shows the log-likelihood value for each function iteration. When the plot begins to display a flat line, it often indicates that maximization is complete. Try setting the maximum iterations to a lower number to reduce the number of iterations you need and improve performance.

For a pooled fit, there is only one line in the plot and the line is faded when the fit finishes. The log-likelihood plot shows whether the fit converges or fails along with the information on the estimation method termination condition. The next figure is an example of the log-likelihood plot of a pooled fit.

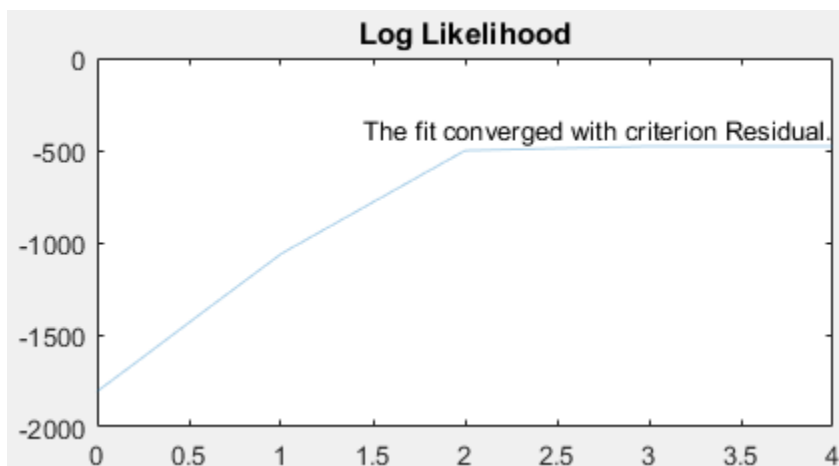

First-order Optimality

First-order optimality is a measure of how close a point x is to optimal, and the plot is shown when you are using the Optimization Toolbox methods (`lsqnonlin`, `lsqcurvefit`, `fminunc`, and `fmincon`). The first-order optimality measure must be zero at a minimum, but a point with first-order optimality equal to zero is not necessarily a minimum. For details, see [First-order optimality \(Optimization Toolbox\)](#).

Termination Condition

For a pooled fit, the termination condition is displayed together with the log-likelihood plot. For details about the termination condition, refer to the `exitflag` output argument description of the corresponding estimation method. Suppose that you are using the `lsqnonlin` method and see a message: `The fit converged with criterion Residual`. By checking the `exitflag` conditions of the `lsqnonlin` with the keyword `Residual`, this termination condition corresponds to the `exitflag` value of 3, that is, change in the residual was less than the specified tolerance.

For an unpooled fit, the **Termination Conditions** plot contains the summary (histogram) of termination criteria for all groups (or individuals) as shown in the next figure. The y-axis represents the total number of fits for each termination condition, and the x-axis displays all the termination criteria.

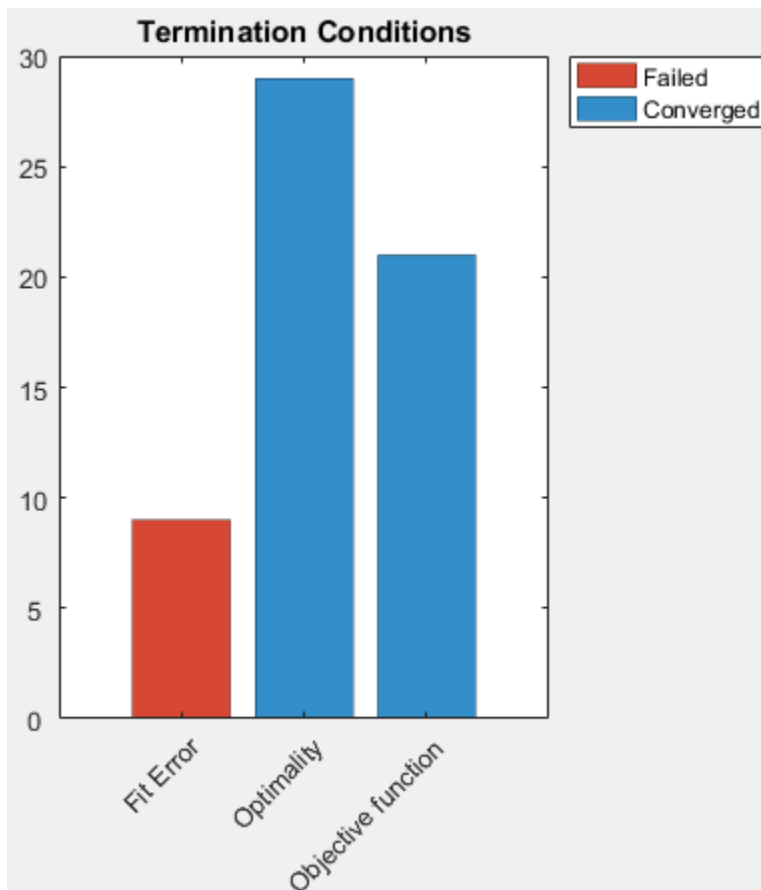

Hybrid Functions

If you are performing a hybrid optimization by first running a global solver, such as `ga` or `particleswarm`, followed by a hybrid function, the `ProgressPlot` also shows the quality measure plots for the hybrid function in the second row. The following figure is an example where the global optimization algorithm is `ga` and the hybrid function is `fminunc`. For an illustrated example, see "Parameter Estimation with Hybrid Solvers".

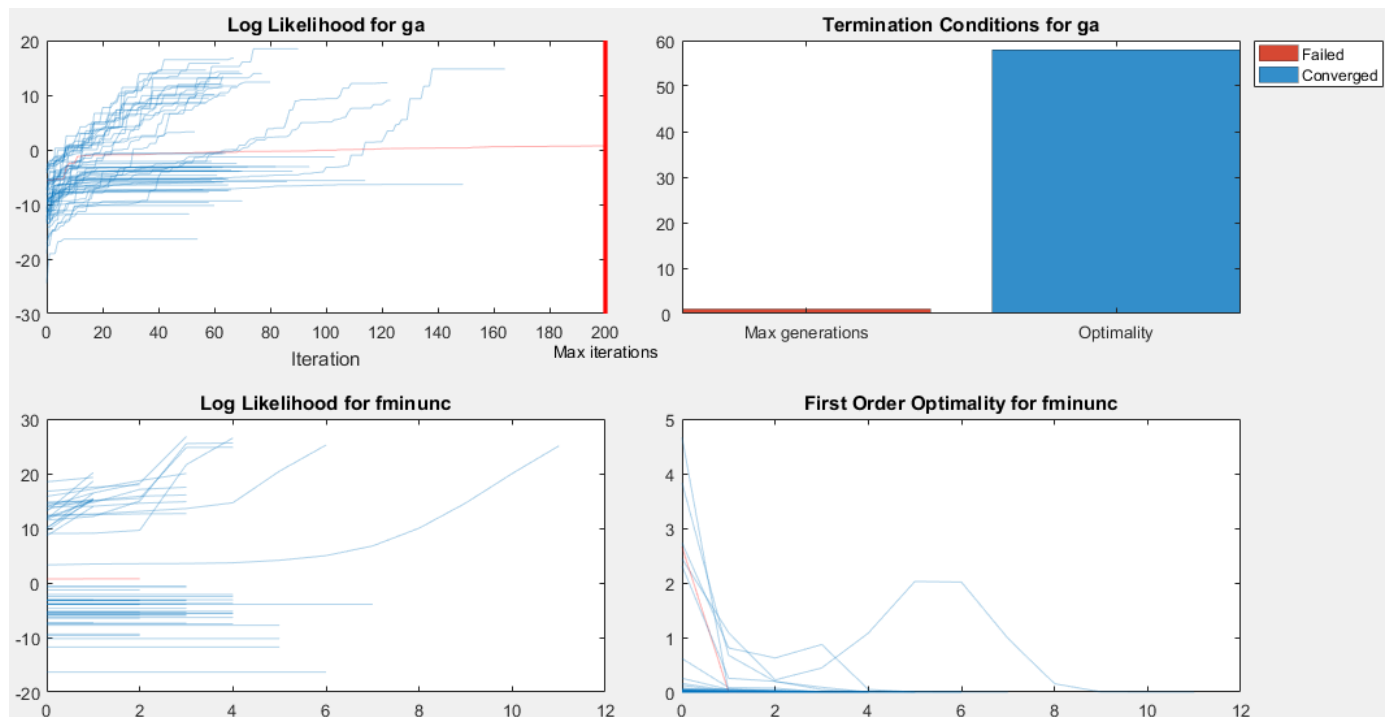

Estimated Parameter Plot

This plot displays the value of the estimated parameter versus iteration for each group. One estimated parameter plot is displayed for each parameter. The plots start on the second row of the figure and can span multiple rows. Each plot displays a horizontal dashed line for any lower or upper bound you specify for the estimated parameter. The bound lines show only if the range of the plot can include the lines.

For an unpooled fit, the Progress Plot also displays a histogram that shows the distribution of the parameter values for the completed runs. Use the toggle button over the y-axis for each plot to switch between the log and linear scale. The next figure shows an example of an estimated parameter plot with the bound information and distribution of estimated values.

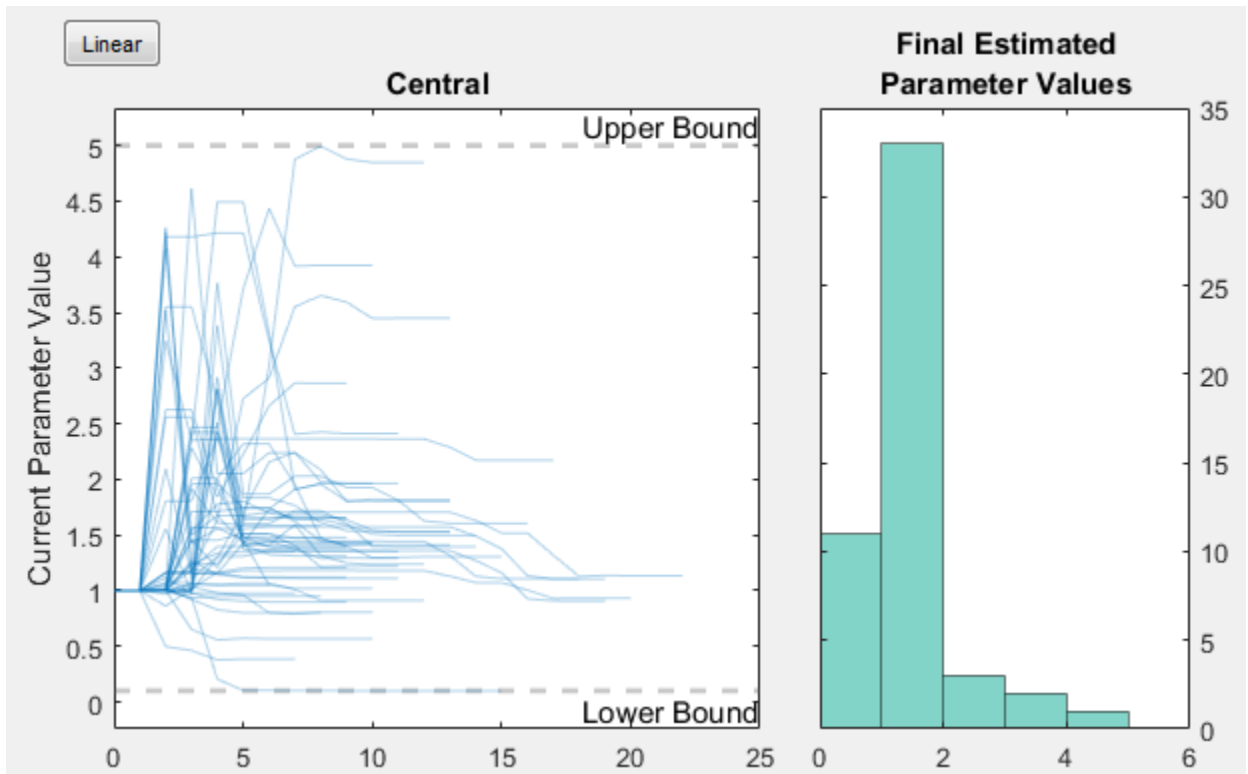

If you have a hierarchical model and are estimating parameters for each category such as estimating parameters for males versus females, the Progress Plot displays one plot per estimated parameter for each category. For example, in the next figure, the *Central* and *Peripheral* parameters are estimated for the age categories while *Q12* and *CI_Central* are estimated for the sex categories.

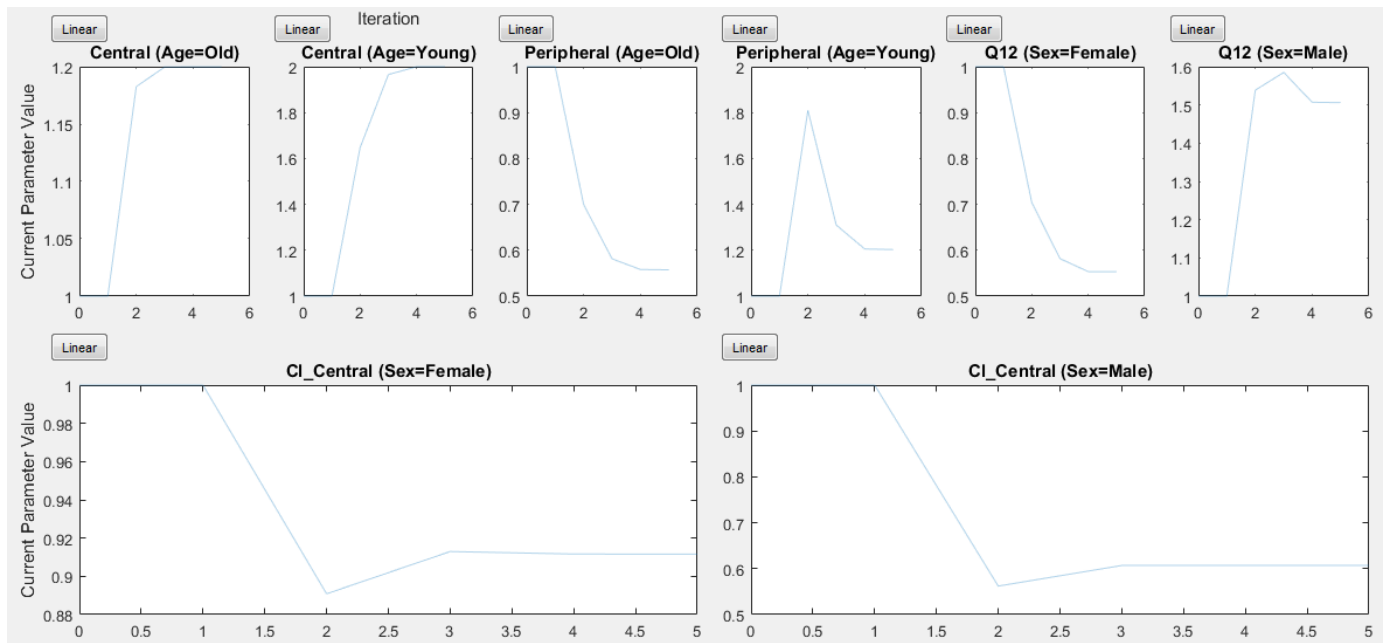

Status Bar

For an unpooled fit running in parallel, the Progress Plot displays a status bar in the bottom right corner. The bar shows information about the remaining and completed number of individuals (or groups) throughout the fit.

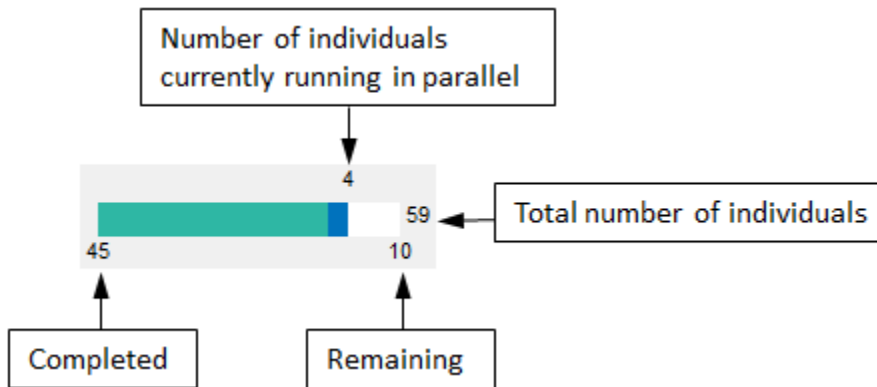

See Also

`sbiofit` | `sbiofitmixed` | `sbiofitstatusplot`

More About

- “Nonlinear Regression” on page 4-35
- “Nonlinear Mixed-Effects Modeling” on page 4-29
- “Supported Methods for Parameter Estimation in SimBiology” on page 4-42
- “Troubleshooting Simulation Problems” on page 3-15
- “Accelerating Model Simulations and Analyses” on page 4-85

Fit One-Compartment Model to Individual PK Profile

Background

This example shows how to fit an individual's PK profile data to one-compartment model and estimate pharmacokinetic parameters.

Suppose you have drug plasma concentration data from an individual and want to estimate the volume of the central compartment and the clearance. Assume the drug concentration versus the time profile follows the monoexponential decline $C_t = C_0 e^{-k_e t}$, where C_t is the drug concentration at time t , C_0 is the initial concentration, and k_e is the elimination rate constant that depends on the clearance and volume of the central compartment $k_e = Cl/V$.

The synthetic data in this example was generated using the following model, parameters, and dose:

- One-compartment model with bolus dosing and first-order elimination
- Volume of the central compartment (Central) = 1.70 liter
- Clearance parameter (Cl_Central) = 0.55 liter/hour
- Constant error model
- Bolus dose of 10 mg

Load Data and Visualize

The data is stored as a table with variables `Time` and `Conc` that represent the time course of the plasma concentration of an individual after an intravenous bolus administration measured at 13 different time points. The variable units for `Time` and `Conc` are hour and milligram/liter, respectively.

```
load('data15.mat')
plot(data.Time,data.Conc,'b+')
xlabel('Time (hour)');
ylabel('Drug Concentration (milligram/liter)');
```

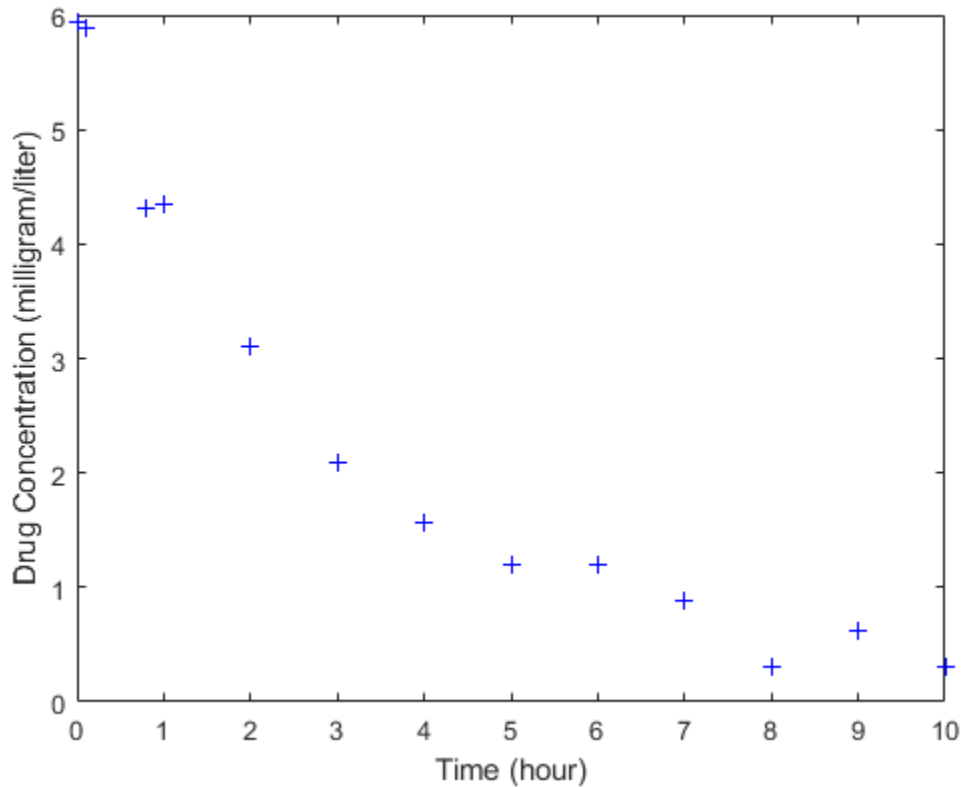
Convert to groupedData Format

Convert the data set to a `groupedData` object, which is the required data format for the fitting function `sbiofit` for later use. A `groupedData` object also lets you set independent variable and group variable names (if they exist). Set the units of the `Time` and `Conc` variables. The units are optional and only required for the `UnitConversion` feature, which automatically converts matching physical quantities to one consistent unit system.

```
gData = groupedData(data);
gData.Properties.VariableUnits = {'hour', 'milligram/liter'};
gData.Properties

ans = struct with fields:
    Description: ''
    UserData: []
    DimensionNames: {'Row' 'Variables'}
    VariableNames: {'Time' 'Conc'}
    VariableDescriptions: {}
    VariableUnits: {'hour' 'milligram/liter'}
    VariableContinuity: []
    RowNames: {}
    CustomProperties: [1x1 matlab.tabular.CustomProperties]
    GroupVariableName: ''
    IndependentVariableName: 'Time'
```

groupedData automatically set the name of the IndependentVariableName property to the Time variable of the data.

Construct a One-Compartment Model

Use the built-in PK library to construct a one-compartment model with bolus dosing and first-order elimination where the elimination rate depends on the clearance and volume of the central compartment. Use the configset object to turn on unit conversion.

```
pkmd          = PKModelDesign;
pkc1          = addCompartment(pkmd, 'Central');
pkc1.DosingType    = 'Bolus';
pkc1.EliminationType = 'linear-clearance';
pkc1.HasResponseVariable = true;
model         = construct(pkmd);
configset     = getConfigset(model);
configset.CompileOptions.UnitConversion = true;
```

For details on creating compartmental PK models using the SimBiology® built-in library, see “Create Pharmacokinetic Models” on page 5-14.

Define Dosing

Define a single bolus dose of 10 milligram given at time = 0. For details on setting up different dosing schedules, see “Doses in SimBiology Models” on page 2-30.

```
dose          = sbiodose('dose');
dose.TargetName = 'Drug_Central';
dose.StartTime = 0;
dose.Amount    = 10;
dose.AmountUnits = 'milligram';
dose.TimeUnits = 'hour';
```

Map Response Data to the Corresponding Model Component

The data contains drug concentration data stored in the Conc variable. This data corresponds to the Drug_Central species in the model. Therefore, map the data to Drug_Central as follows.

```
responseMap = {'Drug_Central = Conc'};
```

Specify Parameters to Estimate

The parameters to fit in this model are the volume of the central compartment (Central) and the clearance rate (Cl_Central). In this case, specify log-transformation for these biological parameters since they are constrained to be positive. The estimatedInfo object lets you specify parameter transforms, initial values, and parameter bounds if needed.

```
paramsToEstimate = {'log(Central)', 'log(Cl_Central)'};
estimatedParams  = estimatedInfo(paramsToEstimate, 'InitialValue', [1 1], 'Bounds', [1 5; 0.5 2]);
```

Estimate Parameters

Now that you have defined one-compartment model, data to fit, mapped response data, parameters to estimate, and dosing, use sbiofit to estimate parameters. The default estimation function that sbiofit uses will change depending on which toolboxes are available. To see which function was used during fitting, check the EstimationFunction property of the corresponding results object.

```
fitConst = sbiofit(model, gData, responseMap, estimatedParams, dose);
```

Display Estimated Parameters and Plot Results

Notice the parameter estimates were not far off from the true values (1.70 and 0.55) that were used to generate the data. You may also try different error models to see if they could further improve the parameter estimates.

```
fitConst.ParameterEstimates
```

```
ans=2x4 table
```

Name	Estimate	StandardError	Bounds	
{'Central' }	1.6993	0.034821	1	5
{'Cl_Central' }	0.53358	0.01968	0.5	2

```
s.Labels.XLabel = 'Time (hour)';
s.Labels.YLabel = 'Concentration (milligram/liter)';
plot(fitConst,'AxesStyle',s);
```

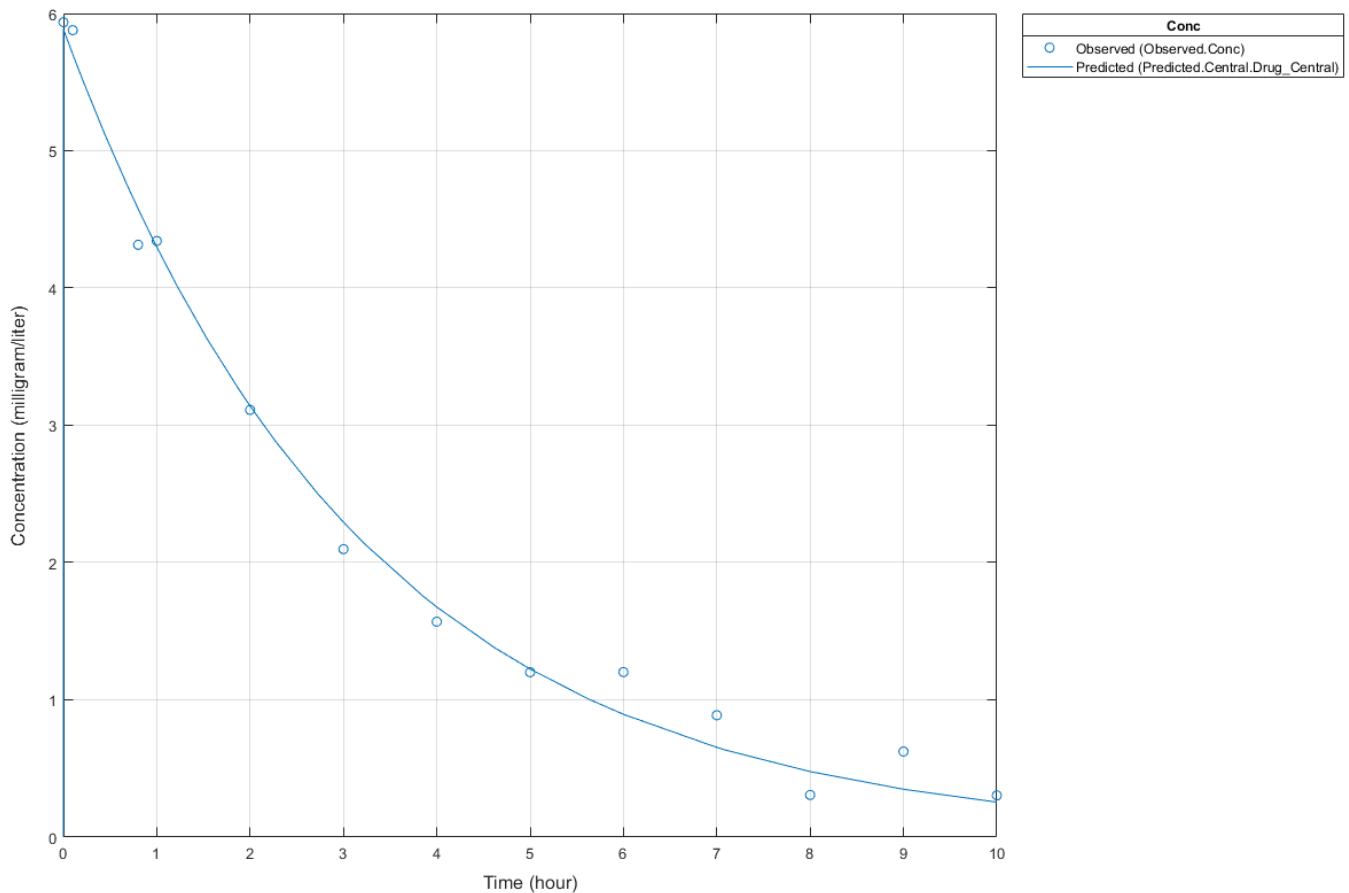

Use Different Error Models

Try three other supported error models (proportional, combination of constant and proportional error models, and exponential).

```

fitProp = sbiofit(model,gData,responseMap,estimatedParams,dose,...
                'ErrorModel','proportional');
fitExp  = sbiofit(model,gData,responseMap,estimatedParams,dose,...
                'ErrorModel','exponential');
fitComb = sbiofit(model,gData,responseMap,estimatedParams,dose,...
                'ErrorModel','combined');

```

Use Weights Instead of an Error Model

You can specify weights as a numeric matrix, where the number of columns corresponds to the number of responses. Setting all weights to 1 is equivalent to the constant error model.

```

weightsNumeric = ones(size(gData.Conc));
fitWeightsNumeric = sbiofit(model,gData,responseMap,estimatedParams,dose,'Weights',weightsNumeric);

```

Alternatively, you can use a function handle that accepts a vector of predicted response values and returns a vector of weights. In this example, use a function handle that is equivalent to the proportional error model.

```

weightsFunction = @(y) 1./y.^2;
fitWeightsFunction = sbiofit(model,gData,responseMap,estimatedParams,dose,'Weights',weightsFunction);

```

Compare Information Criteria for Model Selection

Compare the loglikelihood, AIC, and BIC values of each model to see which error model best fits the data. A larger likelihood value indicates the corresponding model fits the model better. For AIC and BIC, the smaller values are better.

```

allResults = [fitConst,fitWeightsNumeric,fitWeightsFunction,fitProp,fitExp,fitComb];
errorModelNames = {'constant error model','equal weights','proportional weights', ...
                  'proportional error model','exponential error model',...
                  'combined error model'};
LogLikelihood = [allResults.LogLikelihood]';
AIC = [allResults.AIC]';
BIC = [allResults.BIC]';
t = table(LogLikelihood,AIC,BIC);
t.Properties.RowNames = errorModelNames;
t

```

t=6x3 table

	LogLikelihood	AIC	BIC
constant error model	3.9866	-3.9732	-2.8433
equal weights	3.9866	-3.9732	-2.8433
proportional weights	-3.8472	11.694	12.824
proportional error model	-3.8257	11.651	12.781
exponential error model	1.1984	1.6032	2.7331
combined error model	3.9163	-3.8326	-2.7027

Based on the information criteria, the constant error model (or equal weights) fits the data best since it has the largest loglikelihood value and the smallest AIC and BIC.

Display Estimated Parameter Values

Show the estimated parameter values of each model.

```

Estimated_Central      = zeros(6,1);
Estimated_Cl_Central  = zeros(6,1);
t2 = table(Estimated_Central,Estimated_Cl_Central);
t2.Properties.RowNames = errorModelNames;
for i = 1:height(t2)
    t2{i,1} = allResults(i).ParameterEstimates.Estimate(1);
    t2{i,2} = allResults(i).ParameterEstimates.Estimate(2);
end
t2

```

t2=6x2 table

	Estimated_Central	Estimated_Cl_Central
constant error model	1.6993	0.53358
equal weights	1.6993	0.53358
proportional weights	1.9045	0.51734
proportional error model	1.8777	0.51147
exponential error model	1.7872	0.51701
combined error model	1.7008	0.53271

Conclusion

This example showed how to estimate PK parameters, namely the volume of the central compartment and clearance parameter of an individual, by fitting the PK profile data to one-compartment model. You compared the information criteria of each model and estimated parameter values of different error models to see which model best explained the data. Final fitted results suggested both the constant and combined error models provided the closest estimates to the parameter values used to generate the data. However, the constant error model is a better model as indicated by the loglikelihood, AIC, and BIC information criteria.

See Also

sbiofit

More About

- “Fit a Two-Compartment Model to PK Profiles of Multiple Individuals” on page 4-71
- “Estimate Category-Specific PK Parameters for Multiple Individuals” on page 4-58
- “Nonlinear Regression” on page 4-35

Estimate Category-Specific PK Parameters for Multiple Individuals

This example shows how to estimate category-specific (such as young versus old, male versus female), individual-specific, and population-wide parameters using PK profile data from multiple individuals.

Background

Suppose you have drug plasma concentration data from 30 individuals and want to estimate pharmacokinetic parameters, namely the volumes of central and peripheral compartment, the clearance, and intercompartmental clearance. Assume the drug concentration versus the time profile follows the biexponential decline $C_t = Ae^{-at} + Be^{-bt}$, where C_t is the drug concentration at time t , and a and b are slopes for corresponding exponential declines.

Load Data

This synthetic data contains the time course of plasma concentrations of 30 individuals after a bolus dose (100 mg) measured at different times for both central and peripheral compartments. It also contains categorical variables, namely Sex and Age.

```
clear
load('sd5_302RAgeSex.mat')
```

Convert to groupedData Format

Convert the data set to a `groupedData` object, which is the required data format for the fitting function `sbiofit`. A `groupedData` object also allows you set independent variable and group variable names (if they exist). Set the units of the ID, Time, CentralConc, PeripheralConc, Age, and Sex variables. The units are optional and only required for the `UnitConversion` feature, which automatically converts matching physical quantities to one consistent unit system.

```
gData = groupedData(data);
gData.Properties.VariableUnits = {'','hour','milligram/liter','milligram/liter','',''};
gData.Properties
```

```
ans = struct with fields:
    Description: ''
    UserData: []
    DimensionNames: {'Row' 'Variables'}
    VariableNames: {1x6 cell}
    VariableDescriptions: {}
    VariableUnits: {1x6 cell}
    VariableContinuity: []
    RowNames: {}
    CustomProperties: [1x1 matlab.tabular.CustomProperties]
    GroupVariableName: 'ID'
    IndependentVariableName: 'Time'
```

The `IndependentVariableName` and `GroupVariableName` properties have been automatically set to the Time and ID variables of the data.

Visualize Data

Display the response data for each individual.

```
t = sbiotrellis(gData,'ID','Time',{ 'CentralConc', 'PeripheralConc'},...
               'Marker','+', 'LineStyle','none');
% Resize the figure.
t.hFig.Position(:) = [100 100 1280 800];
```

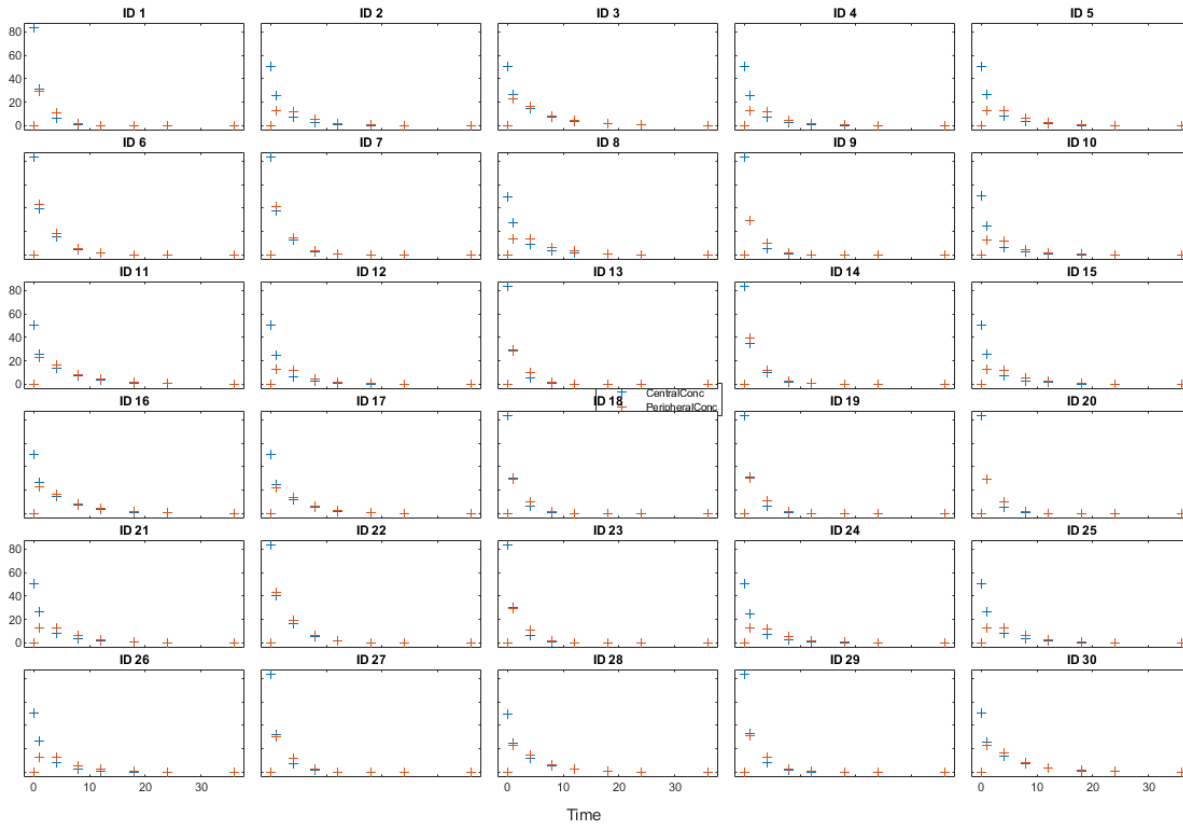

Set Up a Two-Compartment Model

Use the built-in PK library to construct a two-compartment model with infusion dosing and first-order elimination where the elimination rate depends on the clearance and volume of the central compartment. Use the `configset` object to turn on unit conversion.

```
pkmd = PKModelDesign;
pkc1 = addCompartment(pkmd, 'Central');
pkc1.DosingType = 'Bolus';
pkc1.EliminationType = 'linear-clearance';
pkc1.HasResponseVariable = true;
pkc2 = addCompartment(pkmd, 'Peripheral');
model = construct(pkmd);
configset = getconfigset(model);
configset.CompileOptions.UnitConversion = true;
```

For details on creating compartmental PK models using the SimBiology® built-in library, see “Create Pharmacokinetic Models” on page 5-14.

Define Dosing

Assume every individual receives a bolus dose of 100 mg at time = 0. For details on setting up different dosing strategies, see “Doses in SimBiology Models” on page 2-30.

```
dose = sbiodose('dose', 'TargetName', 'Drug_Central');
dose.StartTime = 0;
dose.Amount = 100;
dose.AmountUnits = 'milligram';
dose.TimeUnits = 'hour';
```

Map the Response Data to Corresponding Model Components

The data contains measured plasma concentration in the central and peripheral compartments. Map these variables to the appropriate model components, which are `Drug_Central` and `Drug_Peripheral`.

```
responseMap = {'Drug_Central = CentralConc', 'Drug_Peripheral = PeripheralConc'};
```

Specify Parameters to Estimate

Specify the volumes of central and peripheral compartments `Central` and `Peripheral`, intercompartmental clearance `Q12`, and clearance `Cl_Central` as parameters to estimate. The `estimatedInfo` object lets you optionally specify parameter transforms, initial values, and parameter bounds. Since both `Central` and `Peripheral` are constrained to be positive, specify a log-transform for each parameter.

```
paramsToEstimate = {'log(Central)', 'log(Peripheral)', 'Q12', 'Cl_Central'};
estimatedParam = estimatedInfo(paramsToEstimate, 'InitialValue', [1 1 1 1]);
```

Estimate Individual-Specific Parameters

Estimate one set of parameters for each individual by setting the 'Pooled' name-value pair argument to `false`.

```
unpooledFit = sbiofit(model, gData, responseMap, estimatedParam, dose, 'Pooled', false);
```

Display Results

Plot the fitted results versus the original data for each individual (group).

```
plot(unpooledFit);
```

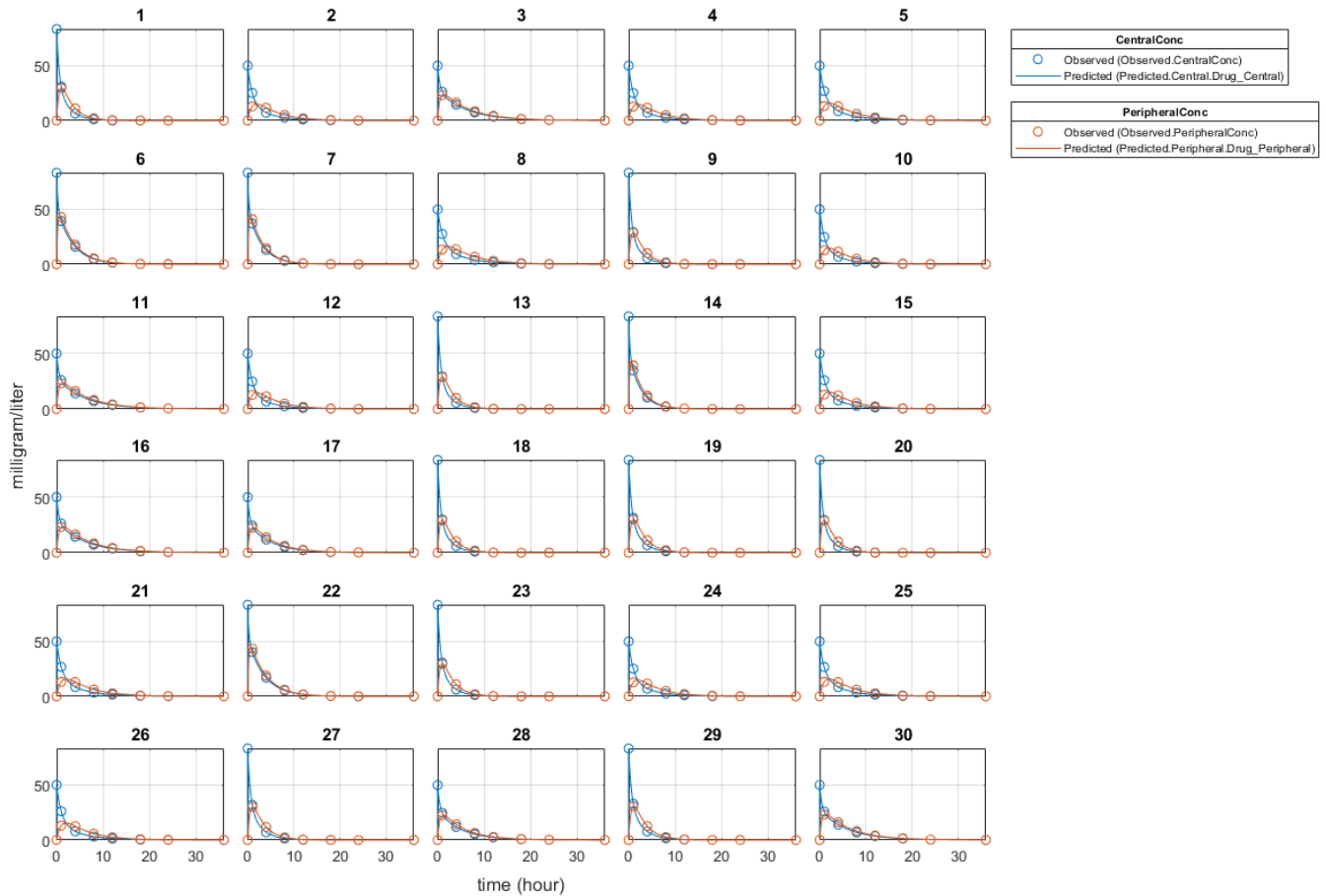
For an unpooled fit, `sbiofit` always returns one results object for each individual.

Examine Parameter Estimates for Category Dependencies

Explore the unpooled estimates to see if there is any category-specific parameters, that is, if some parameters are related to one or more categories. If there are any category dependencies, it might be possible to reduce the number of degrees of freedom by estimating just category-specific values for those parameters.

First extract the ID and category values for each ID

```
catParamValues = unique(gData(:, {'ID', 'Sex', 'Age'}));
```

Add variables to the table containing each parameter's estimate.

```
allParamValues = vertcat(unpooledFit.ParameterEstimates);
catParamValues.Central = allParamValues.Estimate(strcmp(allParamValues.Name, 'Central'));
catParamValues.Peripheral = allParamValues.Estimate(strcmp(allParamValues.Name, 'Peripheral'));
catParamValues.Q12 = allParamValues.Estimate(strcmp(allParamValues.Name, 'Q12'));
catParamValues.Cl_Central = allParamValues.Estimate(strcmp(allParamValues.Name, 'Cl_Central'));
```

Plot estimates of each parameter for each category. `gscatter` requires Statistics and Machine Learning Toolbox™. If you do not have it, use other alternative plotting functions such as `plot`.

```
h = figure;
ylabls = {'Central', 'Peripheral', 'Cl_Central', 'Q12'};
```

```

plotNumber = 1;
for i = 1:4
    thisParam = estimatedParam(i).Name;

    % Plot for Sex category
    subplot(4,2,plotNumber);
    plotNumber = plotNumber + 1;
    gscatter(double(catParamValues.Sex), catParamValues.(thisParam), catParamValues.Sex);
    ax = gca;
    ax.XTick = [];
    ylabel(ylabels(i));
    legend('Location','bestoutside')
    % Plot for Age category
    subplot(4,2,plotNumber);
    plotNumber = plotNumber + 1;
    gscatter(double(catParamValues.Age), catParamValues.(thisParam), catParamValues.Age);
    ax = gca;
    ax.XTick = [];
    ylabel(ylabels(i));
    legend('Location','bestoutside')
end
% Resize the figure.
h.Position(:) = [100 100 1280 800];

```

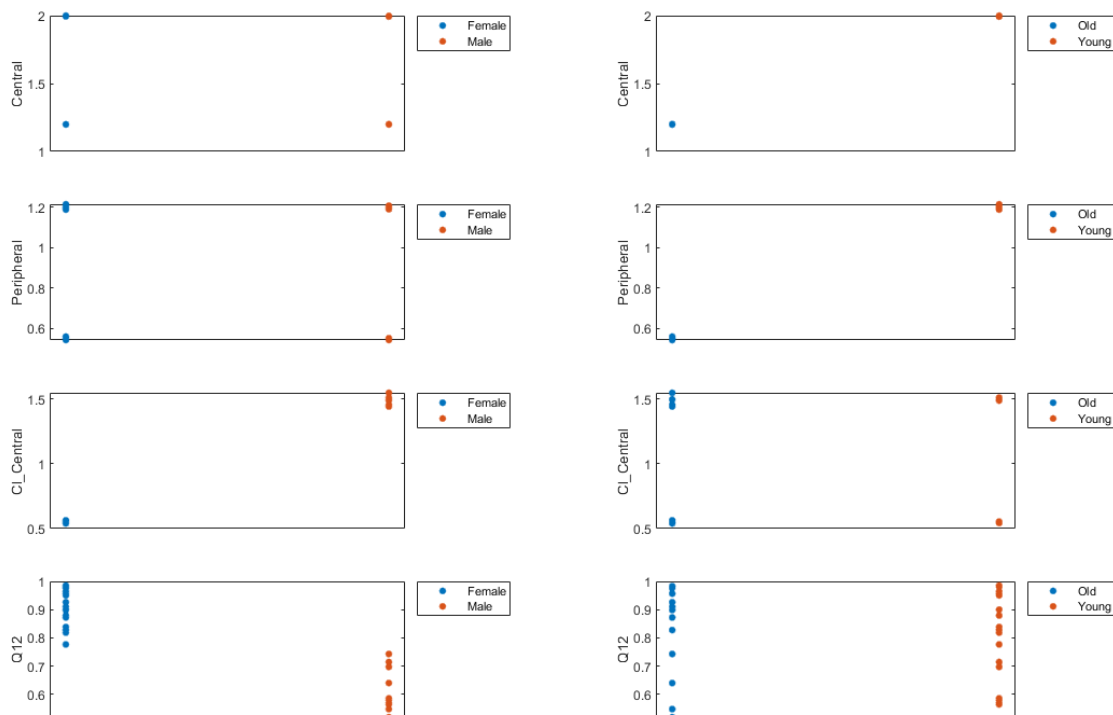

Based on the plot, it seems that young individuals tend to have higher volumes of central and peripheral compartments (Central, Peripheral) than old individuals (that is, the volumes seem to

be age-specific). In addition, males tend to have higher clearance rates (`Cl_Central`) than females but the opposite for the Q12 parameter (that is, the clearance and Q12 seem to be sex-specific).

Estimate Category-Specific Parameters

Use the `'CategoryVariableName'` property of the `estimatedInfo` object to specify which category to use during fitting. Use `'Sex'` as the group to fit for the clearance `Cl_Central` and Q12 parameters. Use `'Age'` as the group to fit for the `Central` and `Peripheral` parameters.

```
estimatedParam(1).CategoryVariableName = 'Age';
estimatedParam(2).CategoryVariableName = 'Age';
estimatedParam(3).CategoryVariableName = 'Sex';
estimatedParam(4).CategoryVariableName = 'Sex';
categoryFit = sbiofit(model,gData,responseMap,estimatedParam,dose)
```

```
categoryFit =
  OptimResults with properties:
      ExitFlag: 3
      Output: [1x1 struct]
      GroupName: []
      Beta: [8x5 table]
      ParameterEstimates: [120x6 table]
      J: [240x8x2 double]
      COVB: [8x8 double]
      CovarianceMatrix: [8x8 double]
      R: [240x2 double]
      MSE: 0.4362
      SSE: 205.8690
      Weights: []
      LogLikelihood: -477.9195
      AIC: 971.8390
      BIC: 1.0052e+03
      DFE: 472
      DependentFiles: {1x3 cell}
      EstimatedParameterNames: {'Central' 'Peripheral' 'Q12' 'Cl_Central'}
      ErrorModelInfo: [1x3 table]
      EstimationFunction: 'lsqnonlin'
```

When fitting by category (or group), `sbiofit` always returns one results object, not one for each category level. This is because both male and female individuals are considered to be part of the same optimization using the same error model and error parameters, similarly for the young and old individuals.

Plot Results

Plot the category-specific estimated results.

```
plot(categoryFit);
```

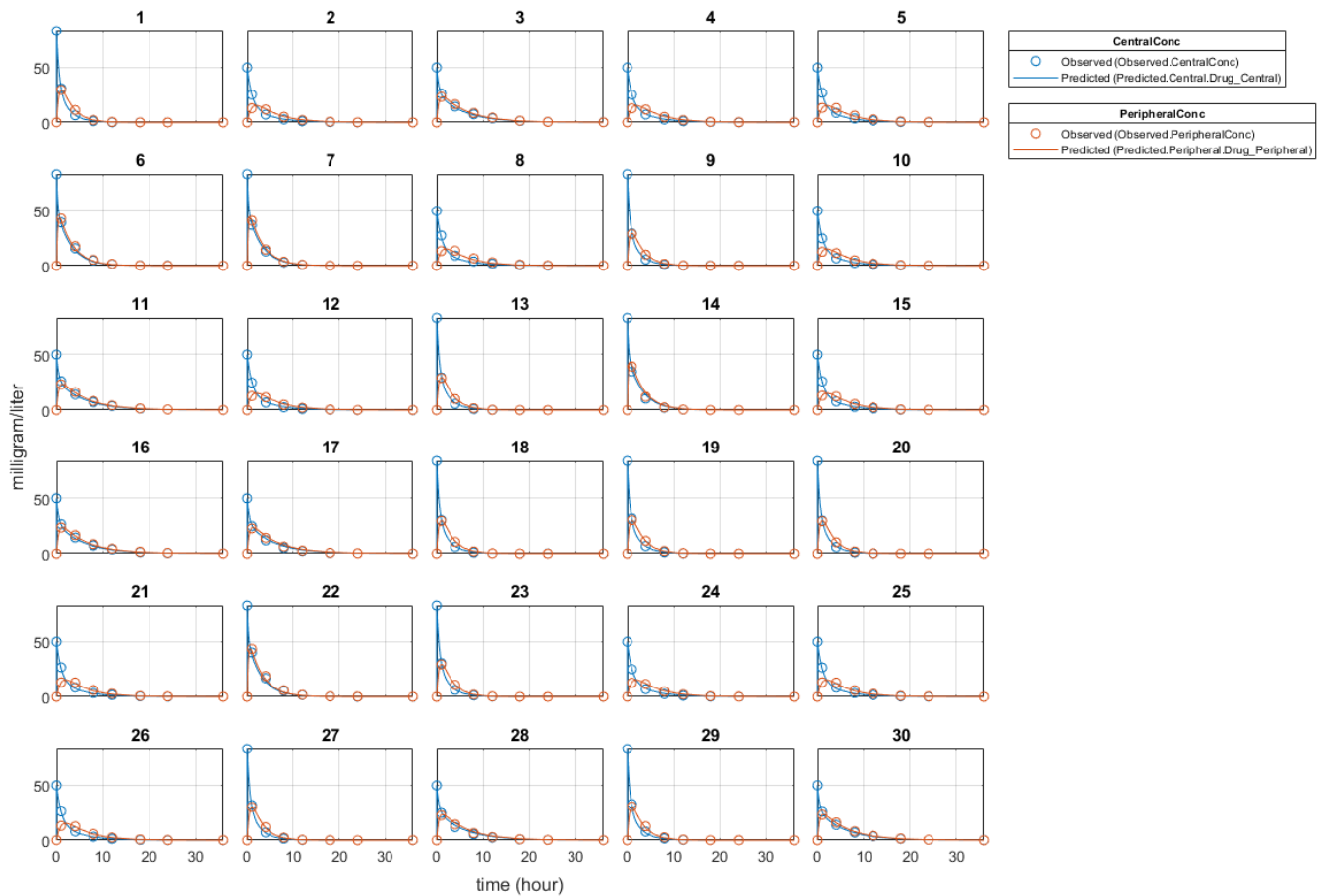

For the `CL_Central` and `Q12` parameters, all males had the same estimates, and similarly for the females. For the `Central` and `Peripheral` parameters, all young individuals had the same estimates, and similarly for the old individuals.

Estimate Population-Wide Parameters

To better compare the results, fit the model to all of the data pooled together, that is, estimate one set of parameters for all individuals by setting the `'Pooled'` name-value pair argument to `true`. The warning message tells you that this option will ignore any category-specific information (if they exist).

```
pooledFit = sbiofit(model,gData,responseMap,estimatedParam,dose,'Pooled',true);
```

Warning: `CategoryVariableName` property of the `estimatedInfo` object is ignored when using the `'Pooled'`

Plot Results

Plot the fitted results versus the original data. Although a separate plot was generated for each individual, the data was fitted using the same set of parameters (that is, all individuals had the same fitted line).

```
plot(pooledFit);
```

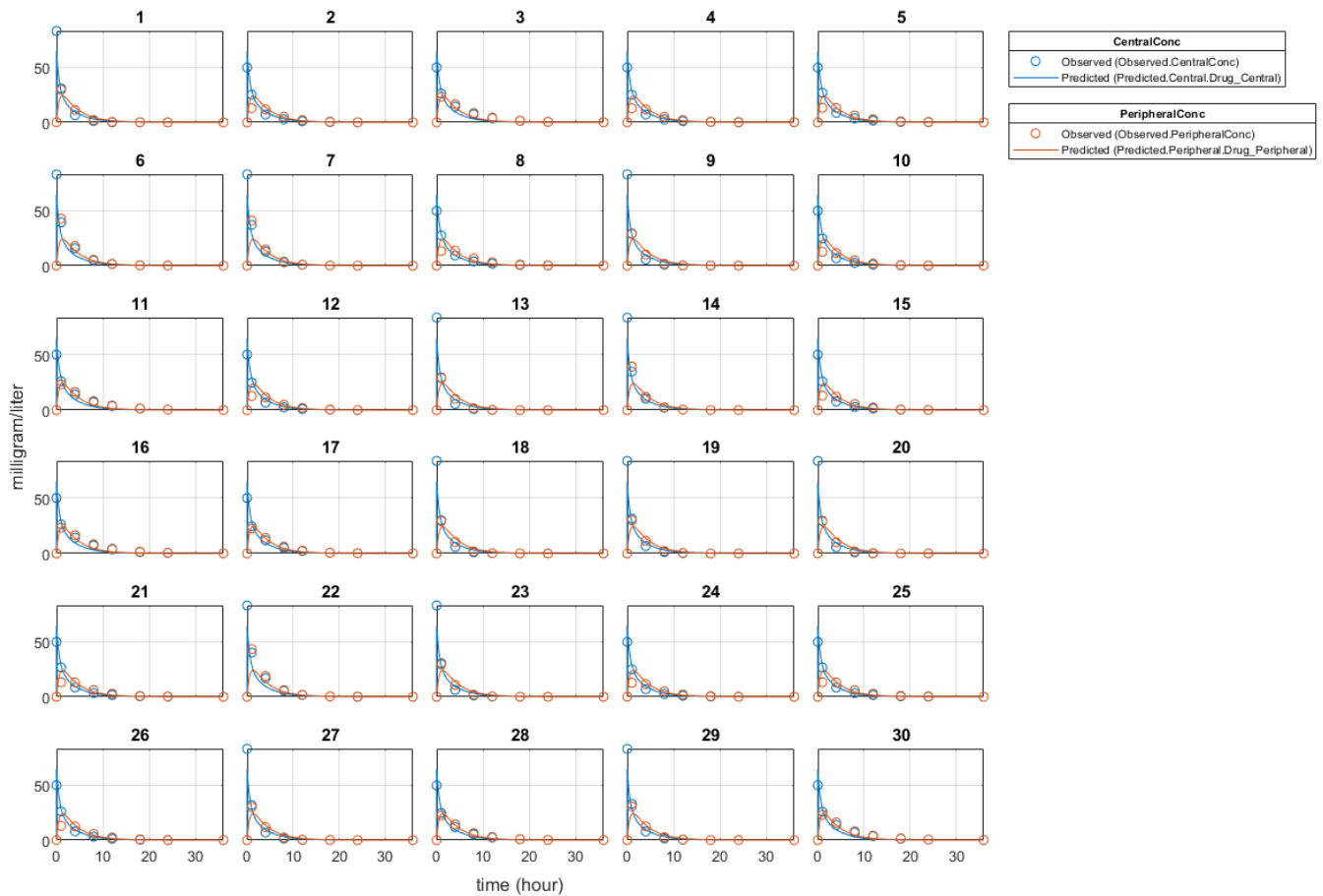

Compare Residuals

Compare residuals of CentralConc and PeripheralConc responses for each fit.

```
t = gData.Time;
allResid(:, :, 1) = pooledFit.R;
allResid(:, :, 2) = categoryFit.R;
allResid(:, :, 3) = vertcat(unpooledFit.R);

h = figure;
responseList = {'CentralConc', 'PeripheralConc'};
for i = 1:2
    subplot(2,1,i);
    oneResid = squeeze(allResid(:, i, :));
    plot(t, oneResid, 'o');
    reffline(0,0); % A reference line representing a zero residual
    title(sprintf('Residuals (%s)', responseList{i}));
    xlabel('Time');
    ylabel('Residuals');
    legend({'Pooled', 'Category-Specific', 'Unpooled'});
end
% Resize the figure.
h.Position(:) = [100 100 1280 800];
```

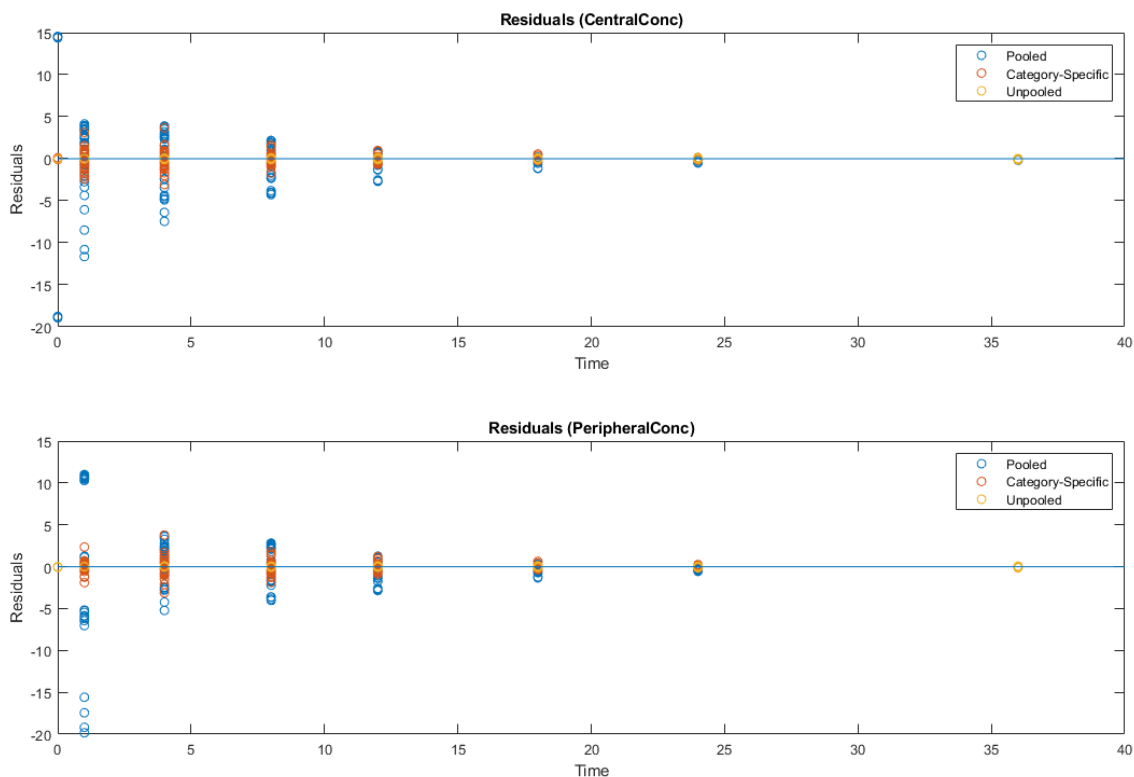

As shown in the plot, the unpooled fit produced the best fit to the data as it fit the data to each individual. This was expected since it used the most number of degrees of freedom. The category-fit reduced the number of degrees of freedom by fitting the data to two categories (sex and age). As a result, the residuals were larger than the unpooled fit, but still smaller than the population-fit, which estimated just one set of parameters for all individuals. The category-fit might be a good compromise between the unpooled and pooled fitting provided that any hierarchical model exists within your data.

See Also

`sbiofit`

More About

- “Fit One-Compartment Model to Individual PK Profile” on page 4-52
- “Fit a Two-Compartment Model to PK Profiles of Multiple Individuals” on page 4-71
- “Nonlinear Regression” on page 4-35

Perform Hybrid Optimization Using sbiofit

This example shows how to configure `sbiofit` to perform a hybrid optimization by first running the global solver `particleswarm`, followed by another minimization function, `fmincon`.

Load Data

Load the sample data to fit. The data is stored as a table with variables `ID`, `Time`, `CentralConc`, and `PeripheralConc`. This synthetic data represents the time course of plasma concentrations measured at eight different time points for both central and peripheral compartments after an infusion dose for three individuals. The dose amount is 100 milligram and dose rate is 50 milligram/hour.

```
load('data10_32R.mat')
gData = groupedData(data);
gData.Properties.VariableUnits = {'','hour','milligram/liter','milligram/liter'};
sbiofit(gData,'ID','Time',{'CentralConc','PeripheralConc'},'Marker','+',...
        'LineStyle','none');
```

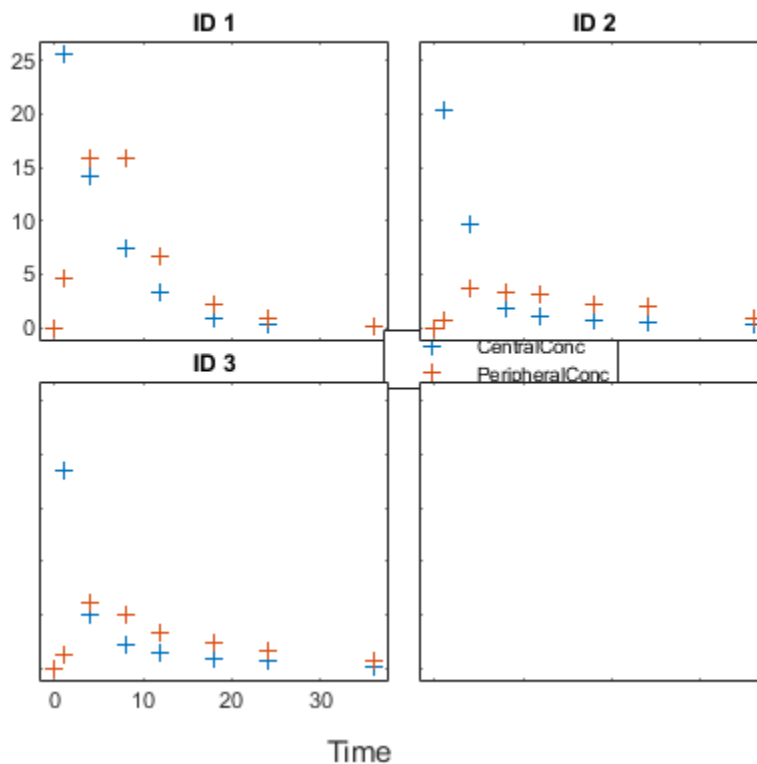

Create Model

Create a two-compartment model with an infusion dose.

```
pkmd = PKModelDesign;
pkc1 = addCompartment(pkmd,'Central');
pkc1.DosingType = 'Infusion';
pkc1.EliminationType = 'linear-clearance';
pkc1.HasResponseVariable = true;
```

```
pkc2          = addCompartment(pkmd, 'Peripheral');
model        = construct(pkmd);
configset    = getConfigset(model);
configset.CompileOptions.UnitConversion = true;
dose         = sbiodose('dose', 'TargetName', 'Drug_Central');
dose.StartTime = 0;
dose.Amount   = 100;
dose.Rate     = 50;
dose.AmountUnits = 'milligram';
dose.TimeUnits  = 'hour';
dose.RateUnits  = 'milligram/hour';
responseMap = {'Drug_Central = CentralConc', 'Drug_Peripheral = PeripheralConc'};
```

Define Parameters to Estimate

Use the `estimatedInfo` object to define the estimated parameters.

```
paramsToEstimate = {'log(Central)', 'log(Peripheral)', 'Q12', 'Cl_Central'};
estimatedParam   = estimatedInfo(paramsToEstimate, 'InitialValue', [1 1 1 1], ...
                                'Bounds', [0 10]);
```

Define the Options for Hybrid Optimization

Define the options for the global solver and the hybrid solver. Because the parameters are bounded, make sure you use a compatible hybrid function for a constrained optimization, such as `fmincon`. Use `optimset` to define the options for `fminsearch`. Use `optimoptions` to define the options for `fminunc`, `patternsearch`, and `fmincon`.

```
rng('default');
globalMethod = 'particleswarm';
options = optimoptions(globalMethod);
hybridMethod = 'fmincon';
hybridopts = optimoptions(hybridMethod, 'Display', 'none');
options = optimoptions(options, 'HybridFcn', {hybridMethod, hybridopts});
```

Fit Data

Estimate model parameters. Turn on `ProgressPlot` to see the live feedback on the status of fitting. The first row of plots are the quality measure plots for the global solver. The second row plots are for the hybrid function. For details, see “Progress Plot” on page 4-45.

```
unpooledFit = sbiofit(model, gData, responseMap, estimatedParam, dose, globalMethod, ...
                    options, 'Pooled', false, 'ProgressPlot', true);
```

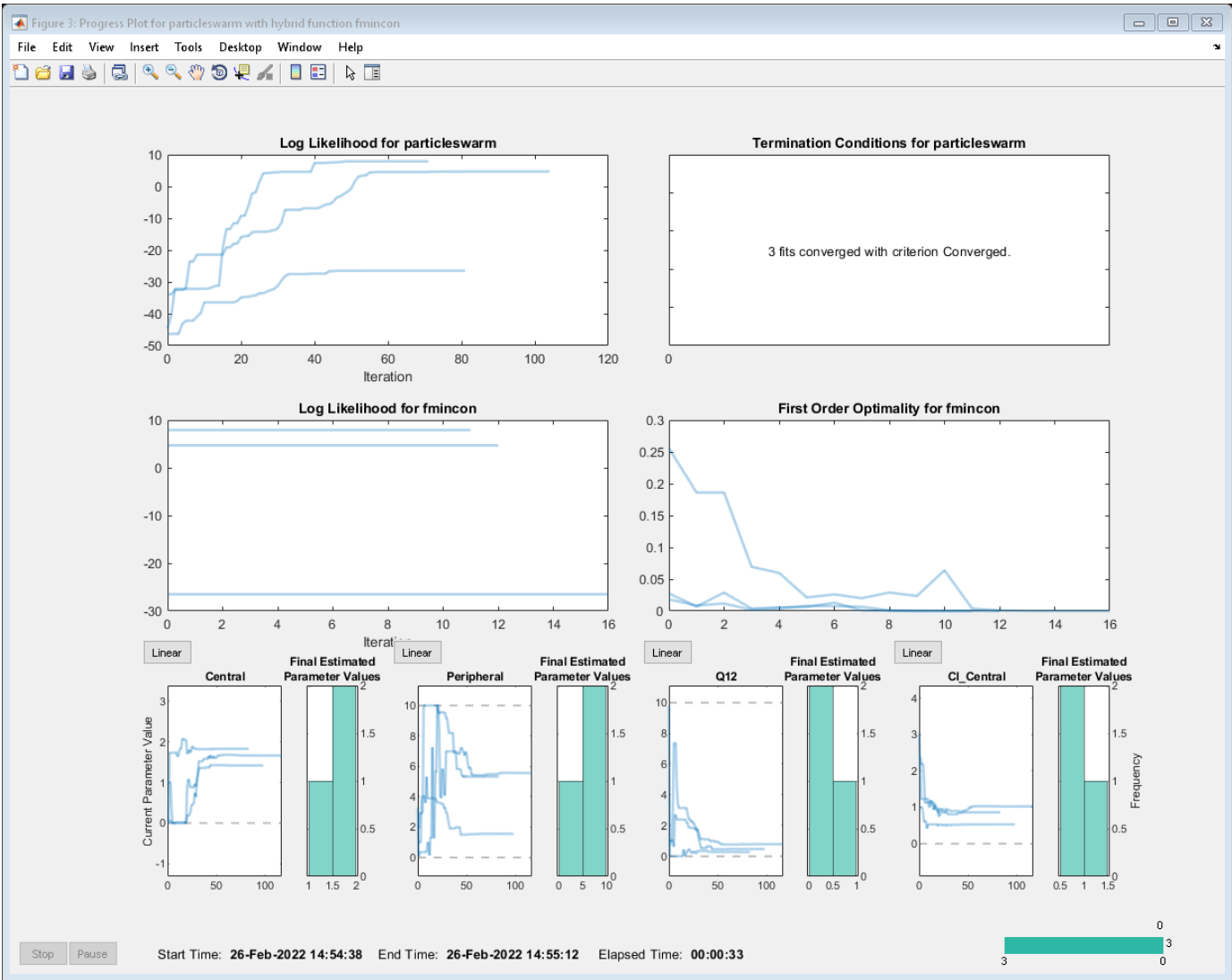
Plot Results

```
plot(unpooledFit);
```

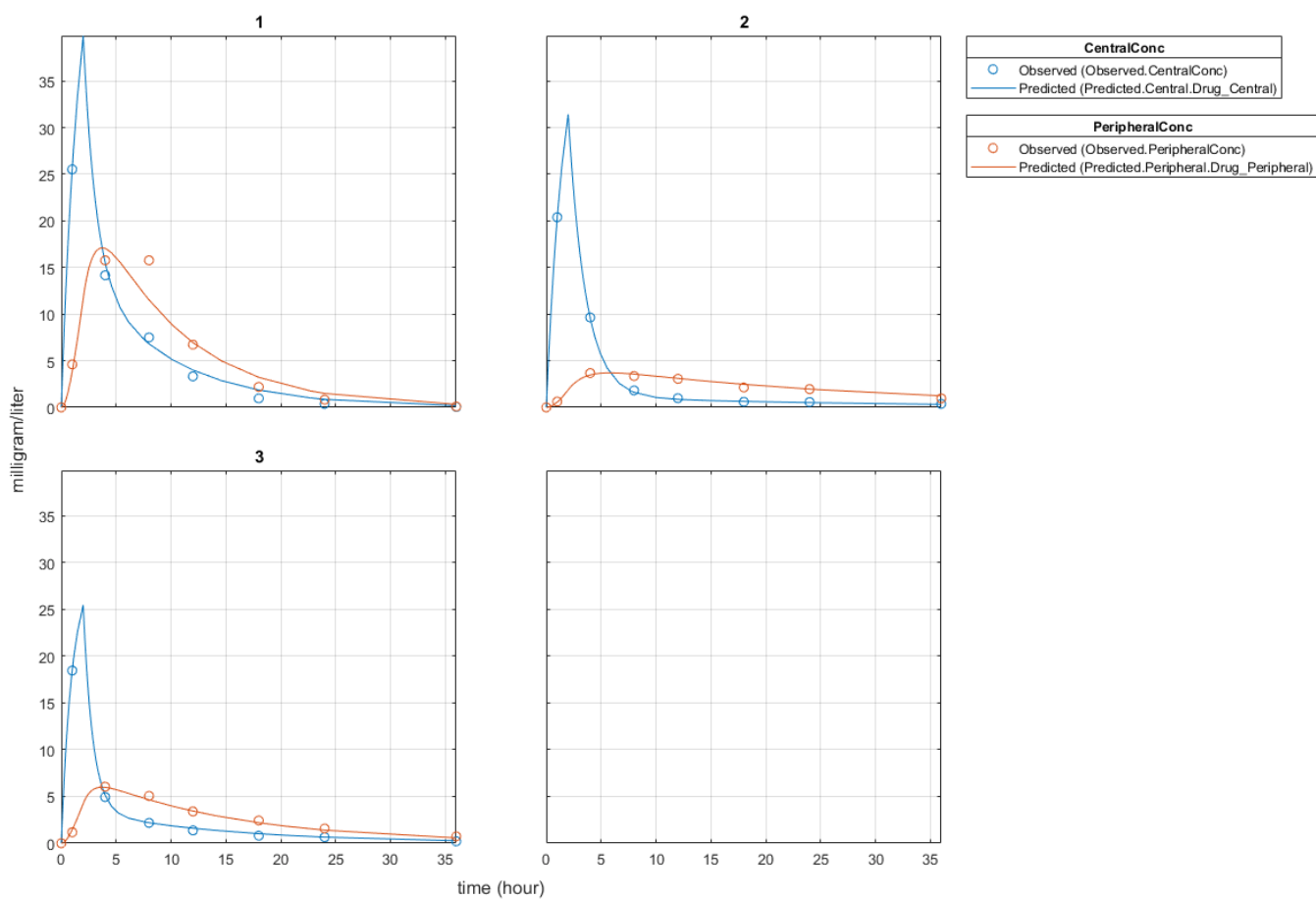

See Also
 sbiofit

More About

- “Fit One-Compartment Model to Individual PK Profile” on page 4-52
- “Fit a Two-Compartment Model to PK Profiles of Multiple Individuals” on page 4-71
- “Nonlinear Regression” on page 4-35

Fit a Two-Compartment Model to PK Profiles of Multiple Individuals

This example shows how to estimate pharmacokinetic parameters of multiple individuals using a two-compartment model.

Suppose you have drug plasma concentration data from three individuals that you want to use to estimate corresponding pharmacokinetic parameters, namely the volume of central and peripheral compartment (`Central`, `Peripheral`), the clearance rate (`Cl_Central`), and intercompartmental clearance (`Q12`). Assume the drug concentration versus the time profile follows the biexponential decline $C_t = Ae^{-at} + Be^{-bt}$, where C_t is the drug concentration at time t , and a and b are slopes for corresponding exponential declines.

The synthetic data set contains drug plasma concentration data measured in both central and peripheral compartments. The data was generated using a two-compartment model with an infusion dose and first-order elimination. These parameters were used for each individual.

	Central	Peripheral	Q12	Cl_Central
Individual 1	1.90	0.68	0.24	0.57
Individual 2	2.10	6.05	0.36	0.95
Individual 3	1.70	4.21	0.46	0.95

The data is stored as a table with variables `ID`, `Time`, `CentralConc`, and `PeripheralConc`. It represents the time course of plasma concentrations measured at eight different time points for both central and peripheral compartments after an infusion dose.

```
load('data10_32R.mat')
```

Convert the data set to a `groupedData` object which is the required data format for the fitting function `sbiofit` for later use. A `groupedData` object also lets you set independent variable and group variable names (if they exist). Set the units of the `ID`, `Time`, `CentralConc`, and `PeripheralConc` variables. The units are optional and only required for the `UnitConversion` feature, which automatically converts matching physical quantities to one consistent unit system.

```
gData = groupedData(data);
gData.Properties.VariableUnits = {'','hour','milligram/liter','milligram/liter'};
gData.Properties
```

```
ans =
```

```
struct with fields:
```

```

    Description: ''
      UserData: []
 DimensionNames: {'Row' 'Variables'}
  VariableNames: {'ID' 'Time' 'CentralConc' 'PeripheralConc'}
VariableDescriptions: {}
   VariableUnits: {1x4 cell}
 VariableContinuity: []
      RowNames: {}
 CustomProperties: [1x1 matlab.tabular.CustomProperties]
 GroupVariableName: 'ID'
```

```
IndependentVariableName: 'Time'
```

Create a trellis plot that shows the PK profiles of three individuals.

```
sbiotrellis(gData, 'ID', 'Time', {'CentralConc', 'PeripheralConc'}, ...
            'Marker', '+', 'LineStyle', 'none');
```

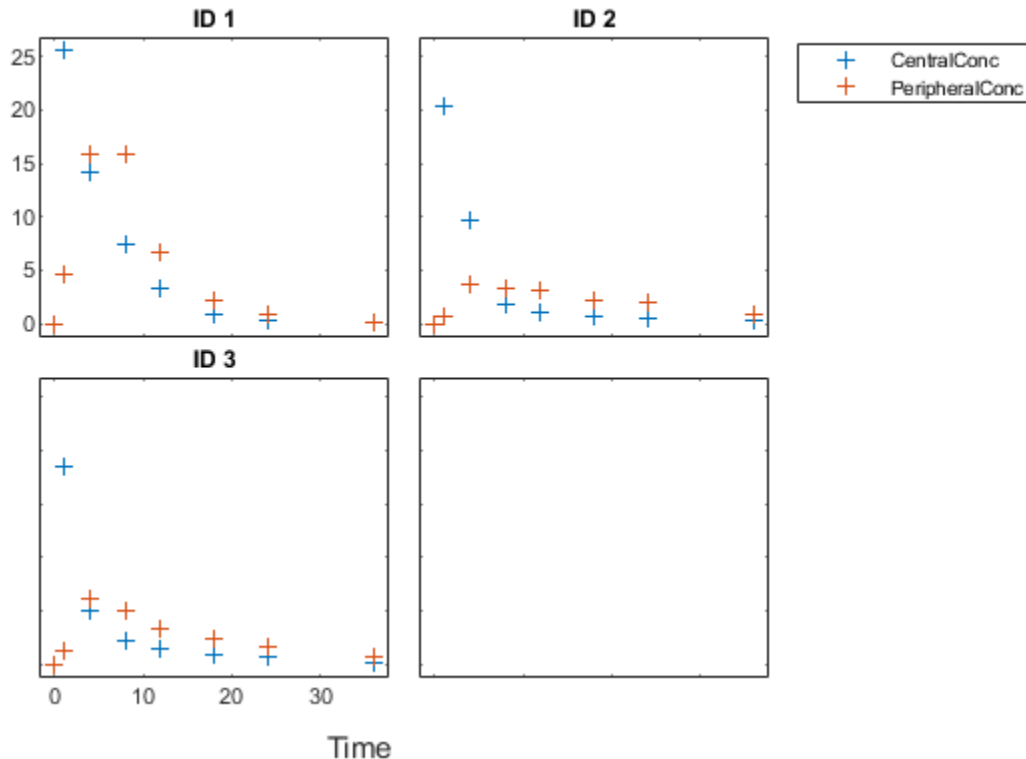

Use the built-in PK library to construct a two-compartment model with infusion dosing and first-order elimination where the elimination rate depends on the clearance and volume of the central compartment. Use the configset object to turn on unit conversion.

```
pkmd          = PKModelDesign;
pkc1          = addCompartment(pkmd, 'Central');
pkc1.DosingType = 'Infusion';
pkc1.EliminationType = 'linear-clearance';
pkc1.HasResponseVariable = true;
pkc2          = addCompartment(pkmd, 'Peripheral');
model         = construct(pkmd);
configset     = getConfigset(model);
configset.CompileOptions.UnitConversion = true;
```

Assume every individual receives an infusion dose at time = 0, with a total infusion amount of 100 mg at a rate of 50 mg/hour. For details on setting up different dosing strategies, see “Doses in SimBiology Models” on page 2-30.

```
dose          = sbiodose('dose', 'TargetName', 'Drug_Central');
dose.StartTime = 0;
```

```
dose.Amount      = 100;
dose.Rate        = 50;
dose.AmountUnits = 'milligram';
dose.TimeUnits   = 'hour';
dose.RateUnits   = 'milligram/hour';
```

The data contains measured plasma concentrations in the central and peripheral compartments. Map these variables to the appropriate model species, which are `Drug_Central` and `Drug_Peripheral`.

```
responseMap = {'Drug_Central = CentralConc', 'Drug_Peripheral = PeripheralConc'};
```

The parameters to estimate in this model are the volumes of central and peripheral compartments (`Central` and `Peripheral`), intercompartmental clearance `Q12`, and clearance rate `Cl_Central`. In this case, specify log-transform for `Central` and `Peripheral` since they are constrained to be positive. The `estimatedInfo` object lets you specify parameter transforms, initial values, and parameter bounds (optional).

```
paramsToEstimate = {'log(Central)', 'log(Peripheral)', 'Q12', 'Cl_Central'};
estimatedParam   = estimatedInfo(paramsToEstimate, 'InitialValue', [1 1 1 1]);
```

Fit the model to all of the data pooled together, that is, estimate one set of parameters for all individuals. The default estimation method that `sbiofit` uses will change depending on which toolboxes are available. To see which estimation function `sbiofit` used for the fitting, check the `EstimationFunction` property of the corresponding results object.

```
pooledFit = sbiofit(model, gData, responseMap, estimatedParam, dose, 'Pooled', true)
```

```
pooledFit =
```

```
  OptimResults with properties:
```

```
      ExitFlag: 3
      Output: [1x1 struct]
      GroupName: []
      Beta: [4x3 table]
      ParameterEstimates: [4x3 table]
      J: [24x4x2 double]
      COVB: [4x4 double]
      CovarianceMatrix: [4x4 double]
      R: [24x2 double]
      MSE: 6.6220
      SSE: 291.3688
      Weights: []
      LogLikelihood: -111.3904
      AIC: 230.7808
      BIC: 238.2656
      DFE: 44
      DependentFiles: {1x3 cell}
      EstimatedParameterNames: {'Central' 'Peripheral' 'Q12' 'Cl_Central'}
      ErrorModelInfo: [1x3 table]
      EstimationFunction: 'lsqnonlin'
```

Plot the fitted results versus the original data. Although three separate plots were generated, the data was fitted using the same set of parameters (that is, all three individuals had the same fitted line).

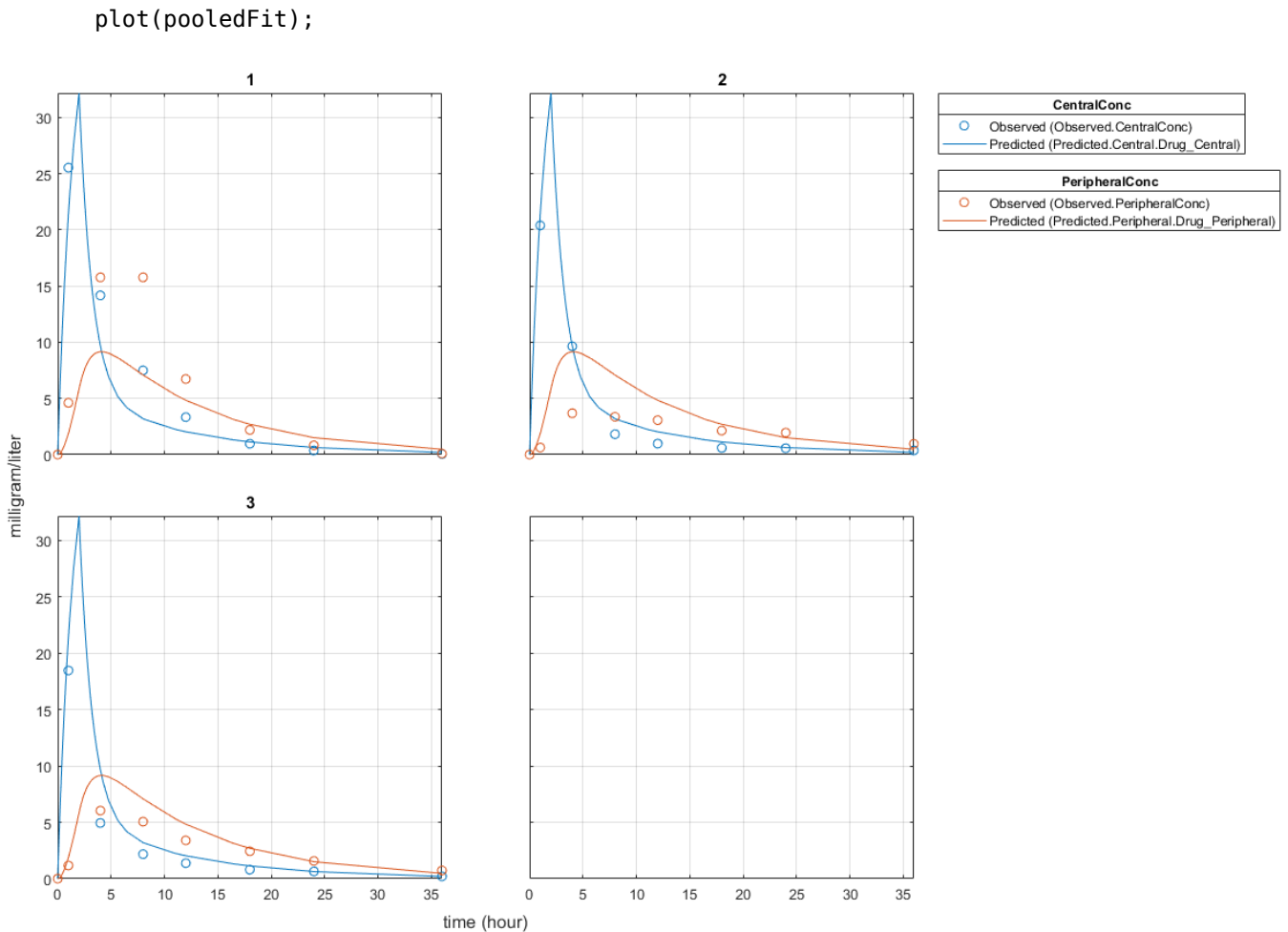

Estimate one set of parameters for each individual and see if there is any improvement in the parameter estimates. In this example, since there are three individuals, three sets of parameters are estimated.

```
unpooledFit = sbiofit(model,gData,responseMap,estimatedParam,dose,'Pooled',false);
```

Plot the fitted results versus the original data. Each individual was fitted differently (that is, each fitted line is unique to each individual) and each line appeared to fit well to individual data.

```
plot(unpooledFit);
```

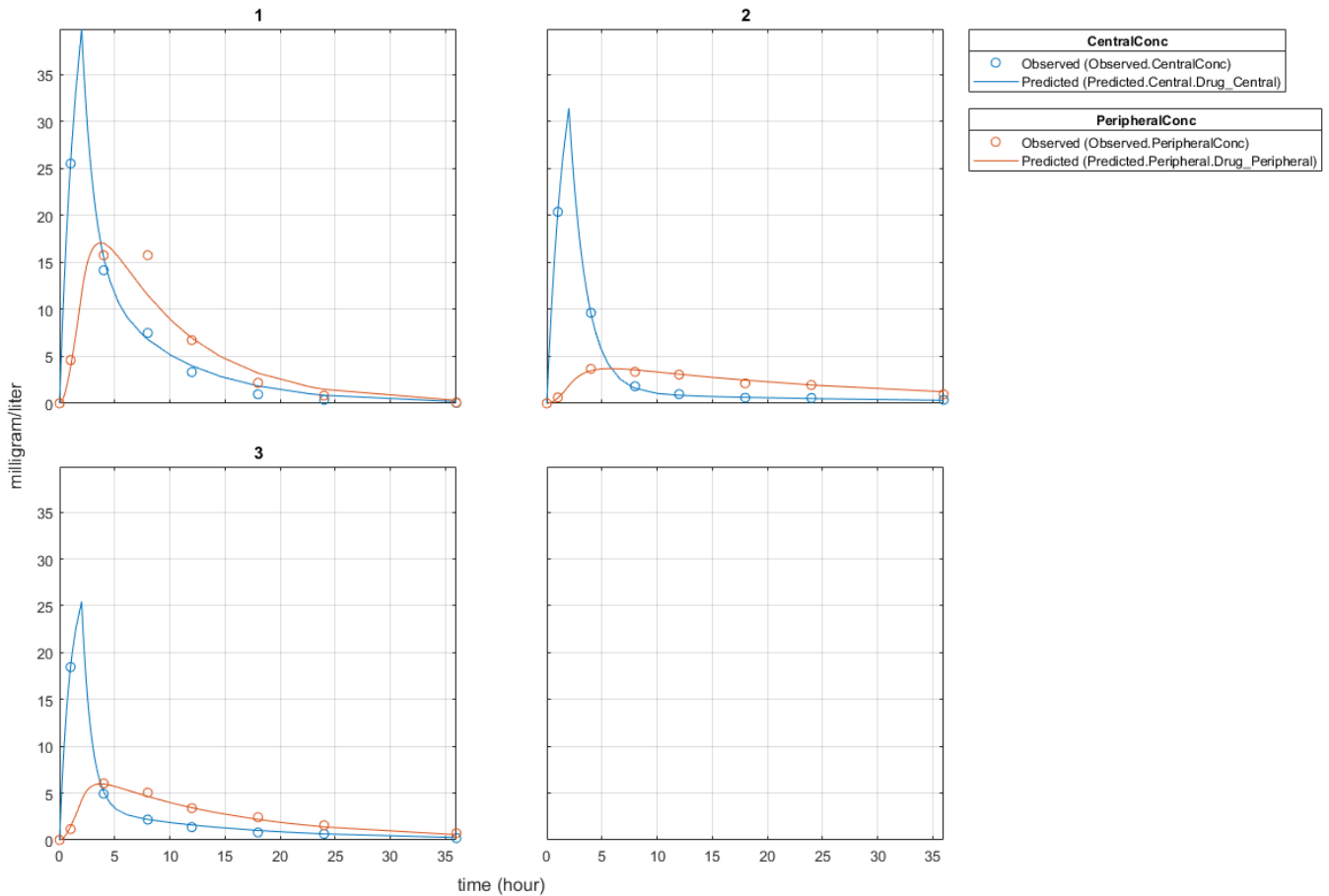

Display the fitted results of the first individual. The MSE was lower than that of the pooled fit. This is also true for the other two individuals.

```
unpooledFit(1)
```

```
ans =
```

```
OptimResults with properties:
```

```

ExitFlag: 3
Output: [1x1 struct]
GroupName: 1
Beta: [4x3 table]
ParameterEstimates: [4x3 table]
J: [8x4x2 double]
COVB: [4x4 double]
CovarianceMatrix: [4x4 double]
R: [8x2 double]
MSE: 2.1380
SSE: 25.6559
Weights: []
LogLikelihood: -26.4805
AIC: 60.9610
BIC: 64.0514

```

```

                DFE: 12
    DependentFiles: {1x3 cell}
    EstimatedParameterNames: {'Central' 'Peripheral' 'Q12' 'Cl_Central'}
    ErrorModelInfo: [1x3 table]
    EstimationFunction: 'lsqnonlin'
    
```

Generate a plot of the residuals over time to compare the pooled and unpooled fit results. The figure indicates unpooled fit residuals are smaller than those of pooled fit as expected. In addition to comparing residuals, other rigorous criteria can be used to compare the fitted results.

```

t = [gData.Time;gData.Time];
res_pooled = vertcat(pooledFit.R);
res_pooled = res_pooled(:);
res_unpooled = vertcat(unpooledFit.R);
res_unpooled = res_unpooled(:);
plot(t,res_pooled,'o','MarkerFaceColor','w','markerEdgeColor','b')
hold on
plot(t,res_unpooled,'o','MarkerFaceColor','b','markerEdgeColor','b')
refl = refline(0,0); % A reference line representing a zero residual
title('Residuals versus Time');
xlabel('Time');
ylabel('Residuals');
legend({'Pooled','Unpooled'});
    
```

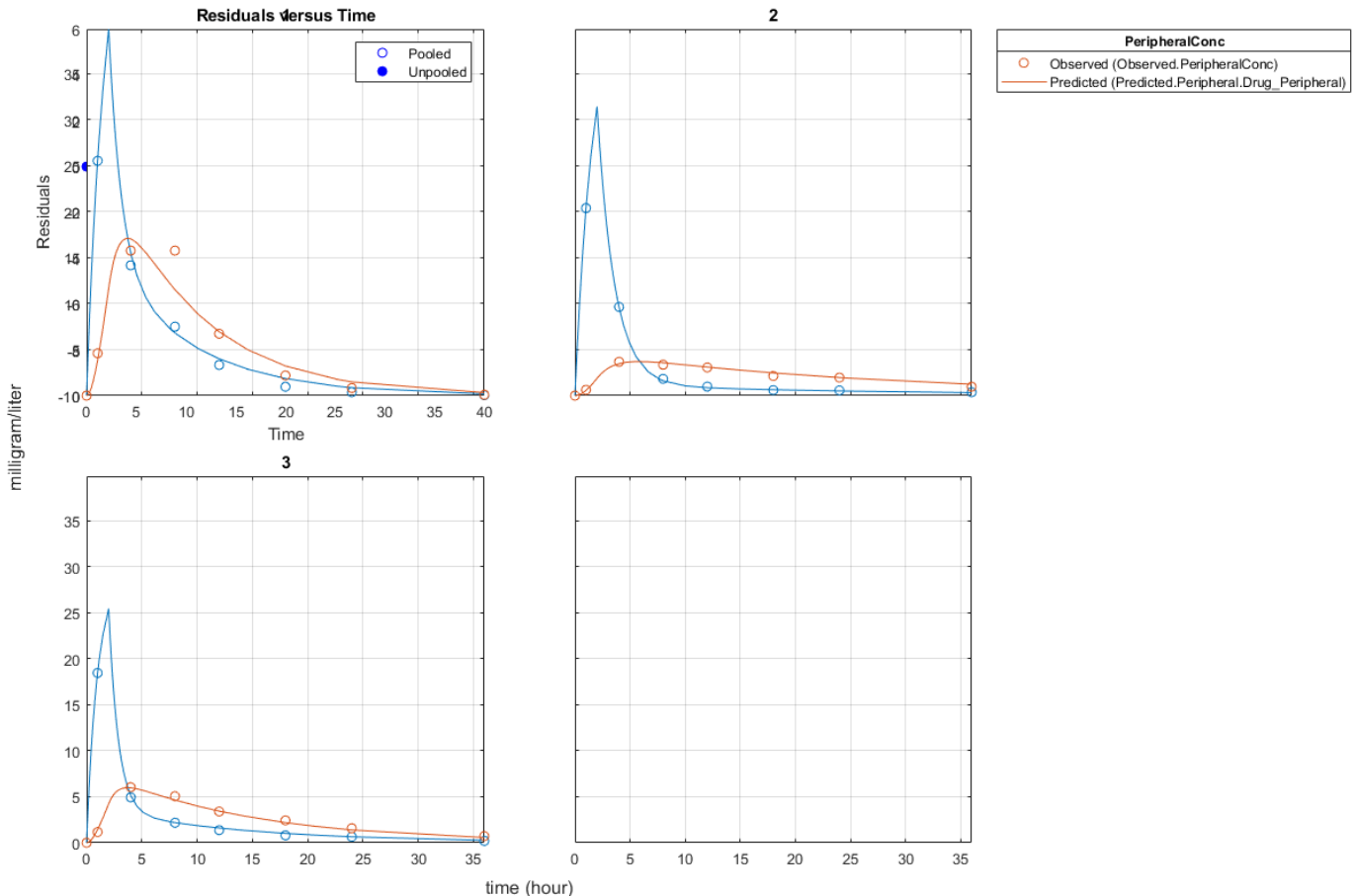

This example showed how to perform pooled and unpooled estimations using `sbiofit`. As illustrated, the unpooled fit accounts for variations due to the specific subjects in the study, and, in this case, the model fits better to the data. However, the pooled fit returns population-wide parameters. If you want to estimate population-wide parameters while considering individual variations, use `sbiofitmixed`.

See Also

`sbiofit`

More About

- “Fit One-Compartment Model to Individual PK Profile” on page 4-52
- “Estimate Category-Specific PK Parameters for Multiple Individuals” on page 4-58
- “Nonlinear Regression” on page 4-35

Estimating the Bioavailability of a Drug

In this example, you will use the parameter estimation capabilities of SimBiology™ to calculate F , the bioavailability, of the drug ondansetron. You will calculate F by fitting a model of absorption and excretion of the drug to experimental data tracking drug concentration over time.

This example requires Optimization Toolbox™.

Background

Most drugs must be absorbed into the bloodstream in order to become active. An intravenous (IV) administration of a drug is one way to achieve this. However, it is impractical or impossible in many cases.

When a drug is not given by IV, it follows some other route into the bloodstream, such as absorption through the mucous membranes of the GI tract or mouth. Drugs administered through a route other than IV administration are generally not completely absorbed. Some portion of the drug is directly eliminated and never reaches the bloodstream.

The percentage of drug absorbed is the bioavailability of the drug. Bioavailability is one of the most important pharmacokinetic properties of a drug. It is useful when calculating safe dosages for non-IV routes of administration. Bioavailability is calculated relative to an IV administration. When administered intravenously, a drug has 100% bioavailability. Other routes of administration tend to reduce the amount of drug that reaches the blood stream.

Modeling Bioavailability

Bioavailability can be modeled using one of several approaches. In this example, you use a model with a GI compartment and a blood plasma compartment. Oral administration is modeled by a dose event in the GI compartment. IV administration is modeled by a dose event in the blood plasma compartment.

The example models the drug leaving the GI compartment in two ways. The available fraction of the drug is absorbed into the bloodstream. The remainder is directly eliminated. The total rate of elimination, ka , is divided into absorption, $ka_Central$, and direct elimination, Cl_Oral . The bioavailability, F , connects total elimination with $ka_Central$ and Cl_Oral via two initial assignment rules.

$$\begin{aligned}ka_Central &= F*ka \\Cl_Oral &= (1-F)*ka\end{aligned}$$

The drug is eliminated from the `Blood_Plasma` compartment through first-order kinetics, at a rate determined by the parameter `Cl_Central`.

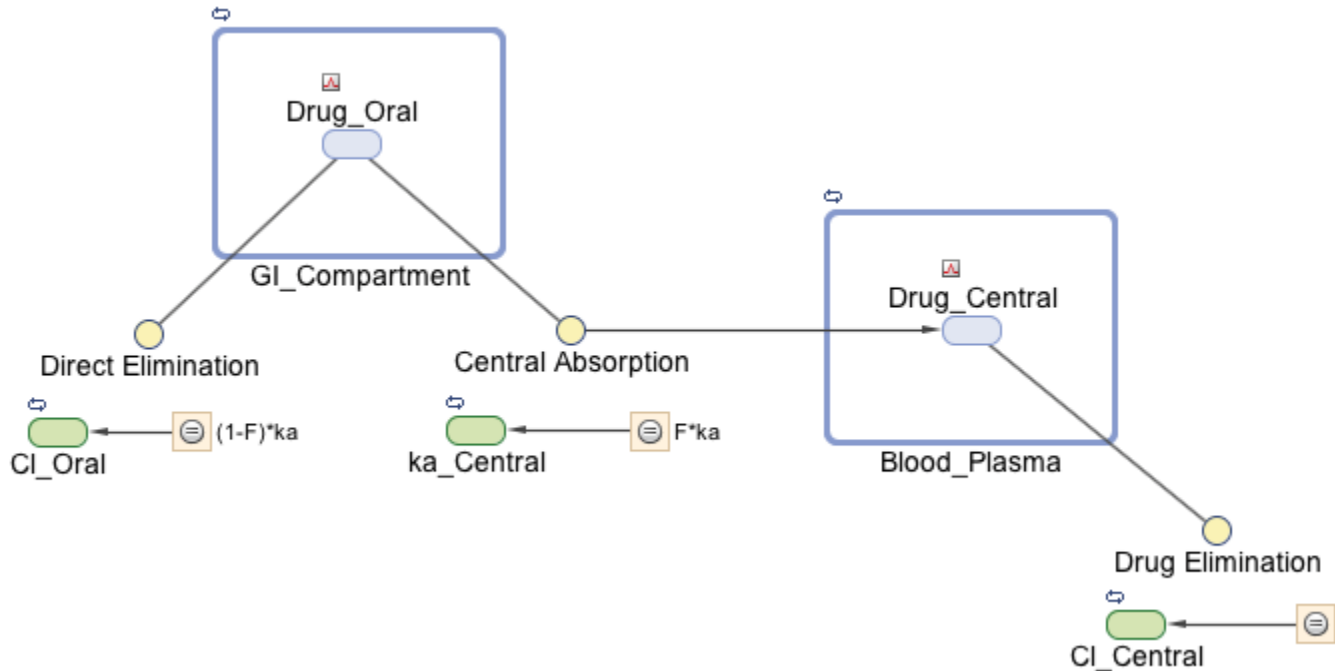

Load the project that contains the model m1.

```
sbioloadproject('Bioavailability.sbproj', 'm1');
```

Format of the Data for Estimating Bioavailability

You can estimate bioavailability by comparing inpatient measurements of drug concentration under different dosing conditions. For instance, a patient receives an IV dose on day 1, then receives an oral dose on day 2. On both days, we can measure the blood plasma concentration of the drug over some period of time.

Such data allow us to estimate the bioavailability, as well as other parameters of the model. Inpatient time courses were generated for the drug ondansetron, reported in [2] and reproduced in [1].

Load the data, which is a table.

```
load('ondansetron_data.mat');
```

Convert the data to a `groupedData` object because the fitting function `sbiofit` requires it to be a `groupedData` object.

```
gd = groupedData(ondansetron_data);
```

Display the data.

```
gd
```

```
gd =
```

```
33x5 groupedData
```

Time	Drug	Group	IV	Oral
0	NaN	1	8	NaN
0.024358	69.636	1	NaN	NaN
0.087639	58.744	1	NaN	NaN
0.15834	49.824	1	NaN	NaN
0.38895	44.409	1	NaN	NaN
:	:	:	:	:
4.9309	10.346	2	NaN	NaN
6.1155	7.4489	2	NaN	NaN
8.0002	5.1919	2	NaN	NaN
10.091	2.9058	2	NaN	NaN
12.228	1.6808	2	NaN	NaN

Display all 33 rows.

The data have variables for time, drug concentration, grouping information, IV, and oral dose amounts. Group 1 contains the data for the IV time course. Group 2 contains the data for the oral time course. NaN in the Drug column means no measurement was made at that time. NaN in one of the dosing columns means no dose was given through that route at that time.

Plot the pharmacokinetic profiles of the oral dose and IV administration.

```
plot(gd.Time(gd.Group==1),gd.Drug(gd.Group==1),'Marker','+')
hold on
plot(gd.Time(gd.Group==2),gd.Drug(gd.Group==2),'Marker','x')
legend({'8 mg IV','8 mg Oral'})
xlabel('Time (hour)')
ylabel('Concentration (milligram/liter)')
```

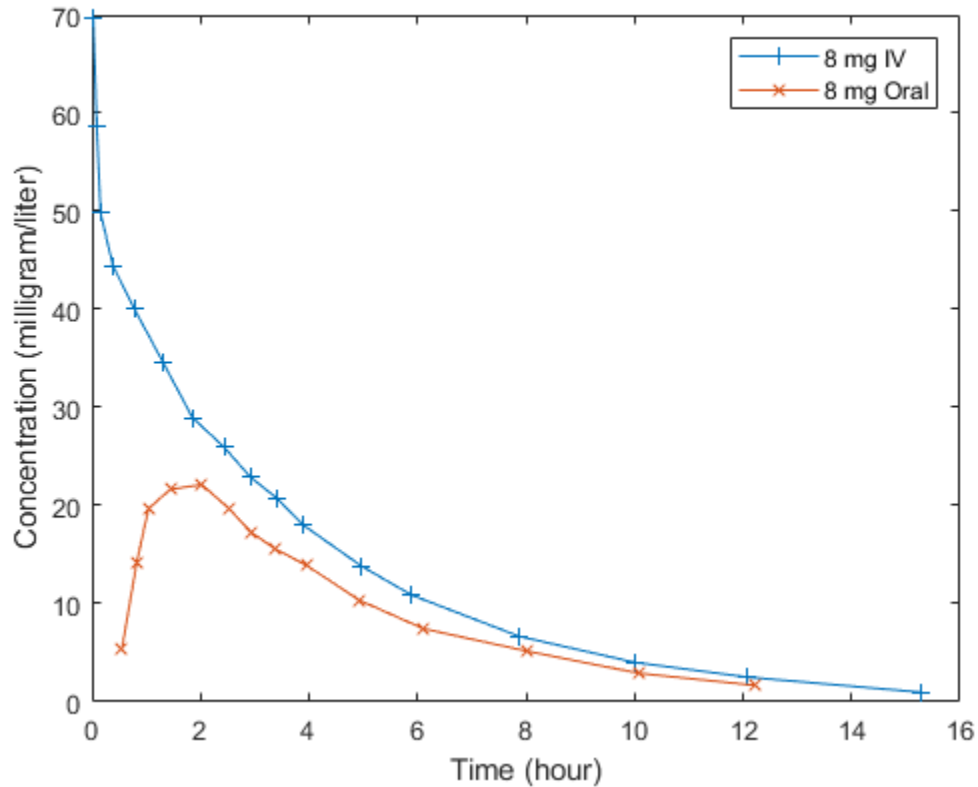

Notice there is a lag phase in the oral dose of about an hour while the drug is absorbed from the GI tract into the bloodstream.

Fitting the Data

Estimate the following four parameters of the model:

- Total forward rate out of the dose compartment, k_a
- Clearance from the Blood_Plasma compartment, $clearance$
- Volume of the Blood_Plasma compartment
- Bioavailability of the orally administered drug, F

Set the initial values of these parameters and specify the log transform for all parameters using an `estimatedInfo` object.

```
init = [1 1 2 .8];
estimated_parameters = estimatedInfo({'log(ka)', 'log(clearance)', ...
    'log(Blood_Plasma)', 'logit(F)'}, 'InitialValue', init);
```

Because k_a , $clearance$, and `Blood_Plasma` are positive physical quantities, log transforming reflects the underlying physical constraint and generally improves fitting. This example uses a logit transform on F because it is a quantity constrained between 0 and 1. The logit transform takes the interval of 0 to 1 and transforms it by taking the log-odds of F (treating F as a probability). For a few drugs, like theophylline, constraining F between 0 and 1 is inappropriate because oral bioavailability can be greater than 1 for drugs with unusual absorption or metabolism mechanisms.

Next, map the response data to the corresponding model component. In the model, the plasma drug concentration is represented by `Blood_Plasma.Drug_Central`. The corresponding concentration data is the `Drug` variable of the `groupedData` object `gd`.

```
responseMap = {'Blood_Plasma.Drug_Central = Drug'};
```

Create the dose objects required by `sbiofit` to handle the dosing information. First, create the IV dose targeting `Drug_Central` and the oral dose targeting `Dose_Central`.

```
iv_dose = sbiodose('IV', 'TargetName', 'Drug_Central');  
oral_dose = sbiodose('Oral', 'TargetName', 'Drug_Oral');
```

Use these dose objects as template doses to generate an array of dose objects from the dosing data variables `IV` and `Oral`.

```
doses_for_fit = createDoses(gd, {'IV', 'Oral'}, '', [iv_dose, oral_dose]);
```

Estimate parameters using `sbiofit`.

```
opts = optimoptions('lsqnonlin', 'Display', 'final');  
results = sbiofit(m1, gd, responseMap, estimated_parameters, doses_for_fit, ...  
    'lsqnonlin', opts, [], 'pooled', true);
```

Local minimum possible.

`lsqnonlin` stopped because the final change in the sum of squares relative to its initial value is less than the value of the function tolerance.

Interpreting Results

First, check if the fit is successful.

```
plot(results)
```

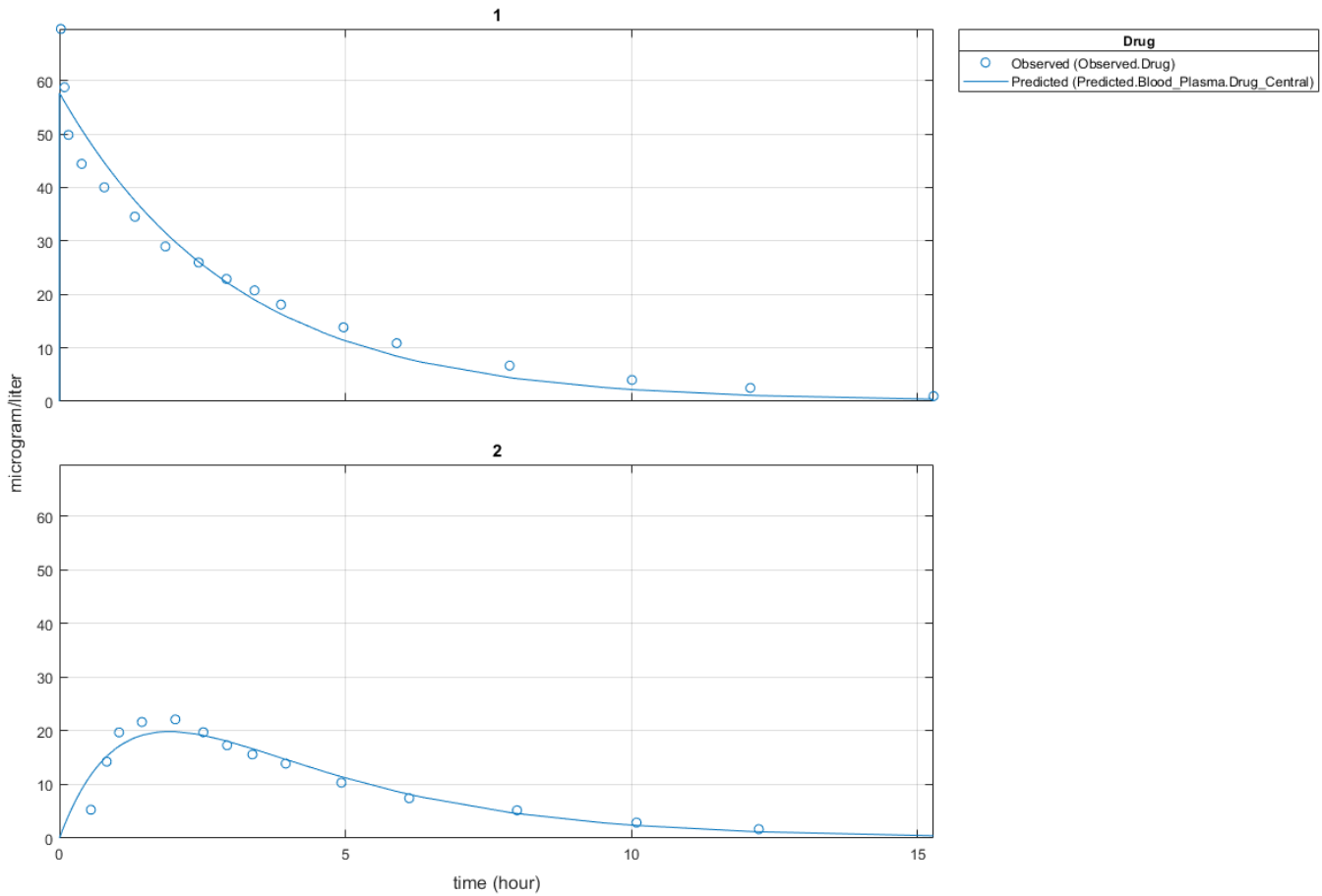

Overall, the results seem to be a good fit. However, they do not capture a distribution phase over the first hour. It might be possible to improve the fit by adding another compartment, but more data would be required to justify such an increase in model complexity.

When satisfied with the model fit, you can draw conclusions about the estimated parameters. Display the parameters stored in the results object.

```
results.ParameterEstimates
```

```
ans=4x3 table
```

Name	Estimate	StandardError
{'ka' }	0.77947	0.1786
{'clearance' }	45.19	2.8674
{'Blood_Plasma' }	138.73	4.5249
{'F' }	0.64455	0.066013

The parameter F is the bioavailability. The result indicates that ondansetron has approximately a 64% bioavailability. This estimate is in line with the literature reports that oral administration of ondansetron in the 2-24 milligram range has a 60% bioavailability [1,2].

Blood_Plasma is the volume of distribution. This result is reasonably close to the 160 liter Vd reported for ondansetron [1]. The estimated clearance is 45.4 L/hr.

k_a does not map directly onto a widely reported pharmacokinetic parameter. Consider it from two perspectives. We can say that 64% of the drug is available, and that the available drug has an absorption parameter of 0.4905/hr. Or, we can say that drug clearance from the GI compartment is 0.7402/hr, and 64% of the drug cleared from the GI tract is absorbed into the bloodstream.

Generalizing This Approach

`lsqnonlin`, as well as several other optimization algorithms supported by `sbiofit`, are local algorithms. Local algorithms are subject to the possibility of finding a result that is not the best result over all possible parameter choices. Because local algorithms do not guarantee convergence to the globally best fit, when fitting PK models, restarting the fit with different initial conditions multiple times is a good practice. Alternatively, `sbiofit` supports several global methods, such as particle swarm, or genetic algorithm optimization. Verifying that a fit is of sufficient quality is an important step before drawing inferences from the values of the parameters.

This example uses data that was the mean time course of several patients. When fitting a model with data from more patients, some parameters might be the same between patients, some not. Such requirements introduce the need for hierarchical modeling. You can perform hierarchical modeling can by configuring the `CategoryVariableName` flag of `EstimatedInfo` object.

References

- 1 Roila, Fausto, and Albano Del Favero. "Ondansetron clinical pharmacokinetics." *Clinical Pharmacokinetics* 29.2 (1995): 95-109.
- 2 Colthup, P. V., and J. L. Palmer. "The determination in plasma and pharmacokinetics of ondansetron." *European Journal of Cancer & Clinical Oncology* 25 (1988): S71-4.

See Also

`sbiofit`

More About

- "Fit One-Compartment Model to Individual PK Profile" on page 4-52
- "Fit a Two-Compartment Model to PK Profiles of Multiple Individuals" on page 4-71
- "Nonlinear Regression" on page 4-35

Accelerating Model Simulations and Analyses

In this section...

“What Is Acceleration?” on page 4-85

“When to Accelerate” on page 4-85

“Prerequisites for Accelerating Simulations and Analyses” on page 4-85

“Accelerate Simulations Programmatically” on page 4-86

“Accelerate Simulations using SimBiology Model Analyzer” on page 4-87

“Troubleshooting Accelerated Simulations” on page 4-87

What Is Acceleration?

Normally, when simulating or analyzing a model in SimBiology, the model is expressed in MATLAB code. You can accelerate the simulation by converting the model to compiled C code, which executes faster. Because this compilation step has a small time overhead, acceleration is not recommended for individual simulations of small models. However, for large models, or for repeated simulations during analysis, acceleration can provide a significant speed increase that outweighs the small time overhead.

When to Accelerate

The functionality to accelerate simulations performs optimally under the following conditions:

- Running repeated simulations with different initial conditions
- Running very long simulations (for example, simulations that take longer than a minute to run)

Prerequisites for Accelerating Simulations and Analyses

To prepare your models for accelerated simulations, install and set up a compiler:

- 1 Install a C compiler (if one is not already installed on your system). For a current list of supported compilers, see Supported and Compatible Compilers.
- 2 Ensure that any user-defined functions in your model can be used for code generation from MATLAB, so they can convert to compiled C. For more information, see Language, Function, and Object support for C and C++ code generation (MATLAB Coder) or contact MathWorks Technical Support.

Note

- On Windows, if you have not installed another compiler, SimBiology uses the lcc-win64 compiler for model accelerations. If you have installed another supported compiler, it will be selected automatically. For better performance of the acceleration functionality, you may want to install a supported compiler other than lcc-win64, and it will be selected automatically.

Accelerate Simulations Programmatically

Use `sbioaccelerate` if you are accelerating a SimBiology model. For a `SimFunction` object and an exported model (`SimBiology.export.Model`), use the corresponding `accelerate` method.

Using `sbioaccelerate`

Follow the two-step process for acceleration.

- 1 Run `sbioaccelerate` to prepare your model for accelerated simulations. Use the same input arguments that you plan to use with `sbiosimulate` in the next step. For example:

```
sbioaccelerate(model,configset,doses);
```

For a very large model, this step may take a minute or longer to complete.

- 2 Run `sbiosimulate` with the same input arguments that you used with `sbioaccelerate`. For example:

```
simdata = sbiosimulate(model,configset,doses);
```

If you pass in an array of doses to `sbioaccelerate`, you can simulate the model using any subset of these doses and do not need to run acceleration again.

For illustrated examples, see the following.

- “Prepare a Model for Accelerated Simulation”
- “Accelerate Simulation With Array of Doses”

Using `accelerate`

A `SimFunction` object is automatically accelerated at the first function execution. Hence it is not necessary to accelerate the model before you create the object. However, manually accelerate using the `accelerate` method of the object if you want it accelerated in your deployment applications.

For exported model, see `accelerate`.

When to Rerun Acceleration

If you make any modifications to the model, such as changes to reactions or adding events, you need to rerun the acceleration, before running simulations.

However, there are exceptions. You do *not* need to accelerate again if you are making the changes to:

- Any variants
- `InitialAmount` property of species
- `Capacity` property of compartments
- `Value` property of parameters
- `StopTime` property of `configset`
- `OutputTimes` property of `SolverOptions`
- `Active`, `Amount`, and `Rate` properties of `ScheduleDose` and `RepeatDose`
- `Time` property of `ScheduleDose`
- `Interval`, `RepeatCount`, and `StartTime` properties of `RepeatDose`

- Notes, Tag, and UserData properties of any applicable objects

Accelerate Simulations using SimBiology Model Analyzer

You can enable the model acceleration in the **SimBiology Model Analyzer** app by checking the **Prepare the model for accelerated simulation** box in the **Model** step of the program.

Troubleshooting Accelerated Simulations

If you have custom functions, use persistent variables only for those (constant) variables that you do not want to recalculate or reload every function call. The reason is that during the acceleration process, SimBiology converts the model and custom functions to compiled C code. If you try to use a persistent variable to share data across generated (or compiled) C functions, you may have different results. For instance, if you use a persistent variable to count how many times a function is called, each compiled function will have a separate count. Those persistent variables in the corresponding compiled functions will be different from the one used in the MATLAB function that you defined.

If you specify custom functions in SimBiology expressions, you might see the following warning if your code is not compatible with code generation from MATLAB:

```
The SimBiology Expression and any user-defined functions
could not be accelerated. Please check that these expressions
and any user-defined functions are supported for code generation
as described in the Code Generation from MATLAB documentation.
```

where *Expression* is any of the following:

- Reaction rate/rule expression
- Initial assignment rule expression
- Repeated assignment rule expression
- Event trigger expression
- Event function expression

For more information, see Language, Function, and Object support for C and C++ code generation (MATLAB Coder) or contact MathWorks Technical Support.

See Also

`sbioaccelerate` | `SimFunction` object | `SimBiology.export.Model` | `accelerate` | `accelerate`

More About

- “SimBiology Apps”
- “Model Simulation” on page 4-3
- “Troubleshooting Simulation Problems” on page 3-15

Noncompartmental Analysis

Noncompartmental analysis (NCA) lets you compute pharmacokinetic (PK) parameters of a drug from the time course of measured drug concentrations. This approach does not require the assumption of a specific compartmental model. NCA is often used to determine the degree of exposure following administration of a drug, such as AUC, and other PK parameters, such as the clearance and the terminal half-life.

Data

SimBiology lets you calculate NCA parameters from concentration-time data. The data must contain a time column, a concentration column, and a dose column that defines dose amounts. Three types of drug administration routes are supported: IV bolus, IV infusion, and Extravascular. You can have a column for each type. For infusion doses, an infusion rate column is also needed.

If you have data containing multiple groups of observations, you can define a group column. If needed, you can use two levels of hierarchy to specify grouping. Specify the outer level of grouping using the group column, and specify the inner level (subgroups) in the ID column. Consider data that contains three groups, where each group contains four patients. The group column labels the three groups, and the ID column labels each patient.

Dosing

Single-dosing data contains a single dose amount for each individual. Multiple-dosing data has several doses at different times for each individual. There are common parameters calculated for either type of dosing data, and parameters that are specific to single or multiple dosing.

Common Parameters for Single and Multiple Dosing

SimBiology computes some common parameters for single- or multiple-dosing data. This figure represents the concentration-time profile after a single dose. For multiple dosing, the same principles apply, except that SimBiology uses a steady state dosing period.

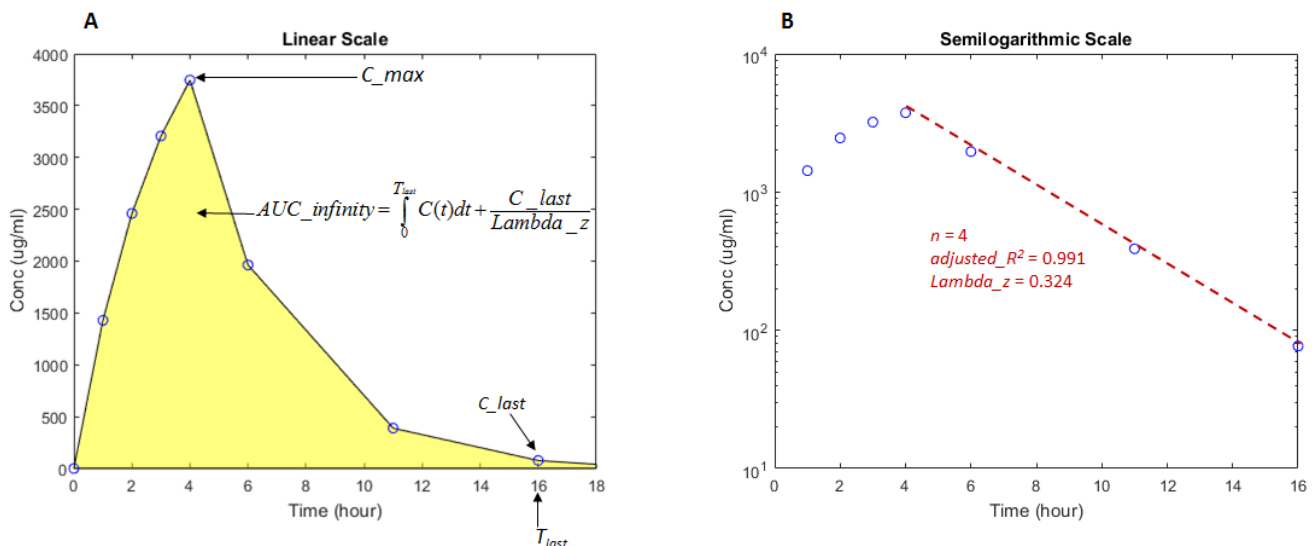

Figure **A** shows concentration–time data in a linear scale and illustrates how the AUC from time 0 to infinity is calculated. Figure **B** shows the same data in a semilogarithmic scale. To compute the terminal rate constant (λ_z), SimBiology performs a set of linear regressions of the log-transformed data using each of the last n points ($n = 3, 4, 5, \dots$) from the terminal portion of the curve. λ_z is chosen from the regression that uses the most points and has the maximum $adjusted_R^2$.

This table describes the common parameters for single and multiple dosing.

Parameter	Description
AUC_{0_last}	<p>Area under the measured concentration–time curve from time = 0 to the last time point.</p> $AUC_{0_last} = \int_0^{T_{last}} C(t)dt,$ <p>where $C(t)$ is the plasma concentration at time t.</p> <p>SimBiology uses the linear trapezoidal method to calculate the AUC.</p>
$AUC_{infinite}$	<p>Total area under the concentration–time curve extrapolating to Inf using the terminal rate constant λ_z.</p> $AUC_{infinite} = AUC_{0_last} + \frac{C_{last}}{\lambda_z},$ <p>where C_{last} is the last observed concentration and λ_z is the terminal rate constant.</p>
$AUC_{infinite_dose}$	$AUC_{infinite_dose} = \frac{AUC_{infinite}}{DM}.$
AUC_{x_y}	Partial AUC computed for a custom time range, where x and y are the start and end times, respectively.
$AUC_{extrap_percent}$	<p>Fraction of total $AUC_{infinite}$ obtained from extrapolation.</p> $AUC_{extrap_percent} = \frac{AUC_{infinite} - AUC_{0_last}}{AUC_{infinite}} * 100.$
λ_z	<p>To calculate the terminal rate constant (λ_z), SimBiology performs a set of linear regressions of the log(concentration)–time data using each of the last n points ($n = 3, 4, 5, \dots$) from the terminal portion of the curve, that is, points satisfying the conditions: $(Time \geq T_{max}) \& (Conc \leq C_{max})$. A minimum of three points is required to determine λ_z.</p> <p>λ_z is chosen from the regression that uses the most points and has the maximum $adjusted_R^2$ among all regressions.</p> $adjusted_R^2 = 1 - \frac{(1 - R^2) * (n - 1)}{n - 2}$
R^2	Coefficient of determination for the linear regressions used in the λ_z calculation.
Num_points	Number of data points from the profile used in the determination of λ_z .

Parameter	Description
C_0	Extrapolated concentration at time = 0, computed using a regression of the first two data points in a profile. This parameter is for IV Bolus doses only.
C_{max}	Maximum observed concentration.
C_{max_Dose}	$C_{max_Dose} = \frac{C_{max}}{DM}$.
$C_{max_x_y}$	Maximum observed concentration within a given time range, specified by the start time x and the end time y . This parameter is computed when you specify a custom time range in the Cmax Time Range box in the SimBiology Model Analyzer app or set the C_{max_ranges} property of the options object created by <code>sbioncaoptions</code> .
T_{last}	Time of the last observed concentration value above the lower limit of quantization (LOQ).
T_{half}	Terminal half-life of the drug. $T_{half} = \frac{\ln(2)}{\lambda_z}$
T_{max}	T_{max} is the time point at which the maximum concentration (C_{max}) is observed.
$T_{max_x_y}$	Time point at which maximum concentration is observed within a given time range, specified by the start time x and the end time y . This parameter is computed when you specify a custom time range in the Cmax Time Range box in the SimBiology Model Analyzer or set the C_{max_ranges} property of the options object created by <code>sbioncaoptions</code> .
V_{ss}	Apparent volume of distribution at equilibrium. This parameter is for IV Bolus doses only. $V_{ss} = MRT * CL$
V_z	Volume of distribution during the terminal phase. $V_z = \frac{DM}{AUC_{infinity} * \lambda_z}$
DM	Administered dose amount. For multiple dosing, the last administered dose is reported.
<code>doseSchedule</code>	Single- or multiple-dosing data.
<code>administrationRoute</code>	Dose administration route. Supported routes are IVBolus, IVInfusion, ExtraVascular.

Parameters for Single Dosing

In addition to the common parameters, SimBiology reports parameters for single-dosing data.

Parameter	Description
$AUMC_{0_last}$	Area under the first moment of the concentration-time curve from time 0 to the last time point T_{last} . $AUMC_{0_last} = \int_0^{T_{last}} t * C(t) dt.$

Parameter	Description
<i>AUMC</i>	Total area under the first moment of the concentration-time curve extrapolating to <i>Inf</i> using <i>Lambda_z</i> . $AUMC = AUMC_{0_last} + \frac{C_{last}}{\Lambda_z^2} + \frac{T_{last} * C_{last}}{\Lambda_z}$
<i>AUMC_extrap_percent</i>	Fraction of total <i>AUMC</i> obtained from extrapolation. $AUMC_extrap_percent = \frac{AUMC - AUMC_{0_last}}{AUMC} * 100.$
<i>CL</i>	Total drug clearance. $CL = \frac{DM}{AUC_infinity}$ <p>where <i>DM</i> is the dose amount.</p>
<i>MRT</i>	Mean residence time. $MRT = \frac{AUMC}{AUC_infinity}$

Parameters for Multiple Dosing

This figure shows the concentration-time profile after multiple doses. SimBiology uses a steady state dosing period to compute the following NCA parameters for multiple-dosing data, in addition to the common parameters listed previously. In the following figure, the last dosing period is used for illustration purposes.

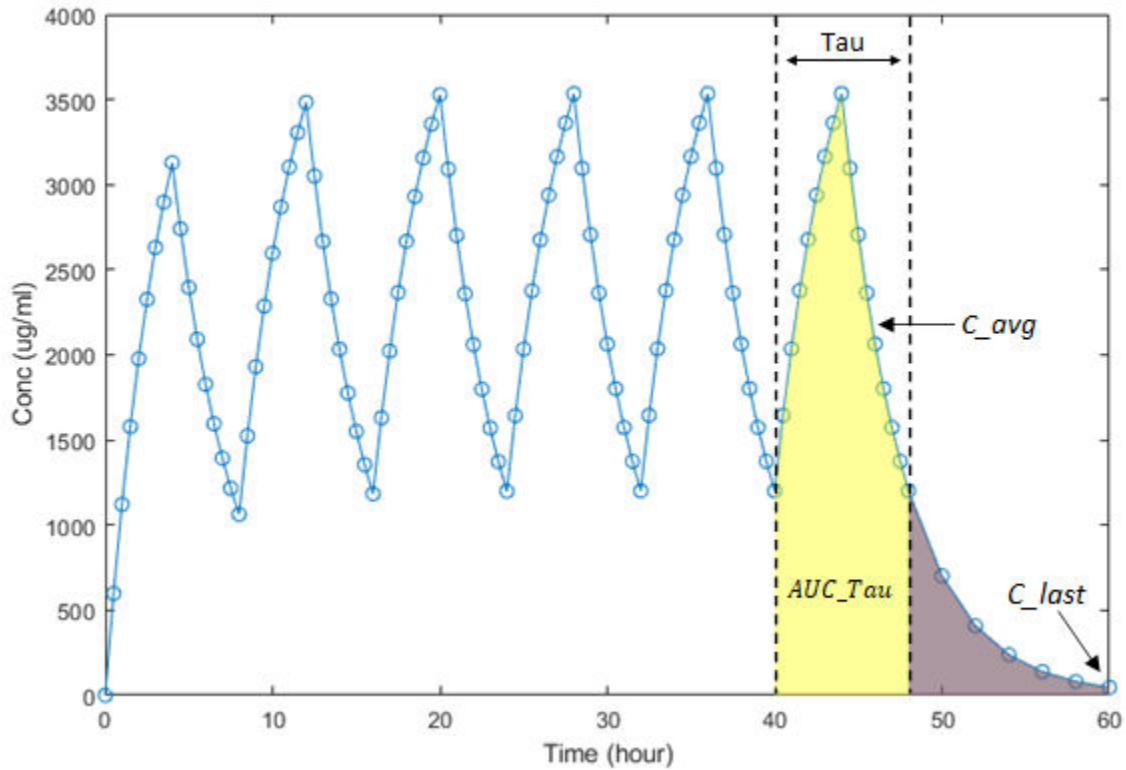

Parameter	Description
AUC_Tau	Area under the concentration-time curve during a dosing period of length Tau . SimBiology uses a steady-state dosing period (SS_period). $AUC_Tau = \int_{SS_period}^{SS_period + Tau} C(t)dt.$
Tau	Dosing interval.
$AUMC_Tau$	Area under the first moment of the concentration-time curve during a steady-state dosing period of length Tau . $AUMC_Tau = \int_{SS_period}^{SS_period + Tau} t * C(t)dt.$
C_avg	Average concentration over one period. $C_avg = \frac{AUC_Tau}{Tau}.$
C_min	Minimum observed concentration during the first period, that is, $C_min = C(T_min)$.
$PTF_percent$	Peak trough fluctuation over one dosing interval at steady state. $PTF_Percent = \frac{C_max - C_min}{C_Avg} * 100.$

Parameter	Description
<i>Accumulation_Index</i>	Theoretical accumulation ratio. $Accumulation_Index = \frac{1}{1 - e^{-\lambda_z \cdot \tau}}$
<i>T_min</i>	Time at which the minimum concentration is reached in a dosing interval.
<i>MRT</i>	Mean residence time. $MRT = \frac{AUMC_Tau + \tau \cdot (AUC_infinity - AUC_0_last)}{AUC_Tau}$ Note that for drugs with prolonged half-lives, the extrapolation necessary to compute the term <i>AUC_infinity - AUC_0_last</i> can lead to approximation errors.
<i>CL</i>	Total drug clearance. $CL = \frac{DM}{AUC_Tau}$ Here, <i>DM</i> is the dose amount.

Sparse Sampling

To calculate PK parameters, measured concentrations at multiple time points for each individual is needed after the drug administration. Under certain circumstances, it is not feasible or not practical to obtain such longitudinal data on a single subject. In such cases, concentration data is collected from multiple individuals at each time point and then averaged to calculate NCA parameters for each group instead. SimBiology performs such sparse sampling by taking the average of the dependent variable for all individuals at the same time point. It then returns the values of NCA parameters for each group. Time values for each measurement across individuals (IDs) within a group must be identical.

Calculating NCA Parameters

You can calculate NCA parameters using the `sbionca` function in the command line or using the **SimBiology Model Analyzer** app.

Using `sbionca`

`sbionca` provides command line functionality to compute NCA parameters. Define the data classification options and parameter calculation options using an option object created by `sbioncaoptions`. For an example, see “Compute NCA Parameters from Concentration-Time Data”.

Using SimBiology Model Analyzer

After you import the data, select **Program > Non-Compartmental Analysis** on the **Home** tab. You can classify your data column in the **NCA** step of the program. If your data has a grouping column, specify it using **Group**. Use **ID** to specify the inner level of grouping. Specify the dosing data column (**IV Bolus Dose** or **Extravascular Dose**). **Lower limit of quantization (LOQ)** is a threshold below which the values of dependent variables are truncated to zero.

Lambda Time Range lets you specify a custom time range to compute the terminal rate constant (λ_z). The time range applies to all groups; you cannot specify a different time range for each group.

Cmax Time Range lets you specify a custom time range to report the maximum observed concentration within the range (C_{max}) and the time (T_{max}) when it is observed. You can specify a different time range for each group.

Partial AUC lets you specify a custom time range to compute the partial AUC bounded by the start and end times. You can specify a different time range for each group.

You can export the NCA results to MATLAB workspace. By default, the data is exported as a table. To convert it to a dataset, use `table2dataset`.

For a workflow example, see “Calculate NCA Parameters and Fit Model to PK/PD Data Using SimBiology Model Analyzer App” on page 1-77.

See Also

`sbioncaoptions` | `sbionca`

More About

- “SimBiology Apps”

Stochastic Simulation of Radioactive Decay

This example shows how to build and simulate a model using the SSA stochastic solver.

The following model will be constructed and stochastically simulated:

- Reaction 1: $x \rightarrow z$ with a first-order reaction rate, $c = 0.5$.
- Initial conditions: $x = 1000$ molecules, $z = 0$.

This model can also be used to represent irreversible isomerization.

This example uses parameters and conditions as described in Daniel T. Gillespie, 1977, "Exact Stochastic Simulation of Coupled Chemical Reactions," The Journal of Physical Chemistry, vol. 81, no. 25, pp. 2340-2361.

Read the Radioactive Decay Model Saved in SBML Format

SBML = Systems Biology Markup Language, www.sbml.org

```
model = sbmlimport('radiodecay.xml')

model =
  SimBiology Model - RadioactiveDecay

  Model Components:
    Compartments:      1
    Events:            0
    Parameters:        1
    Reactions:         1
    Rules:             0
    Species:           2
    Observables:      0
```

View Species Objects of the Model

```
model.Species

ans =
  SimBiology Species Array

  Index:  Compartment:  Name:  Value:  Units:
  1      unnamed      x    1000  molecule
  2      unnamed      z     0    molecule
```

View Reaction Objects of the Model

```
model.Reactions

ans =
  SimBiology Reaction Array

  Index:  Reaction:
  1      x -> z
```

View Parameter Objects for the Kinetic Law

```
model.Reactions(1).KineticLaw(1).Parameters
```

```
ans =  
  SimBiology Parameter Array  
  
  Index:   Name:   Value:   Units:  
  1       c       0.5     1/second
```

Update the Reaction to use MassAction Kinetic Law for Stochastic Solvers.

```
model.Reactions(1).KineticLaw(1).KineticLawName = 'MassAction';  
model.Reactions(1).KineticLaw(1).ParameterVariableNames = {'c'};
```

Simulate the Model Using the Stochastic (SSA) Solver & Plot

```
cs = getconfigset(model, 'active');  
cs.SolverType = 'ssa';  
cs.StopTime = 14.0;  
cs.CompileOptions.DimensionalAnalysis = false;  
[t,X] = sbiosimulate(model);  
  
plot(t,X);  
legend('x', 'z', 'AutoUpdate', 'off');  
title('Stochastic Radioactive Decay Simulation');  
ylabel('Number of molecules');  
xlabel('Time (seconds)');
```

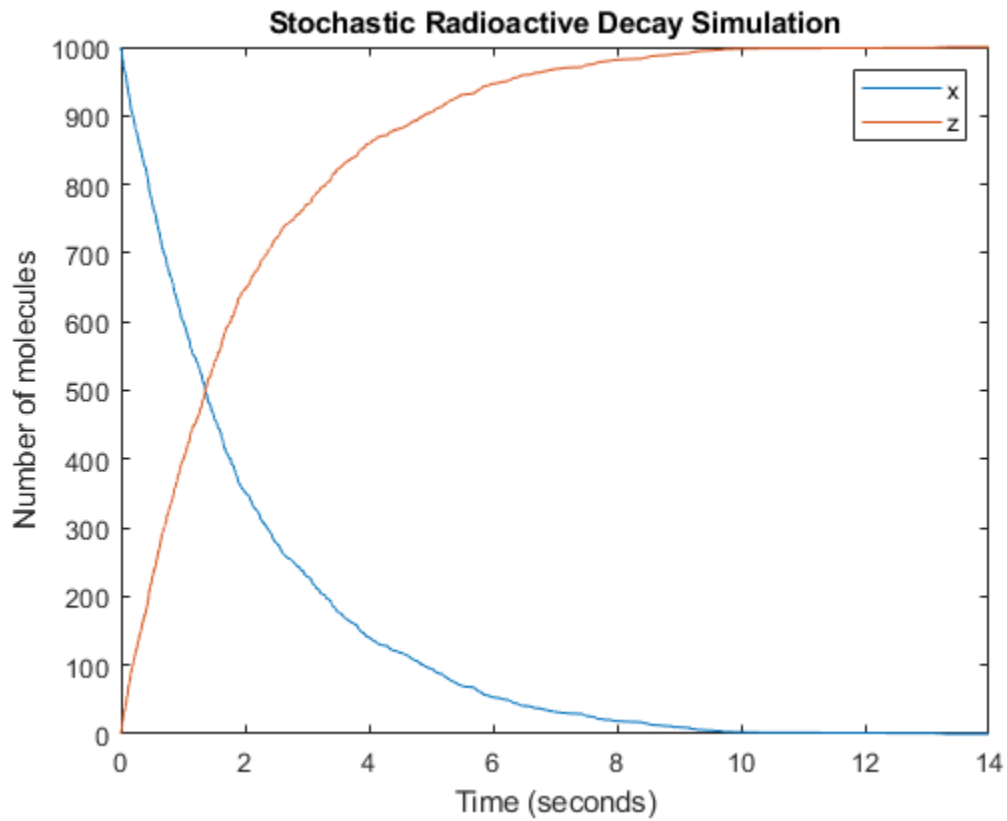

Repeat the Simulation to Show Run-to-Run Variability

```
title('Multiple Stochastic Radioactive Decay Simulations');  
hold on;  
for loop = 1:20  
    [t,X] = sbiosimulate(model);  
    plot(t,X);    % Just plot number of reactant molecules  
    drawnow;  
end
```

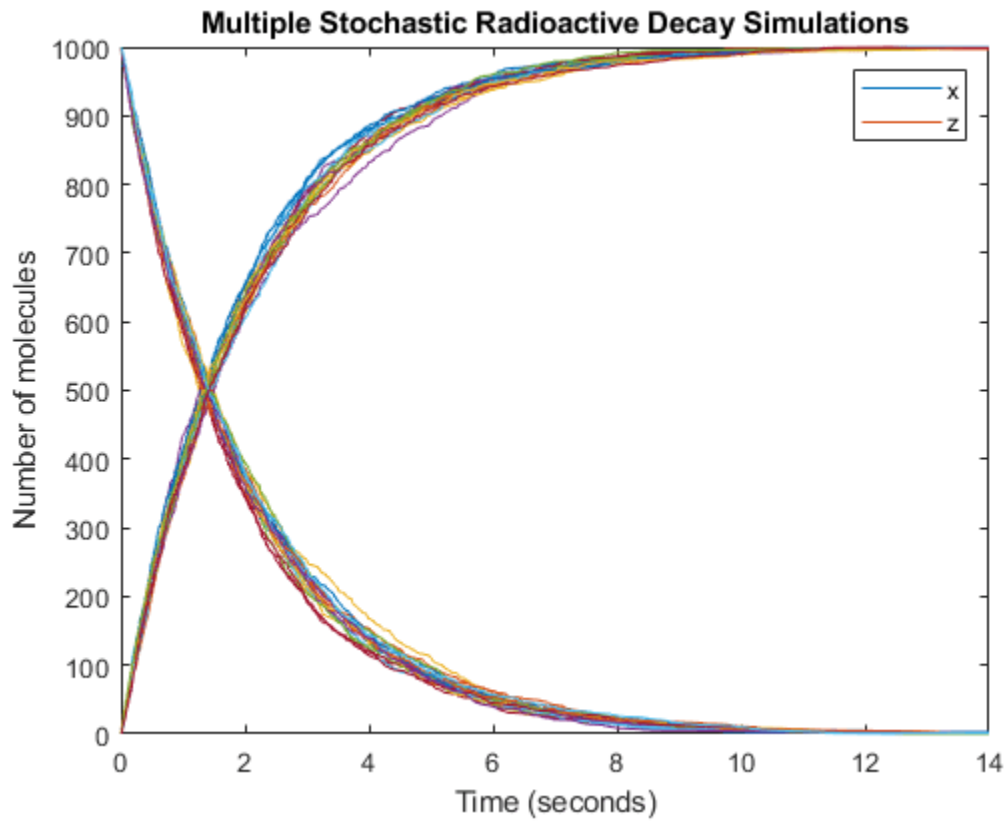
**Overlay the Reaction's ODE Solution in Red**

```
cs = getconfigset(model, 'active');  
cs.SolverType = 'sundials';  
cs.StopTime = 20;  
[t,X] = sbiosimulate(model);  
plot(t,X, 'red');  
hold off;
```

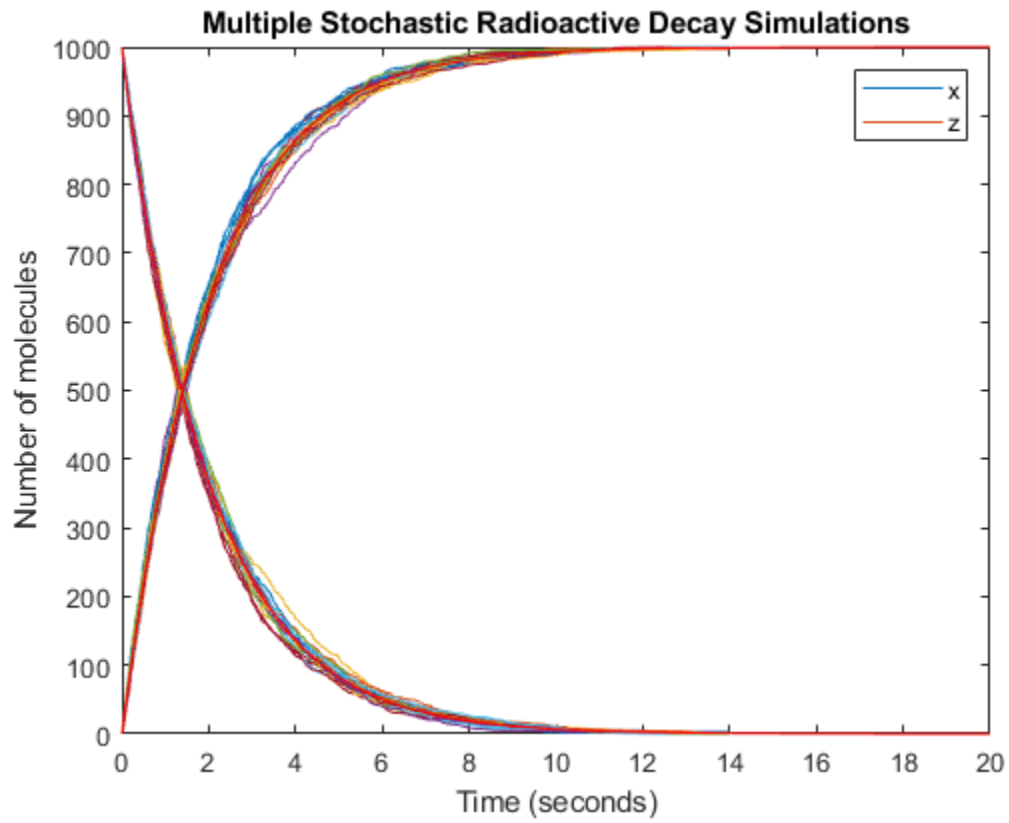

Stochastic Simulation of the Lotka-Volterra Reactions

This example shows how to build and simulate a model using the SSA stochastic solver.

The following model will be constructed and stochastically simulated:

- Reaction 1: $x + y_1 \rightarrow 2 y_1 + x$, with rate constant, $c_1 = 10$.
- Reaction 2: $y_1 + y_2 \rightarrow 2 y_2$, with rate constant, $c_2 = 0.01$.
- Reaction 3: $y_2 \rightarrow z$, with rate constant, $c_3 = 10$.
- Initial conditions: $x=1$ (constant), $y_1=y_2=1000$, $z=0$.
- Note: Species 'x' in Reaction 1 is represented on both sides of the reaction to model the assumption that the amount of x is constant.

These reactions can be interpreted as a simple predator-prey model if one considers that the prey population (y_1) increases in the presence of food (x) (Reaction 1), that the predator population (y_2) increases as they eat prey (Reaction 2), and that predators (y_2) die of natural causes (Reaction 3).

This example uses parameters and conditions as described in Daniel T. Gillespie, 1977, "Exact Stochastic Simulation of Coupled Chemical Reactions," The Journal of Physical Chemistry, vol. 81, no. 25, pp. 2340-2361.

Register Units for the Model

```
sbioaddtolibrary(sbiounit('rabbit','molecule',1));
sbioaddtolibrary(sbiounit('coyote','molecule',1));
sbioaddtolibrary(sbiounit('food','molecule',1));
sbioaddtolibrary(sbiounit('amountDimension','molecule',1));
```

Create the Lotka-Volterra Model

```
model = sbiomodel('Lotka-Volterra Model');
c = addcompartment(model,'C');
c.CapacityUnits = 'meter^3';
```

Add Reaction 1 to the Model Object

```
r1 = addreaction(model,'x + y1 -> 2 y1 + x')
```

```
r1 =
  SimBiology Reaction Array

  Index:   Reaction:
  1        x + y1 -> 2 y1 + x
```

```
% Set the Kinetic Law for Reaction 1.
kl1 = addkineticlaw(r1, 'MassAction');
```

```
% Add rate constant parameter, c1, to reaction with value = 10
p1 = addparameter(kl1, 'c1', 'Value', 10);
```

```
kl1.ParameterVariableNames = {'c1'};
```

```
% Add units to c1
p1.ValueUnits = '1/(second*rabbit)';
```



```

% Set initial amounts for species in Reaction 1
r1.Reactants(1).InitialAmount = 1;           % x
r1.Reactants(2).InitialAmount = 1000;       % y1

% Set the initial amount units for species in Reaction 1
r1.Reactants(1).InitialAmountUnits = 'food'; % x
r1.Reactants(2).InitialAmountUnits = 'rabbit'; % y1

```

Add Reaction 2 to the Model Object

```
r2 = addreaction(model, 'y1 + y2 -> 2 y2')
```

```
r2 =
  SimBiology Reaction Array
```

```

Index:   Reaction:
1        y1 + y2 -> 2 y2

```

```

% Set the kinetic law for Reaction 2.
kl2 = addkineticlaw(r2, 'MassAction');

```

```

% Add rate constant parameter, c2, to kinetic law with value = 0.01
p2 = addparameter(kl2, 'c2', 'Value', 0.01);

```

```
kl2.ParameterVariableNames = {'c2'};
```

```

% Add units to c2
p2.ValueUnits = '1/(second*coyote)';

```

```

% Set initial amounts for new species in Reaction 2
r2.Products(1).InitialAmount = 1000;         % y2
% Set the initial amount units for new species in Reaction 2
r2.Products(1).InitialAmountUnits = 'coyote'; % y2

```

Add Reaction 3 to the Model Object

```
r3 = addreaction(model, 'y2 -> z')
```

```
r3 =
  SimBiology Reaction Array
```

```

Index:   Reaction:
1        y2 -> z

```

```

% Add "bogus" units to trash variable 'z'
r3.Products(1).InitialAmountUnits = 'amountDimension';

```

```

% Set the kinetic law for Reaction 3.
kl3 = addkineticlaw(r3, 'MassAction');

```

```

% Add rate constant parameter, c3, to reaction with value = 10
p3 = addparameter(kl3, 'c3', 'Value', 10);

```

```
kl3.ParameterVariableNames = {'c3'};
```

```
% Add units to c3
p3.ValueUnits = '1/second';
```

Display the Completed Model Objects

```
model

model =
  SimBiology Model - Lotka-Volterra Model

  Model Components:
    Compartments:      1
    Events:            0
    Parameters:        3
    Reactions:         3
    Rules:             0
    Species:           4
    Observables:      0
```

Display the Reaction Objects

```
model.Reactions

ans =
  SimBiology Reaction Array

  Index:   Reaction:
  1       x + y1 -> 2 y1 + x
  2       y1 + y2 -> 2 y2
  3       y2 -> z
```

Display the Species Objects

```
model.Species

ans =
  SimBiology Species Array

  Index:   Compartment:   Name:   Value:   Units:
  1       C              x       1       food
  2       C              y1     1000    rabbit
  3       C              y2     1000    coyote
  4       C              z       0       amountDimension
```

Simulate with the Stochastic (SSA) Solver & Plot

```
cs = getconfigset(model, 'active');
cs.SolverType = 'ssa';
cs.StopTime = 30;
cs.SolverOptions.LogDecimation = 200;
cs.CompileOptions.UnitConversion = true;
[t,X] = sbiosimulate(model);

plot(t, X(:,2), t, X(:,3));
legend('Y1', 'Y2');
title('Lotka-Volterra Reaction - State History');
```

```
ylabel('Number of predator-prey');  
grid on;
```

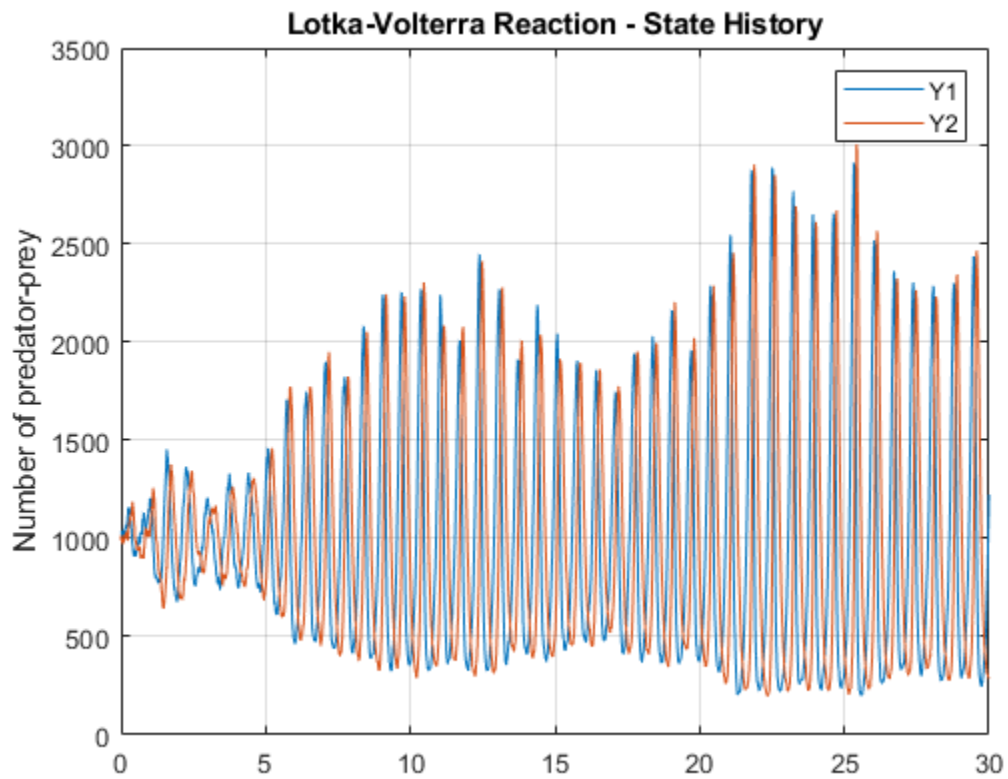

Show Phase Portrait of Y1 to Y2

```
plot(X(:,2),X(:,3));  
title('Lotka-Volterra Reaction - Y1 vs. Y2');  
xlabel('Number of Y1 rabbits');  
ylabel('Number of Y2 coyotes');
```

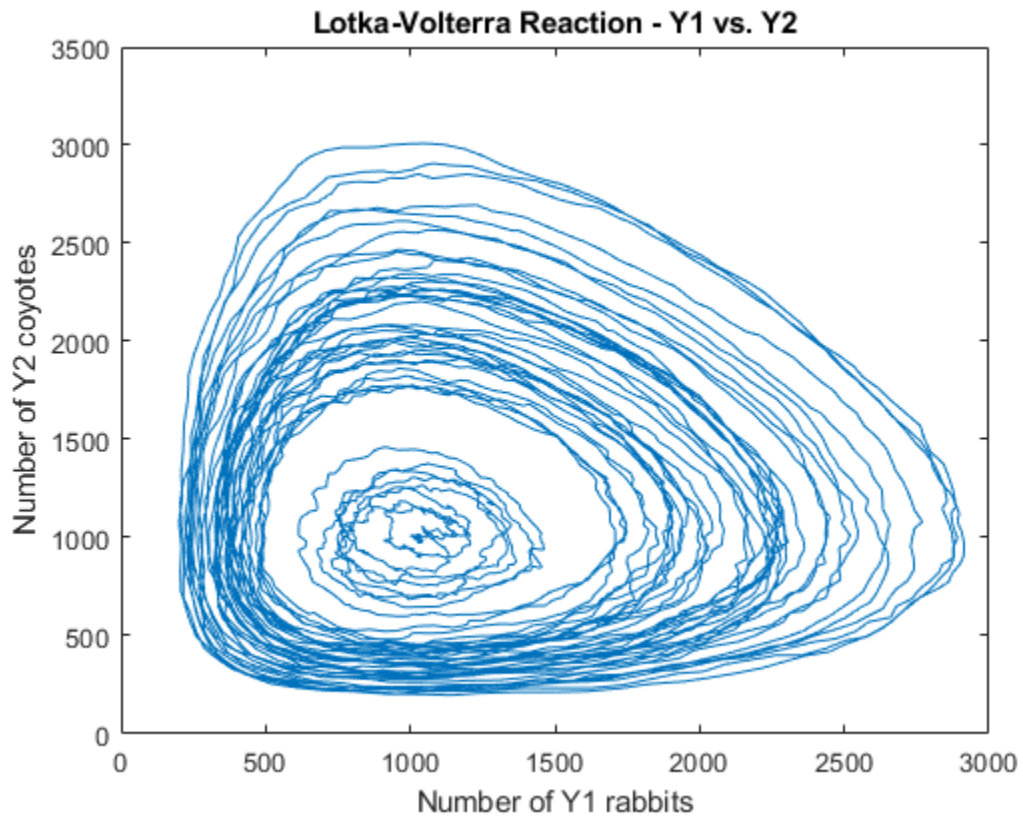

```
% Clean up units.  
sbioremovefromlibrary('unit', 'rabbit');  
sbioremovefromlibrary('unit', 'coyote');  
sbioremovefromlibrary('unit', 'food');  
sbioremovefromlibrary('unit', 'amountDimension');
```

Comparing SSA and Explicit Tau-Leaping Stochastic Solvers

This example shows how to build and simulate a model using the SSA stochastic solver and the Explicit Tau-Leaping solver.

The following decaying-dimerizing reactions will be constructed and stochastically simulated:

- Reaction 1: $s_1 \rightarrow \text{null}$, with reaction rate constant, $c_1 = 1.0$
- Reaction 2: $2 s_1 \leftrightarrow s_2$, with reaction rate constants, forward: $c_{2f} = 0.002$ reverse: $c_{2r} = 0.5$
- Reaction 3: $s_2 \rightarrow s_3$, with reaction rate constant, $c_3 = 0.04$
- Initial conditions: $s_1 = 100000$ molecules, $s_2 = s_3 = 0$

This example uses parameters and conditions as described in Daniel T. Gillespie, 2001, "Approximate accelerated stochastic simulation of chemically reacting systems," Journal of Chemical Physics, vol. 115, no. 4, pp. 1716-1733.

Create Decaying-Dimerizing Model

```
model = sbiomodel('Decaying-Dimerizing Reaction Set');
```

Enter Reactions

```
r1 = addreaction(model, 's1 -> null');
r2 = addreaction(model, '2 s1 <-> s2');
r3 = addreaction(model, 's2 -> s3');
```

Set Reactions to be MassAction

```
kl1 = addkineticlaw(r1, 'MassAction');
kl2 = addkineticlaw(r2, 'MassAction');
kl3 = addkineticlaw(r3, 'MassAction');
```

Add Rate Constants for Each Reaction

```
p1 = addparameter(kl1, 'c1', 'Value', 1.0);
p2f = addparameter(kl2, 'c2f', 'Value', 0.002);
p2r = addparameter(kl2, 'c2r', 'Value', 0.5);
p3 = addparameter(kl3, 'c3', 'Value', 0.04);
```

Set the Kinetic Law Constants for Each Kinetic Law.

```
kl1.ParameterVariableNames = {'c1'};
kl2.ParameterVariableNames = {'c2f', 'c2r'};
kl3.ParameterVariableNames = {'c3'};
```

Specify Initial Amounts of Each Species

```
model.species(1).InitialAmount = 100000;    % s1
model.species(2).InitialAmount = 0;        % s2
model.species(3).InitialAmount = 0;        % s3
```

Display the Completed Model Objects

```
model
model =
  SimBiology Model - Decaying-Dimerizing Reaction Set
```

```
Model Components:
  Compartments:    1
  Events:          0
  Parameters:      4
  Reactions:       3
  Rules:           0
  Species:         3
  Observables:    0
```

Display the Reaction Objects

```
model.Reactions
```

```
ans =
  SimBiology Reaction Array

  Index:    Reaction:
  1         s1 -> null
  2         2 s1 <-> s2
  3         s2 -> s3
```

Display the Species Objects

```
model.Species
```

```
ans =
  SimBiology Species Array

  Index:    Compartment:    Name:    Value:    Units:
  1         unnamed        s1      100000
  2         unnamed        s2      0
  3         unnamed        s3      0
```

Get the Active Configuration Set for the Model.

```
cs = getconfigset(model, 'active');
```

Simulate Model Using SSA Stochastic Solver and Plot

```
tfinal = 30, logging every 10th datapoint.
```

```
cs.SolverType = 'ssa';
cs.StopTime = 30;
solver = cs.SolverOptions;
solver.LogDecimation = 10;
cs.CompileOptions.DimensionalAnalysis = false;
[t_ssa, x_ssa] = sbiosimulate(model);

h1 = subplot(2,1,1);
plot(h1, t_ssa, x_ssa(:,1), '.');
h2 = subplot(2,1,2);
plot(h2, t_ssa, x_ssa(:,2:3), '.');
grid(h1, 'on');
grid(h2, 'on');
title(h1, 'Decay Dimerizing Reactions');
```

```

ylabel(h1, 'Amount of S1');
ylabel(h2, 'Amount of S2 & S3');
xlabel(h2, 'Time');
legend(h2, 'S2', 'S3');

```

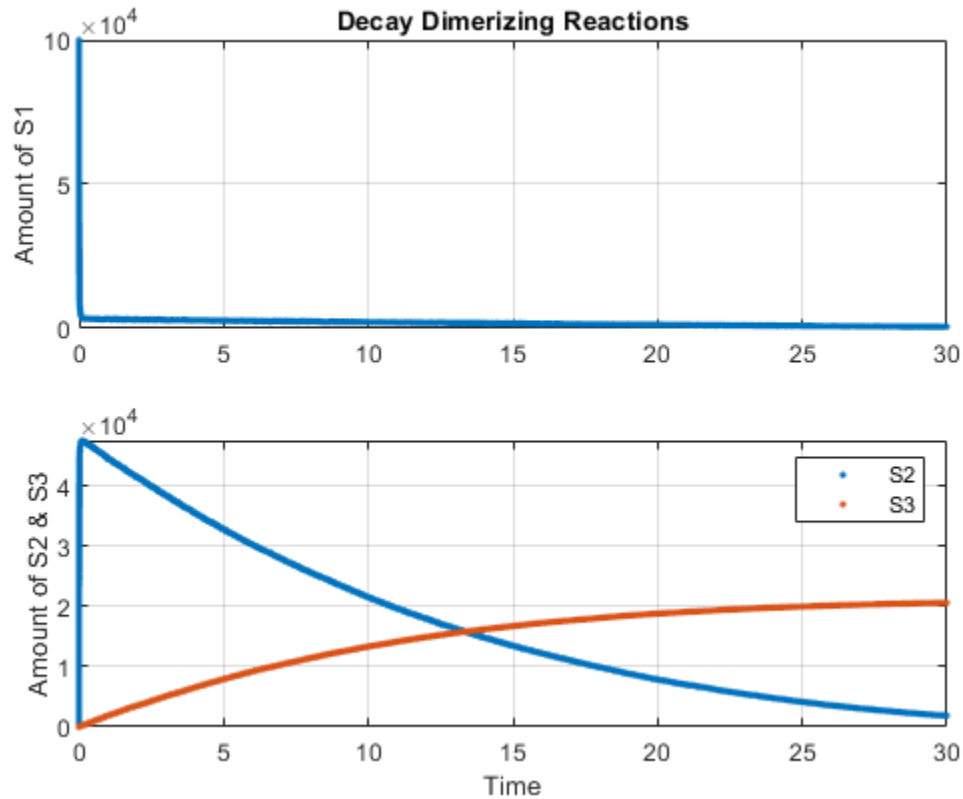

Simulate Model Using Explicit Tau-Leaping Solver and Plot in the Same Figure

Without closing the figure window, plot the results from using the Explicit Tau-Leaping Solver.

tfinal = 30, logging every 10th datapoint. Acceptable error tolerance for solver, 0.03.

```

cs.StopTime = 30;
cs.SolverType = 'explTau';
solver = cs.SolverOptions;
solver.LogDecimation = 10;
[t_etl, x_etl] = sbiosimulate(model);

hold(h1, 'on');
hold(h2, 'on');
plot(h1, t_etl, x_etl(:,1), 'o');
plot(h2, t_etl, x_etl(:,2:3), 'o');
legend(h2, 'S2 (SSA)', 'S3 (SSA)', 'S2 (Exp. Tau)', 'S3 (Exp. Tau)');
hold(h1, 'off');
hold(h2, 'off');

```

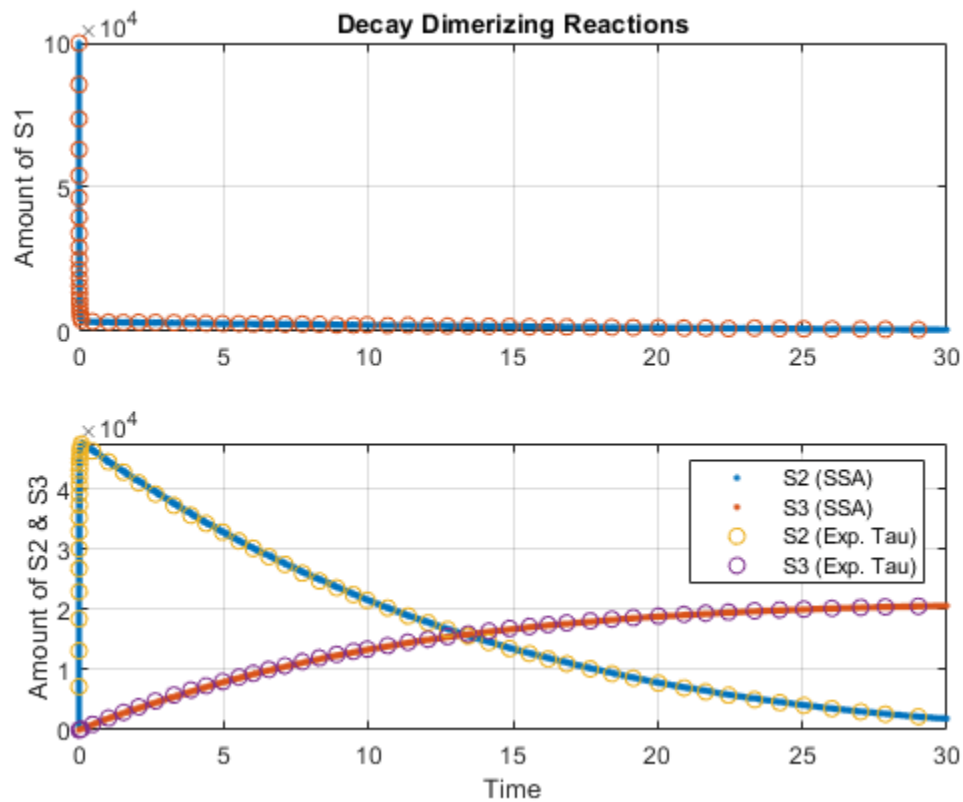

Comparison of Number of Steps for SSA and Explicit Tau-Leaping Algorithms

```
fprintf('Approximate Number of SSA steps: %d\n', (length(t_ssa) * 10));
```

```
Approximate Number of SSA steps: 616010
```

```
fprintf('Approximate Number of Explicit Tau-Leaping steps: %d\n', ...  
      (length(t_etl) * 10));
```

```
Approximate Number of Explicit Tau-Leaping steps: 620
```

Deterministic Simulation of a Model Containing a Discontinuity

This example shows how to correctly build a SimBiology® model that contains discontinuities.

Background

The model you create in this example simulates the first-order elimination of a protein that is produced at a specified rate. The production rate contains two discontinuities. To simulate the model accurately, you must create events that are triggered at the time of the discontinuity.

The production rate has three "modes" of production, as illustrated in the following plot:

```
plot([0 3 3 6 6 10], [5 5 3 3 0 0]);  
ylim([-0.5 5.5]);  
xlabel('Time');  
ylabel('Rate');  
title('Discontinuous Protein Production Rate');
```

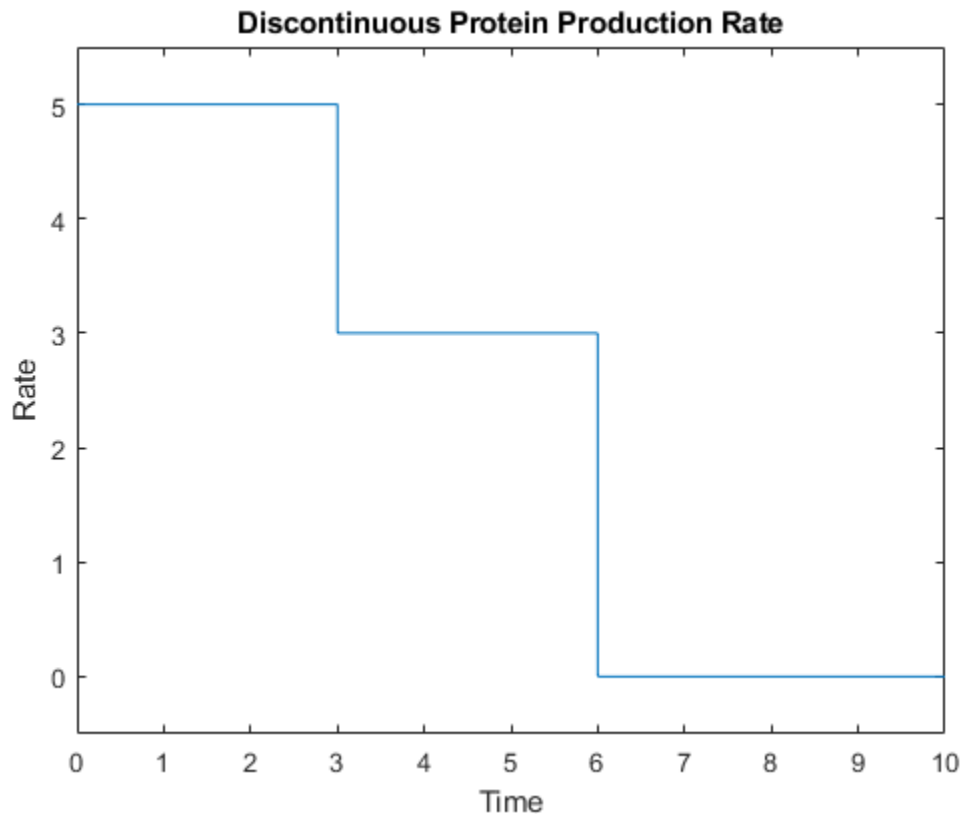

Initially ("Mode 1"), the production rate is a constant value of 5. From 3 to 6 seconds ("Mode 2"), the production rate is 3. After 6 seconds ("Mode 3"), the production rate is 0. These production rates are implemented in a MATLAB function `discontSimBiologyRateFunction.m`, which requires two arguments, simulation time and production mode.

In this example, you will add events to the model to change the mode of protein production. This approach ensures that discontinuities in the model occur only via events, which further ensures that the ODE solver accurately calculates the numerical behavior near the discontinuities.

Note that to simulate a model accurately you must use events to handle *any* discontinuity, whether related to function values or their derivatives.

Construct the Model, Compartment, and Species

```
model = sbiomodel('discontinuous rate');
central = addcompartment(model, 'Central');
addspecies(central, 'protein')

ans =
  SimBiology Species Array

  Index:    Compartment:    Name:    Value:    Units:
  1         Central        protein  0
```

Construct the Reaction for First-Order Elimination

```
reaction1 = addreaction(model, 'protein -> null')

reaction1 =
  SimBiology Reaction Array

  Index:    Reaction:
  1         protein -> null

ke = addparameter(model, 'ke', 0.5);
kineticLaw1 = addkineticlaw(reaction1, 'MassAction');
kineticLaw1.ParameterVariableNames = {ke.Name};
reaction1.ReactionRate;
```

Construct the Events That Are Triggered at the Time of Discontinuities

These events set a parameter mode that controls the mode of protein production. The mode is initially 1, changes to 2 at time 3, and changes to 3 at time 6.

```
counter = addparameter(model, 'mode', 1, 'ConstantValue', false);
addevent(model, 'time > 3', 'mode = 2')

ans =
  SimBiology Event Array

  Index:    Trigger:    EventFcns:
  1         time > 3    mode = 2

addevent(model, 'time > 6', 'mode = 3')

ans =
  SimBiology Event Array

  Index:    Trigger:    EventFcns:
  1         time > 6    mode = 3
```

Construct the Reaction for Protein Production

We assign this rate to a parameter using a repeated assignment rule. This lets us store the production rate in the simulation results.

```

reaction2 = addreaction(model, 'null -> protein');
rate2 = addparameter(model, 'rate2', 0, 'ConstantValue', false);
reaction2.ReactionRate = 'rate2'

reaction2 =
  SimBiology Reaction Array

  Index:    Reaction:
  1         null -> protein

addrule(model, 'rate2 = discountSimBiologyRateFunction(time, mode)', 'repeatedAssignment')

ans =
  SimBiology Rule Array

  Index:    RuleType:          Rule:
  1         repeatedAssignment  rate2 = discountSimBiologyRateFunction(time, mode)

```

View the Contents of discountSimBiologyRateFunction

```

type discountSimBiologyRateFunction

function rate = discountSimBiologyRateFunction(time, mode) %#ok<INUSL>
%discountSimBiologyRateFunction - Helper function for SimBiology examples.
% RATE = discountSimBiologyRateFunction(TIME, MODE);

% Copyright 2010-2021 The MathWorks, Inc.

% Mode is a double precision number subject to round-off errors. We need to
% round to the nearest integer to correctly handle this issue.
mode = round(mode);
switch mode
  case 1
    rate = 5;
  case 2
    rate = 3;
  case 3
    rate = 0;
  otherwise
    error('Invalid mode.');
```

Simulate and Plot the Model

```

model

model =
  SimBiology Model - discontinuous rate

Model Components:
  Compartments:    1
  Events:          2
  Parameters:      3
  Reactions:       2
  Rules:           1
  Species:         1

```

Observables: 0

```
sd = sbiosimulate(model);  
plot(sd.Time, sd.Data);  
ylim([-0.5 8]);  
xlabel('Time');  
ylabel('State');  
title('Simulation Results');  
legend(sd.DataNames);
```

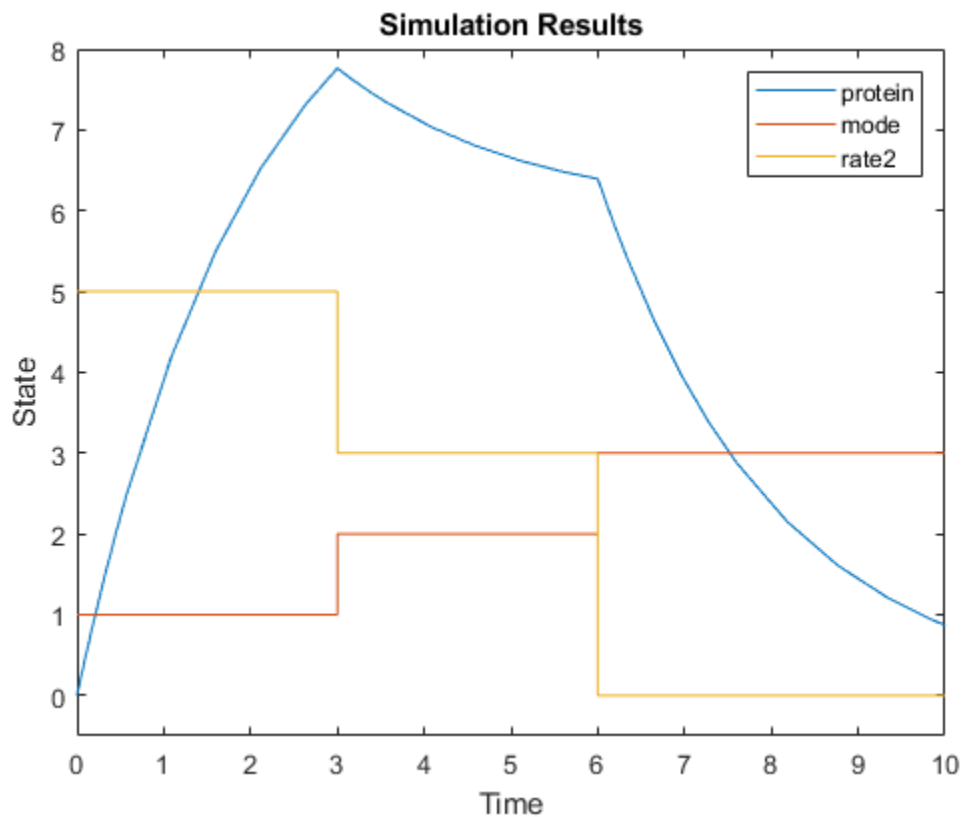

Conclusion

This example illustrates how to create a SimBiology model that contains discontinuities. It illustrates how to add events to the model to address the discontinuities, so you can simulate the model accurately.

Analysis of Stochastic Ensemble Data in SimBiology

This example shows how to make ensemble runs and how to analyze the generated data in SimBiology®.

Introduction

When the behavior of a model is stochastic in nature, a single simulation run does not provide enough insight into the model. One has to perform an ensemble of runs. Ensemble runs produce large amounts of data that require systematic analysis.

This example illustrates how to make ensemble runs using SimBiology and how to analyze the generated data.

Load Model

We will use the G Protein model that was built using published data from Yi et al. (2003). Load the wild-type G Protein model and look at its species and reactions.

```
sbioloadproject gprotein_norules m1
m1.Species
```

```
ans =
  SimBiology Species Array

  Index:    Compartment:    Name:    Value:    Units:
  1         unnamed        G        7000
  2         unnamed        Gd       3000
  3         unnamed        Ga        0
  4         unnamed        RL        0
  5         unnamed        L        6.022e+17
  6         unnamed        R        10000
  7         unnamed        Gbg      3000
```

m1.Reactions

```
ans =
  SimBiology Reaction Array

  Index:    Reaction:
  1         L + R <-> RL
  2         R <-> null
  3         RL -> null
  4         Gd + Gbg -> G
  5         G + RL -> Ga + Gbg + RL
  6         Ga -> Gd
```

Perform Ensemble Runs

Ensemble runs can be done only if you are using stochastic solvers. With deterministic solvers, it does not make sense to do ensemble runs since you will always get exactly identical results. Due to stochasticity, the sample plots on this page might not exactly match the plots you get from running this example yourself.

Change the solver type to SSA and perform 10 runs of the model. To speed up the simulation, let's log only every 100th reaction event.

```
numRuns = 10;
configsetObj = getconfigset(m1, 'active');
configsetObj.SolverType = 'ssa';
configsetObj.SolverOptions.LogDecimation = 100;
simdata = sbioensemblerun(m1, numRuns);
```

Plot of Raw Data

Plot the raw data corresponding to the species named G, Ga and RL and annotate the plot appropriately.

```
figure;
speciesNames = {'G', 'Ga', 'RL'};
[t, x] = selectbyname(simdata, speciesNames);
hold on;
for i = 1:numRuns
    plot(t{i}, x{i});
end

grid on;
xlabel('Time in seconds');
ylabel('Species amount');
title('Raw Ensemble Data');
legend(speciesNames);
```

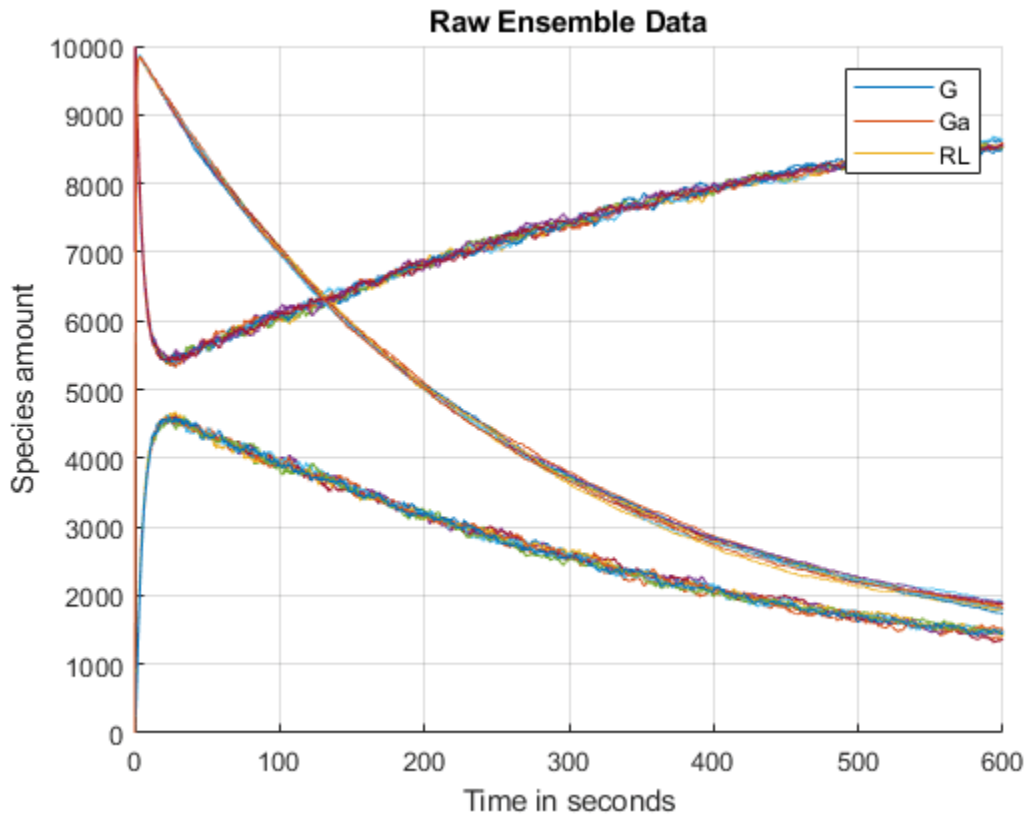

Ensemble Statistics

Let's compute ensemble statistics for these species.

```
[timeVals, meanVals, varianceVals] = sbioensemblestats(simdata, speciesNames);
```

Let's plot the mean and standard deviation as a function of time.

```
figure;
plot(timeVals, meanVals);
grid on;
xlabel('Time in seconds');
ylabel('Mean');
title('Variation of Mean');
legend(speciesNames, 'Location', 'NorthEastOutside');
```

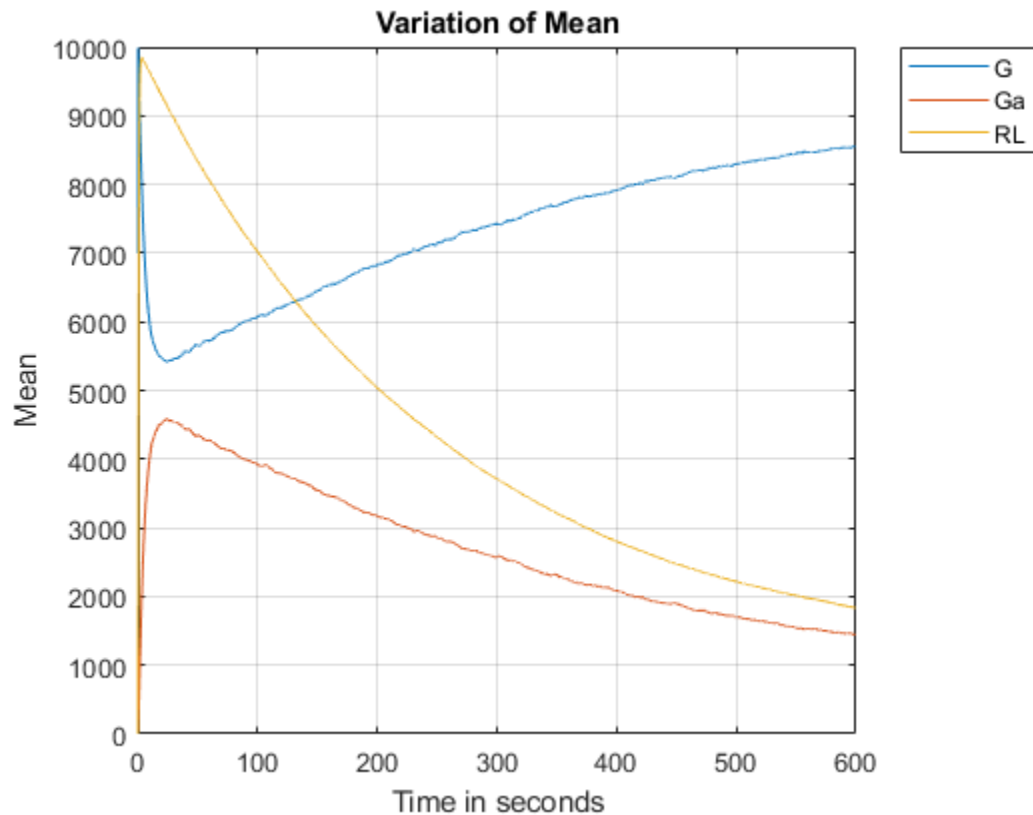

```
figure;
plot(timeVals, sqrt(varianceVals));
grid on;
xlabel('Time in seconds');
ylabel('Standard Deviation');
title('Variation of Standard Deviation');
legend(speciesNames, 'Location', 'NorthEastOutside');
```

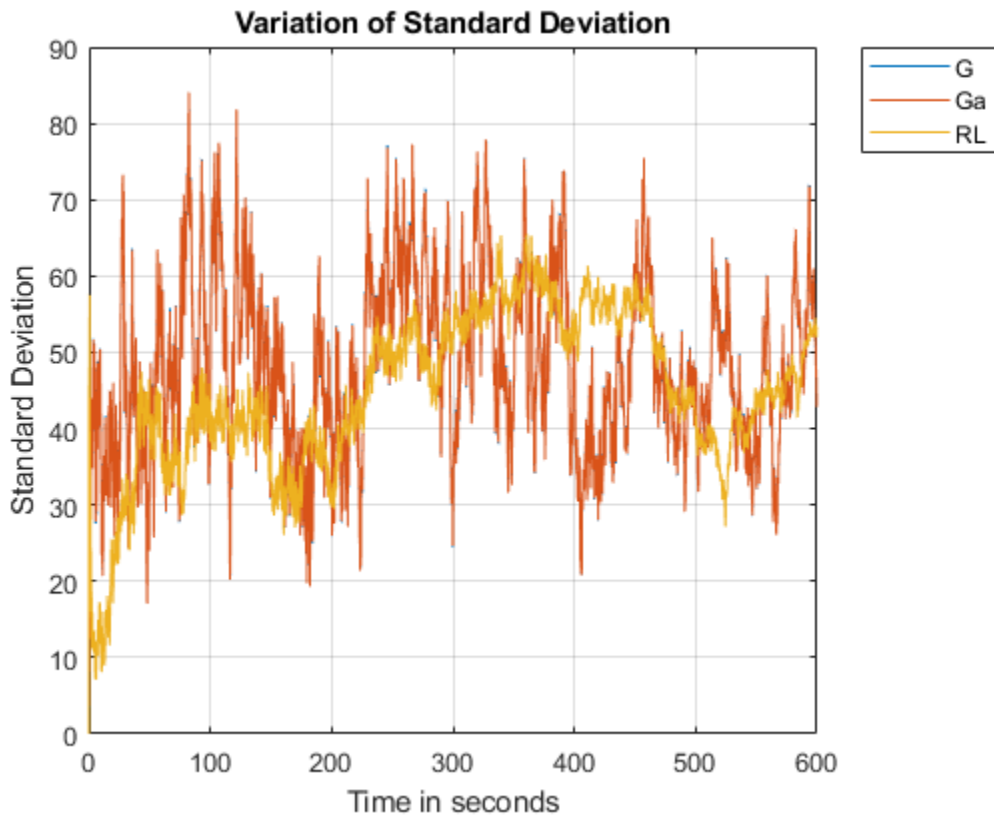

From these plots it appears that G and Ga have exactly identical standard deviations, though the variation of their means is different. Let's see if we can find out why that is so. The first step would be to figure out if there is any relationship between them. Let's look at the reactions in the model once again to see if anything is obvious.

m1.Reactions

```
ans =
  SimBiology Reaction Array

  Index:   Reaction:
  1        L + R <-> RL
  2        R <-> null
  3        RL -> null
  4        Gd + Gbg -> G
  5        G + RL -> Ga + Gbg + RL
  6        Ga -> Gd
```

Moiety Conservation

From the reactions, the relationship between G and Ga is not quite clear. To analyze further we are going to use `sbioconsmoiety` to see if there is any moiety conservation.

```
sbioconsmoiety(m1, 'semipos', 'p')

ans = 2x1 cell
      {'G + Gbg' }
```



```
{'G + Gd + Ga'}
```

From this we can see that 'G + Gd + Ga' is always conserved. But that does not completely explain why the variances of G and Ga are identical. What about Gd? Why doesn't its variance affect G or Ga? To look into it further, let's compute the ensemble statistics for Gd and plot their variation.

```
[timeValsGd, meanValsGd, varianceValsGd] = sbioensemblestats(simdata, 'Gd');
figure;
plot(timeValsGd, meanValsGd, '-', ...
      timeValsGd, sqrt(varianceValsGd), 'r:');
axis([-50 600 -500 3000]);
xlabel('Time in seconds');
title('Mean and Standard Deviation of Gd');
legend('Mean', 'Standard Deviation')
```

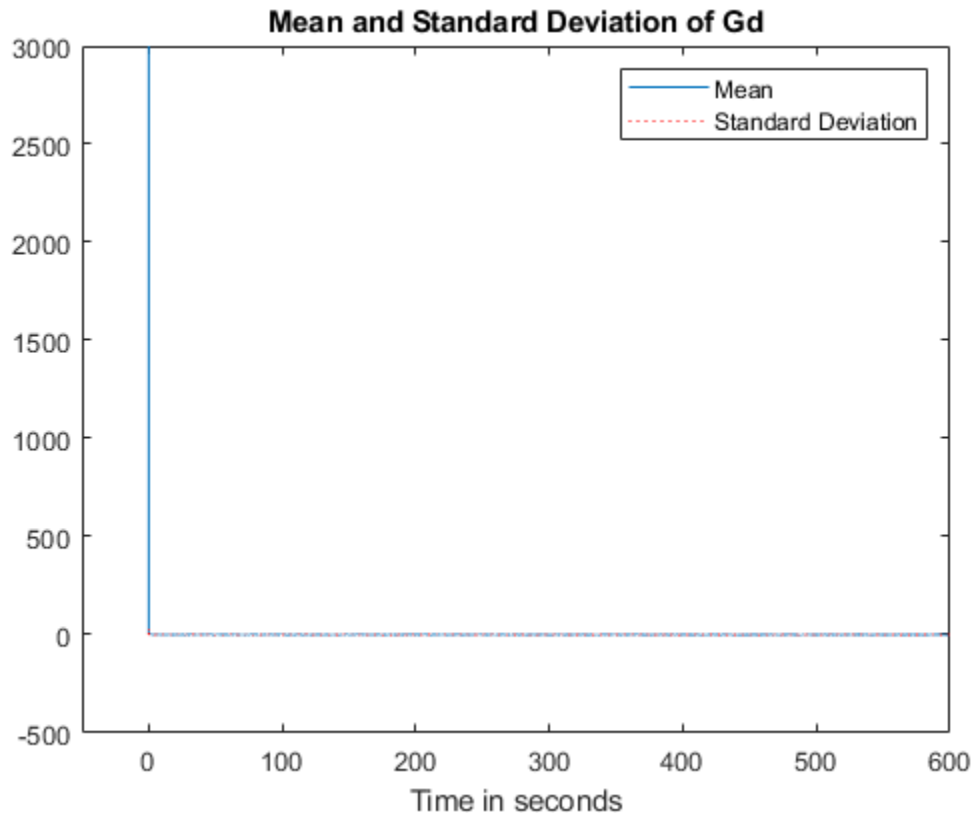

Explanation of Identical Variances

From the plot, it can be seen that Gd starts out with a non-zero value at time = 0, but both its mean and variance approach zero very sharply and stay there. Thus, when Gd stays near zero, the moiety conservation equation reduces to

$$G + Ga \approx \text{constant}$$

This means as G goes up Ga goes down by an equal amount and vice versa. This explains why the variances of G and Ga are almost identical. If you look at the data in matrix varianceVals, you'll see

that the two variances are very close but not exactly equal. This is due to the presence of Gd which is very close to zero but not exactly zero.

Ensemble Plots: 2D Distribution Plots

One way to visualize stochastic ensemble data is to plot histograms of species concentrations at particular time points. Each histogram shows the distribution of concentrations for a particular species over the entire ensemble of runs. These histograms may be generated using the SimBiology command `sbioensembleplot`.

Let's create histograms for the species G, Ga, and RL at time $t = 10$. Note that in this example, we generated the ensemble data without specifying an interpolation option for `sbioensamplerun`. The time vectors for each run within the ensemble are therefore different from each other. `sbioensembleplot` interpolates the simulation data to find species amounts for every run at the precise time $t = 10$.

```
sbioensembleplot(simdata, speciesNames, 10);
```

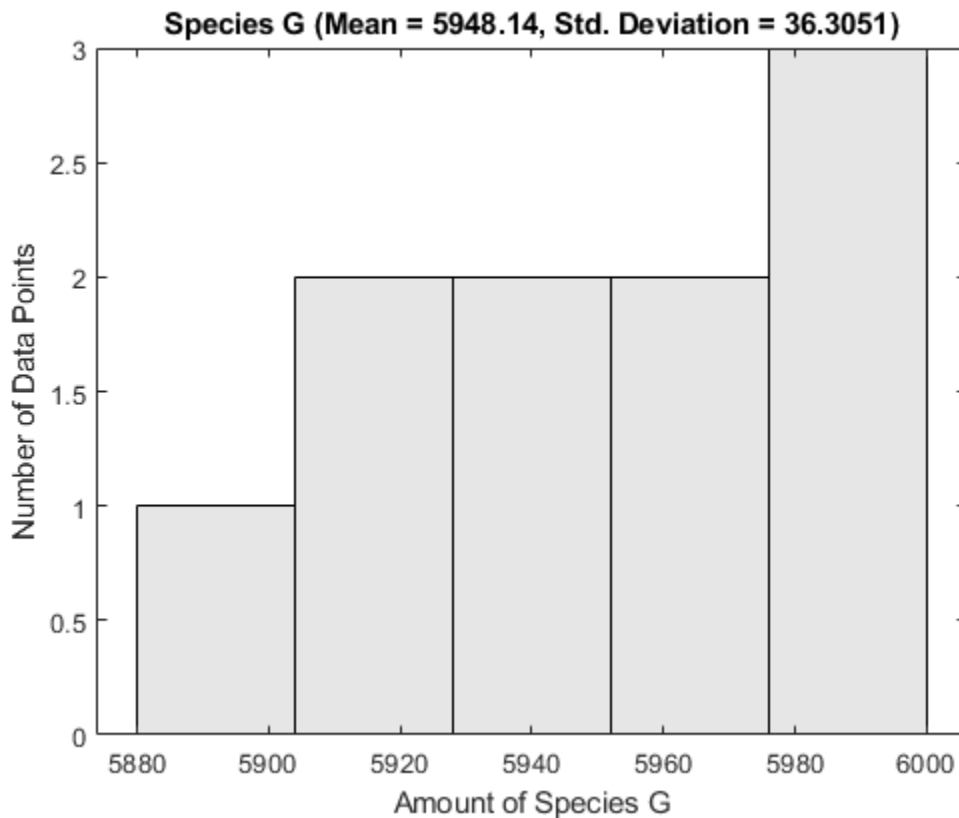

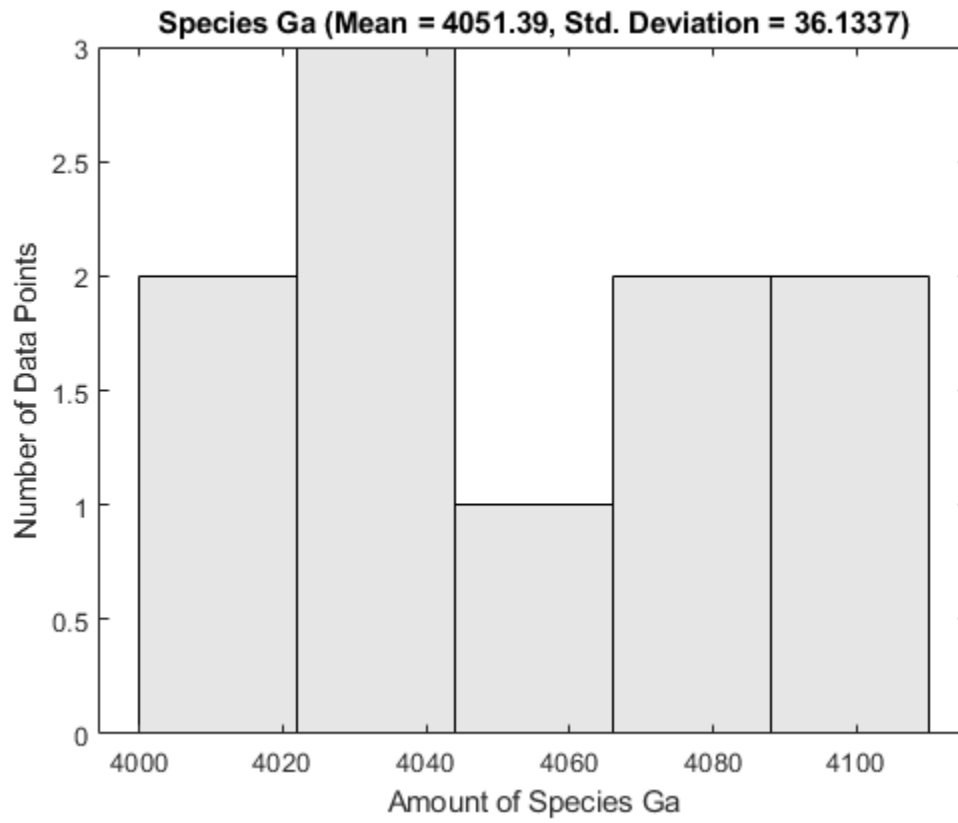

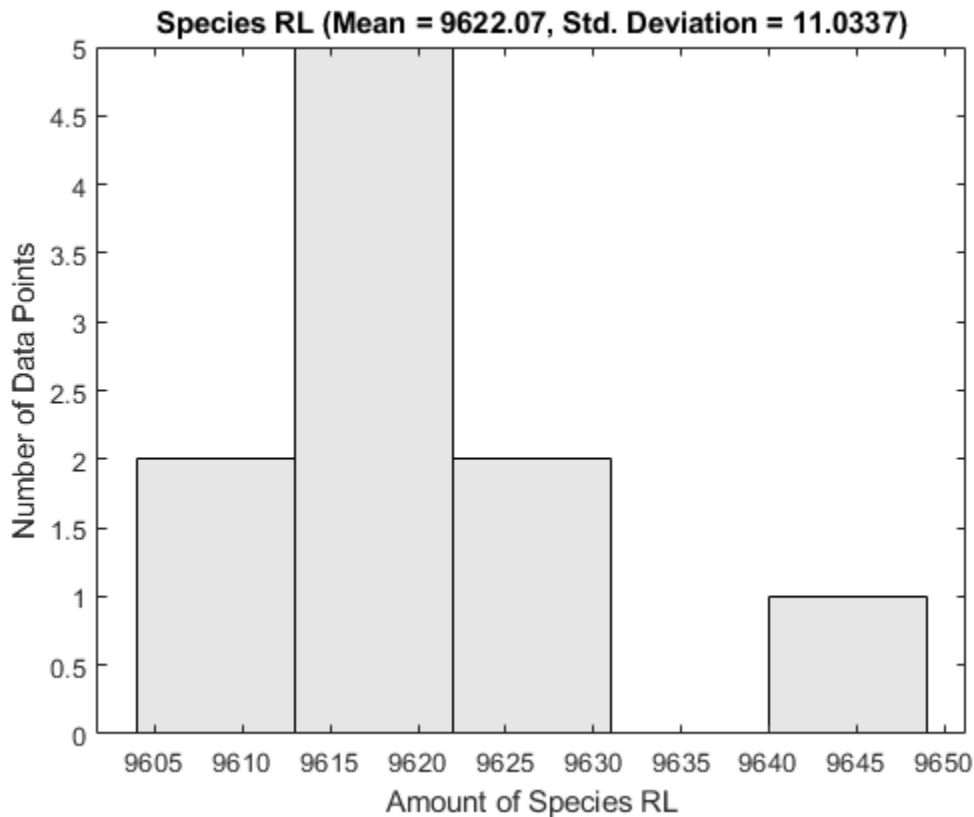

Ensemble Plots: 3D Mountain Plots

It is clear that to get a full understanding of how the distribution changes with time, you will need to make these distribution plots at every time interval of interest. Moreover, the distribution plots need to be seen along with the mean and variance plots. It would be nice to put all of this information together in just one plot.

Well, the 3D ensemble data plots do exactly that. With these 3D plots you can view how mean and variance change as a function of time. In addition, instead of having to plot the distribution of species at every possible time step, in one view you can see how a fitted normal distribution, with the same mean and variance as the actual data, changes with time. The 3D ensemble plot is excellent for getting an overview of how mean, variance and distribution vary as a function of time.

Let's see a 3D ensemble plot of species Ga.

```
sbioensembleplot(simdata, 'Ga');
```

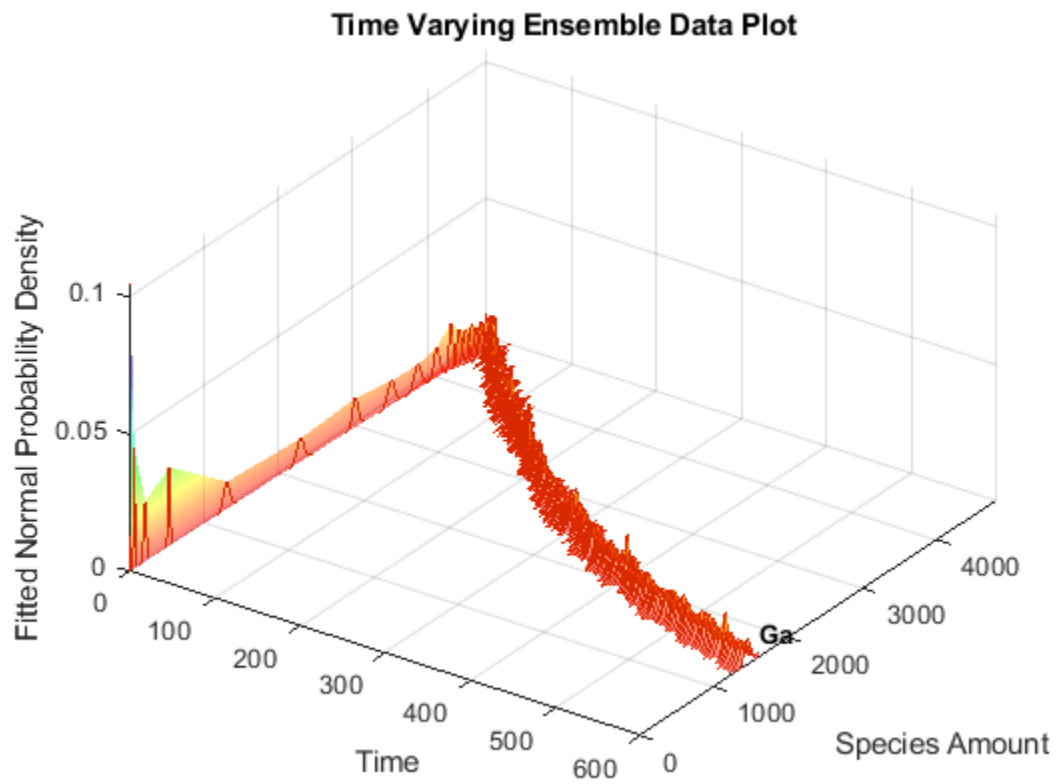

This example showed how stochastic ensemble data of SimBiology models can be analyzed using various tools in SimBiology.

Deploy a SimBiology Model Using SimFunction

This example shows how to compile a SimBiology model using `SimFunction` and MATLAB Compiler and create a web app archive to deploy in MATLAB Web App Server. The example uses a tumor growth model that focuses on the target or receptor occupancy (TO) as a biomarker and explores the dosing efficacy and toxicity.

Target-Mediated Drug Disposition (TMDD) Model

Target-mediated drug disposition is a phenomenon in which a drug binds with high affinity to its pharmacologic target site, such as a receptor or enzyme, in an interaction that is reflected in the pharmacokinetic characteristics of the drug. For details about the model, see “Scan Dosing Regimens Using SimBiology Model Analyzer App” on page 1-108.

Load the model.

```
sbioloadproject tmdd_with_T0.sbproj;
```

Get Dosing Information

Get the dosing information. The dose object name is *Adaptive amount*. The object has its amount property parameterized so that you can change the dose amount property by changing another model parameter (*Amount*).

```
dose = getdose(m1,"Adaptive amount")
```

```
dose =
  SimBiology Dose Array

  Index:      Name:              Type:
  1          Adaptive amount    repeat
```

Generate a dosing table from the dose object to reuse it later.

```
doseTable = getTable(dose)
```

```
doseTable=1x5 table
  StartTime      Amount      Rate      Interval      RepeatCount
  _____  _____  _____  _____  _____
           0      {'Amount'}      0           24           6
```

Create SimFunction

Create a `SimFunction` object that creates a function-like interface to let you vary the dose amount and simulate the model response (target occupancy).

```
input = "Amount";
output = "TO";
% Suppress informational warning about dosing.
warning('off', 'SimBiology:SimFunction:DOSES_NOT_EMPTY');
simFun = createSimFunction(m1,input,output,dose);
```

Accelerate the `SimFunction` object for faster simulation in the deployed app.

```

accelerate(simFun);
% Restore the warning.
warning('on', 'SimBiology:SimFunction:DOSES_NOT_EMPTY');

```

Simulate Model

Run the SimFunction object and check the target occupancy for a given dose amount.

```

doseAmount = 100;
stopTime = 8; % Simulate for 8 days
results = simFun(doseAmount, stopTime, doseTable);

```

Plot the target occupancy. Define the safety threshold as 0.8 and efficacy threshold as 0.2.

```

lh = plot(results.Time, results.Data, Linewidth=2);
yline(0.8, 'r--', "safety", LabelVerticalAlignment="middle", Linewidth=2);
yline(0.2, 'g--', "efficacy", LabelVerticalAlignment="middle", Linewidth=2);
ylim([-0.05, 1.05]);
axis padded
xlabel("Time (days)")
ylabel("Target Occupancy")

```

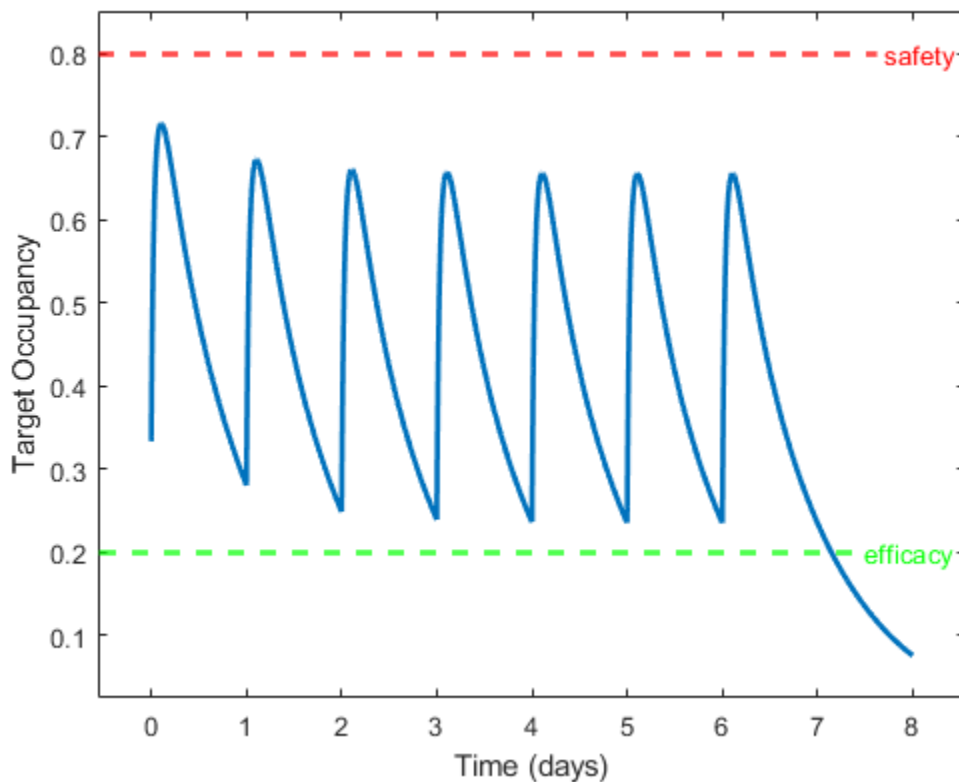

Save SimFunction and dosing information as a MAT file to reuse in the deployed app.

```

save tmdd_simfun_dosetable.mat simFun doseTable

```

Compile Application and Create Web App Archive

A prebuilt MATLAB app, `app_tmdd_with_T0.mlapp`, has a simple slider to control the dose amount. The app simulates the model each time you change the slider value and plots the corresponding time course of the target occupancy. On startup, the app loads the necessary `SimFunction` and dose table from the MAT file you saved previously. To learn how to build such MATLAB apps, see “Develop Apps Using App Designer”.

The next steps show you how to compile such an app with additional dependent files needed to create a web app archive that can run on MATLAB Web App Server.

```
appfilename = "app_tmdd_with_T0.mlapp";
```

To check the dependent files required by `SimFunction`, uncomment the following.

```
% simFun.DependentFiles'
```

Specify the MAT file and `SimFunction` dependent files as the required dependencies for the app.

```
appDependencies = ["tmdd_simfun_dosetable.mat";simFun.DependentFiles'];
```

Build the web app archive.

```
compiler.build.webAppArchive(appfilename,AdditionalFiles=appDependencies);
```

The build function generates a folder named `app_tmdd_with_T0webAppArchive` with the necessary files needed for deployment in MATLAB Web App Server. For details, see “Deploy Web App” (MATLAB Compiler).

See Also

SimBiology Model Builder | **SimBiology Model Analyzer** | **Application Compiler** | `compiler.build.standaloneApplication` | `compiler.build.webAppArchive`

Related Examples

- “Deploy a SimBiology Exported Model” on page 4-125
- “Develop Apps Using App Designer”
- “Deploy Web App” (MATLAB Compiler)

Deploy a SimBiology Exported Model

This example shows how to deploy a graphical application that simulates a SimBiology® model. The example model is the Lotka-Volterra reaction system as described by Gillespie [1], which can be interpreted as a simple predator-prey model.

This example requires MATLAB Compiler™.

Overview

You can create standalone SimBiology applications using MATLAB Compiler and the SimBiology exported model. To make your application compatible with MATLAB Compiler, do the following:

- Create an exported model, using the model's `export` method.
- Accelerate the model (optional).
- Save the model to a MAT file.
- Ensure your application loads the model from the MAT file.
- Add the `%%function` pragma to the application's top-level function.
- Call the `compiler.build.standaloneApplication` function, explicitly adding the MAT file and the exported model's dependent files to the application.

Load the Model

```
sbioloadproject lotka m1
```

Create the Exported Model

```
exportedModel = export(m1);
```

Accelerate the Model

Acceleration requires a correctly configured MEX compiler (see the documentation for `mex -setup`).

```
accelerate(exportedModel);
```

Save the Exported Model

Save the model in a MAT file.

```
save exportedLotka exportedModel
```

Compile and Build Standalone Application

The code that builds an application for the purposes of this example is provided in `simulateLotkaGUI.m`. The app lets you vary the Lotka-Volterra model parameter values with sliders and plots the prey and predator populations. It uses the exported model from the MAT file. The code also contains the following `%%function` pragma, which tells the MATLAB Compiler that the application uses a SimBiology exported model: `%%function SimBiology.export.Model`.

```
appfile = fullfile(matlabroot,"toolbox","simbio","simbiodemos","simulateLotkaGUI.m");
```

If you want to see what the app looks like, you can open the file and hit **Run** on the toolstrip.

Next, specify the list of dependency files that are needed for the application. This list includes the MAT file containing the exported model and any files listed in the `DependentFiles` property of the exported model.

```
appDependencies = ["exportedLotka.mat";string(exportedModel.DependentFiles)'];
```

Define the standalone application build options that contain the app file and dependency files.

```
opts = compiler.build.StandaloneApplicationOptions(appfile,AdditionalFiles=appDependencies);
```

Create a deployable standalone application using MATLAB Compiler. It creates a folder named `simulateLotkaGUIstandaloneApplication` that contains an executable file that you can deploy.

```
if ispc
    compiler.build.standaloneWindowsApplication(opts);
else
    compiler.build.standaloneApplication(opts);
end
```

Compile Using `mcc` As an Alternative Approach

You can also use the `mcc` command to build the standalone application. Note that the MAT file must be loaded into the workspace before `mcc` is called, so that the exported model's files are available for deployment.

To speed compilation, use the option `-N -p simbio`, which informs `mcc` that the deployed application does not depend on any additional toolboxes. For the purposes of this example, programmatically construct the `mcc` command.

```
mccCommand = ['mcc -m simulateLotkaGUI.m -N -p simbio -a exportedLotka.mat ' ...
    sprintf(' -a %s', exportedModel.DependentFiles{:})];
%
% eval(mccCommand)
```

References

- [1] Gillespie, Daniel T. "Exact Stochastic Simulation of Coupled Chemical Reactions." *The Journal of Physical Chemistry* 81, no. 25 (December 1977): 2340-61.

See Also

`SimBiology.export.Model` | `compiler.build.standaloneApplication` | `compiler.build.webAppArchive`

Related Examples

- "Deploy a SimBiology Model Using `SimFunction`" on page 4-122
- "Develop Apps Using App Designer"
- "Deploy Web App" (MATLAB Compiler)

Parameter Scanning, Parameter Estimation, and Sensitivity Analysis in the Yeast Heterotrimeric G Protein Cycle

This example shows how to build, simulate and analyze a model in SimBiology® using a pathway taken from the literature.

Reference

A quantitative characterization of the yeast heterotrimeric G protein cycle. Tau-Mu Yi, Hiroaki Kitano, and Melvin I. Simon. PNAS (2003) vol. 100, 10764-10769.

Aims

- Create a model for the yeast TMY101(wt) strain that shows the wild-type (catalyzed) rate of G-Protein inactivation.
- Create a variant for the TMY111(mut) strain that shows the mutant (uncatalyzed) rate of G-Protein inactivation.
- Simulate and store the data from the two models.
- Compare the timecourse for G-Protein activation between the wild-type pathway, mutant pathway, and experimental data.
- Perform a parameter scan to determine the effect of varying the value of a parameter on a species of interest.
- Estimate model parameter values using experimental data.
- Perform sensitivity analysis to determine which and to what extent model parameters affect a species of interest.

Background

In the yeast *Saccharomyces cerevisiae*, G protein signaling in the mating response is a well characterized signal transduction pathway. The pheromone secreted by alpha cells activates the G-protein coupled alpha-factor receptor (Ste2p) in 'a' cells which results in a variety of cell responses including cell-cycle arrest and synthesis of new proteins. G proteins and G protein coupled receptors (GPCRs) are the focus of drug discovery efforts in the pharmaceutical industry. Many marketed drugs target GPCRs - some examples include those for reducing stomach acid (ranitidine, targets histamine H2 receptor), migraine (sumatriptan, targets a serotonin receptor subtype), schizophrenia (olanzapine, targets serotonin and dopamine receptors), and allergies (desloratadine, targets histamine receptors). Further, some estimates suggest that GPCRs are the targeted focus of 40% of drug discovery efforts. One approach is to model GPCR signaling pathways to analyze and predict both downstream effects and effects in related pathways. This example examines model building, simulation, and analysis of the G protein cycle in the yeast pheromone response pathway.

This figure is a graphical representation of the conceptual framework used to model the yeast G protein cycle.

The following abbreviations are used:

- L = Ligand
- R = Receptor

- Gd = G alpha- GDP
- Gbg = free levels of G beta-gamma
- Ga = G alpha - GTP
- G = inactive heterotrimeric G-Protein (contains G alpha and G beta-gamma)
- null = source or sink
- Sst2 denotes the G protein regulator (RGS) Sst2p

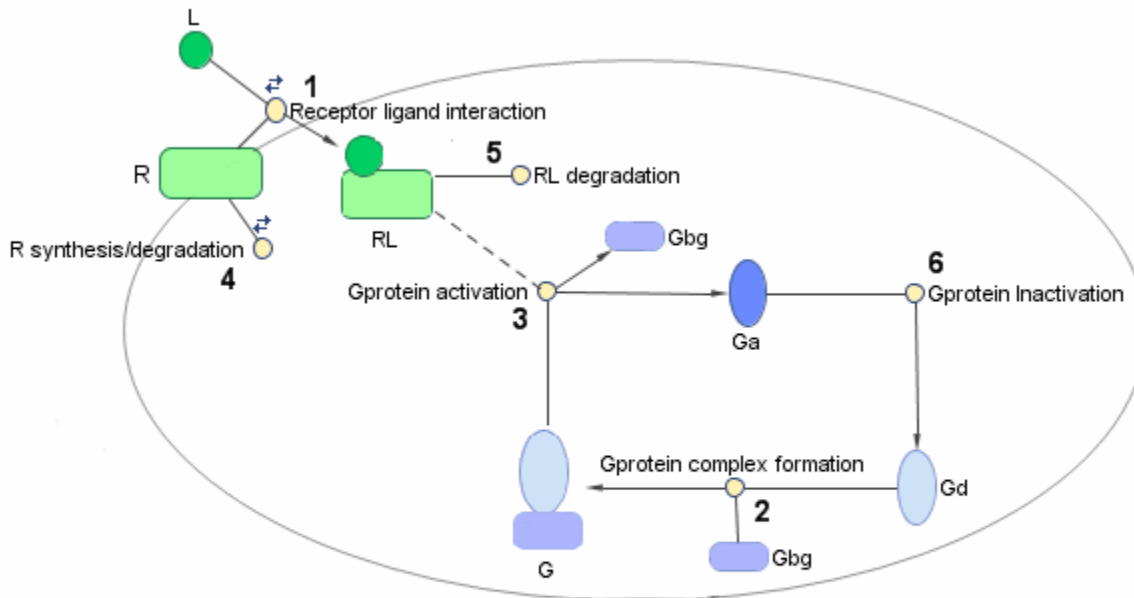

Graphical Representation of the G protein cycle in yeast pheromone response. The numbers represent reaction numbers referenced in the text. L = Ligand (alpha factor), R = alpha-factor receptor, Gbg = free levels of G-beta:G-gamma complex, Ga = active G-alpha-GTP, Gd = inactive G-alpha-GDP, G = inactive Gbg:Gd complex.

Pathway Reactions

As shown in the figure, the cycle can be condensed into a set of biochemical reactions:

1) Receptor-Ligand Interaction (reversible reaction)

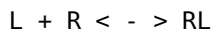

2) Heterotrimeric G-Protein formation



3) G-Protein activation - Note below that RL appears on both sides of the equation because RL is a modifier or catalyst for the reaction. RL is neither produced nor consumed by this reaction.

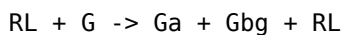

4) Receptor synthesis and degradation (treated as reversible reaction to represent degradation and synthesis)

```
R <-> null
```

5) Receptor-ligand degradation

```
RL -> null
```

6) G-Protein inactivation, catalyzed by Sst2p in wild-type strain TMY101 and uncatalyzed in mutant strain TMY111 with a disruption in the SST2 gene.

```
Ga -> Gd
```

All values have been converted to molecule for species amounts, and molecule/second, or 1/second for rate parameters.

Building a SimBiology® Model for the Wild-Type Pathway

Create a SimBiology model object with the name 'Heterotrimeric G Protein wt'.

```
modelObj = sbiomodel('Heterotrimeric G Protein wt');
```

Add the Receptor-Ligand interaction (reversible reaction).

```
reactionObj1 = addreaction(modelObj, 'L + R <-> RL', ...
    'Name', 'Receptor-ligand interaction');
```

Use a 'MassAction' kinetic law for the reaction. This model is built using mass action kinetics for all reactions.

```
kineticlawObj1 = addkineticlaw(reactionObj1, 'MassAction');
```

Add the forward and reverse rate parameters.

```
addparameter(modelObj, 'kRL', 3.32e-18);
addparameter(modelObj, 'kRLm', 0.01);
```

Assign ParameterVariableNames in the kinetic law object. This maps ParameterVariables to ParameterVariableNames in the kinetic law object so that the reaction rate can be determined.

```
kineticlawObj1.ParameterVariableNames = {'kRL', 'kRLm'};
```

SimBiology automatically creates species objects for each of the participating species in the reactions. Set the initial amounts of these species.

```
% Set initial amount for 'L'
modelObj.Reactions(1).Reactants(1).InitialAmount = 6.022E17;
% Set initial amount for 'R'
modelObj.Reactions(1).Reactants(2).InitialAmount = 10000.0;
% Leave initial amount for 'RL' at default value (0.0)
```

The ReactionRate for the first reaction has now been configured.

```
reactionObj1.ReactionRate
```

```
ans =
```

```
'kRL*L*R - kRLm*RL'
```

Completing the Wild-Type Model

To create the model of the wild-type strain (TMY101), add the rest of the reactions and parameters, create kinetic law objects for each of the reactions, and assign parameter variables for the kinetic laws.

Add and configure the reaction for Heterotrimeric G-Protein formation.

```
reactionObj2 = addreaction(modelObj, 'Gd + Gbg -> G', ...
    'Name', 'G protein complex formation');
kineticlawObj2 = addkineticlaw(reactionObj2, 'MassAction');
addparameter(modelObj, 'kG1', 1.0);
kineticlawObj2.ParameterVariableNames = 'kG1';
% Set initial amount for 'Gd'
modelObj.Reactions(2).Reactants(1).InitialAmount = 3000;
% Set initial amount for 'Gbg'
modelObj.Reactions(2).Reactants(2).InitialAmount = 3000;
% Set initial amount for 'G'
modelObj.Reactions(2).Products(1).InitialAmount = 7000;
```

Add and configure the reaction for G-Protein activation.

```
reactionObj3 = addreaction(modelObj, 'G + RL -> Ga + Gbg + RL', ...
    'Name', 'G protein activation');
kineticlawObj3 = addkineticlaw(reactionObj3, 'MassAction');
addparameter(modelObj, 'kGa', 1.0E-5);
kineticlawObj3.ParameterVariableNames = 'kGa';
% Set initial amount for 'Ga'
modelObj.Reactions(3).Products(1).InitialAmount = 0.0;
```

Add and configure the reaction for receptor synthesis and degradation.

```
reactionObj4 = addreaction(modelObj, 'R <-> null', ...
    'Name', 'R synthesis/degradation');
kineticlawObj4 = addkineticlaw(reactionObj4, 'MassAction');
addparameter(modelObj, 'kRdo', 4.0E-4);
addparameter(modelObj, 'kRs', 4.0);
kineticlawObj4.ParameterVariableNames = {'kRdo', 'kRs'};
```

Add and configure the reaction for receptor-ligand degradation.

```
reactionObj5 = addreaction(modelObj, 'RL -> null', 'Name', 'RL degradation');
kineticlawObj5 = addkineticlaw(reactionObj5, 'MassAction');
addparameter(modelObj, 'kRD1', 0.0040);
kineticlawObj5.ParameterVariableNames = 'kRD1';
```

Add and configure the reaction for G-Protein inactivation.

```
reactionObj6 = addreaction(modelObj, 'Ga -> Gd', 'Name', 'Gprotein inactivation');
kineticlawObj6 = addkineticlaw(reactionObj6, 'MassAction');
addparameter(modelObj, 'kGd', 0.11);
kineticlawObj6.ParameterVariableNames = 'kGd';
```

Check the ReactionRate of all the reactions.

```
get(modelObj.Reactions, {'Reaction', 'ReactionRate'})
```

```
ans =
```

6x2 cell array

```
{'L + R <-> RL'           } {'kRL*L*R - kRLm*RL'}
{'Gd + Gbg -> G'          } {'kG1*Gd*Gbg'         }
{'G + RL -> Ga + Gbg + RL'} {'kGa*G*RL'           }
{'R <-> null'             } {'kRdo*R - kRs'        }
{'RL -> null'             } {'kRD1*RL'            }
{'Ga -> Gd'               } {'kGd*Ga'              }
```

Simulating the Wild-Type Model and Plotting the Results

To note the fast rise and subsequent decline of the species Ga, simulate the model for 600s and store the results.

Change the StopTime of the default configuration set object from 10s (simulationTime) to 600s. In addition, don't log data for the ligand 'L' (modelObj.Species(1)) because it takes on values that are orders of magnitude higher than the other species. This makes visualizing the species in a plot more convenient. To accomplish this, define StatesToLog to include all species except 'L'.

```
configsetObj = getconfigset(modelObj);
configsetObj.StopTime = 600;
configsetObj.SolverOptions.AbsoluteTolerance = 1.e-9;
configsetObj.RuntimeOptions.StatesToLog = ...
    sbioselect(modelObj, 'Type', 'species', 'Where', 'Name', '~=', 'L');
```

Simulate the model and return the results to the three variables 'time', 'data', and 'names'.

```
[time, data, names] = sbiosimulate(modelObj);
```

Plot the data.

```
plot(time, data);
legend(names, 'Location', 'NorthEastOutside');
xlabel('Time (seconds)');
ylabel('Species Amounts');
grid on;
```

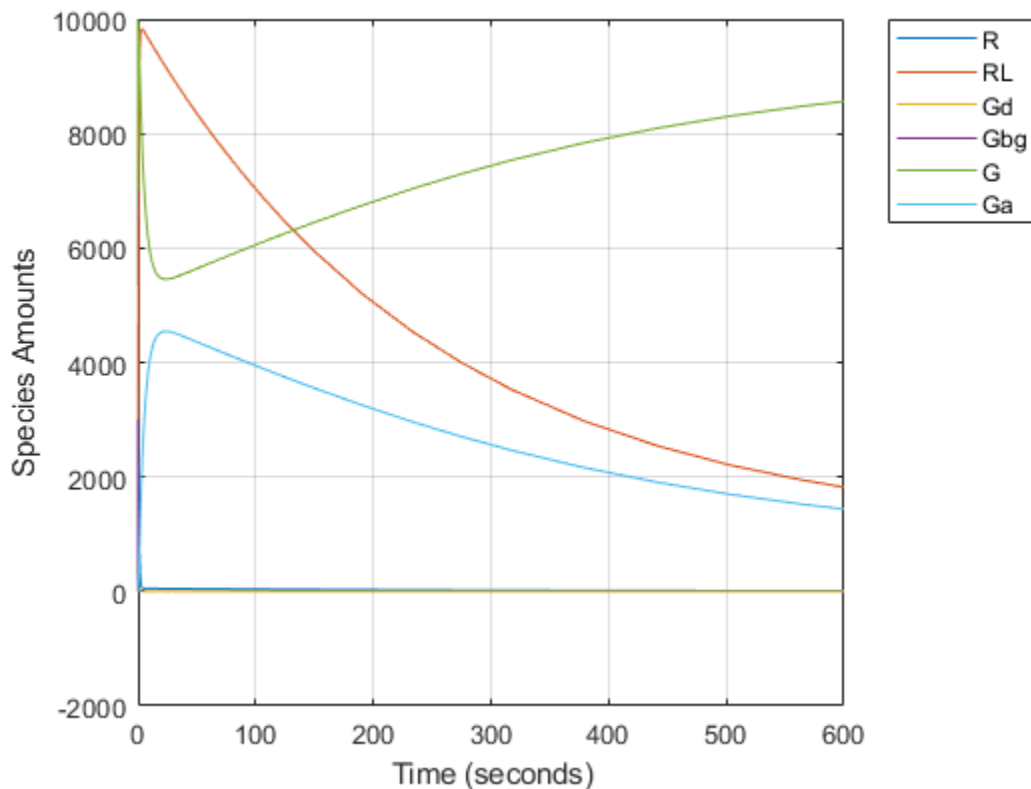

Creating a Model Variant for the Mutant Strain

The G-Protein cycle model for the mutant strain differs in the rate at which the inactivation of the active G-protein (Ga) takes place. This rate is governed by the value of the rate parameter k_{Gd} . You can represent the mutant strain using a Variant object. A SimBiology Variant stores alternate values for one or more properties of a SimBiology model, such as the InitialAmount of a species or the Value of a parameter.

Add a variant named 'mutant' to the model.

```
variantObj = addvariant(modelObj, 'mutant');
```

Add content to the variant to specify an alternate value of 0.004 for the parameter k_{Gd} .

```
addcontent(variantObj, {'parameter', 'kGd', 'Value', 0.004});
```

Simulating the Mutant Pathway and Plotting the Results

Simulate the model using the mutant variant object. This applies the value of 0.004 to the parameter k_{Gd} during simulation. Return the simulation results in a SimData object. In addition to storing SimBiology simulation data, SimData objects provide methods for data access, plotting, and analysis.

Set the Active property of the mutant variant object to true and simulate.

```
variantObj.Active = true;
mutantData = sbiosimulate(modelObj);
```

Plot the data using dashed lines. See also `sbioplot` for convenient plotting of SimData objects.

```

plot(mutantData.Time, mutantData.Data, 'LineStyle', '--');
legend(mutantData.DataNames, 'Location', 'NorthEastOutside');
xlabel('Time (seconds)');
ylabel('Species Amounts');
grid on;

```

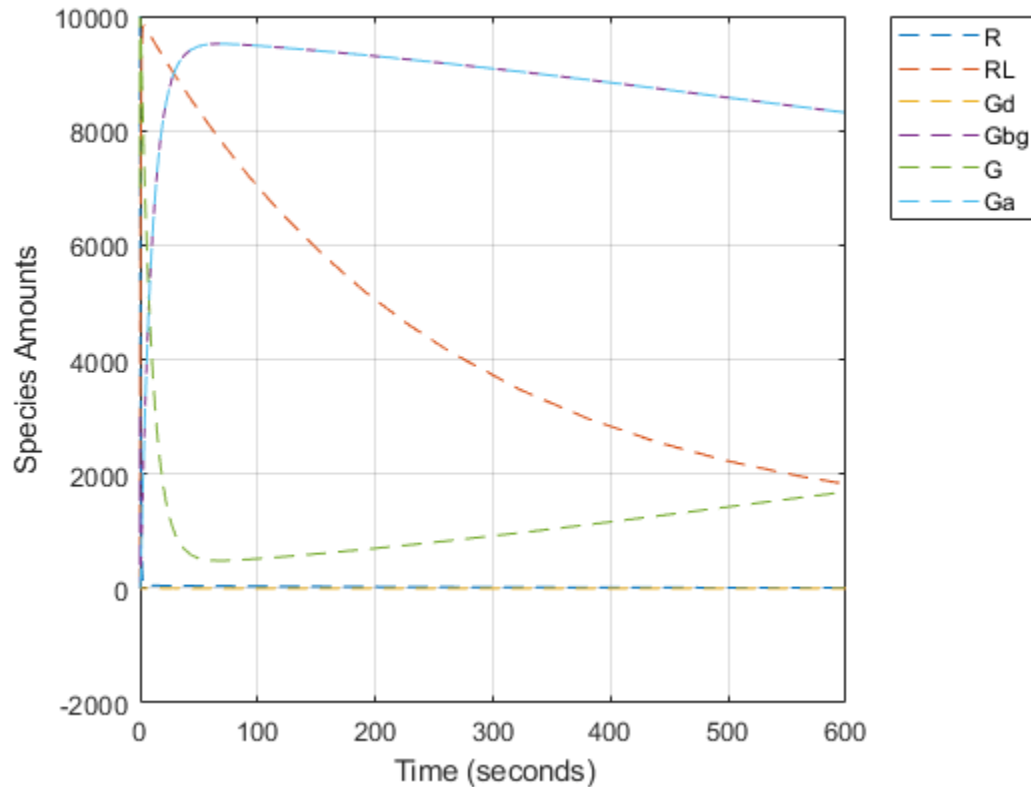

Compare the behavior of the active G-Protein species (Ga) in the wild-type and mutant pathways.

```

GaIndex = strcmp(names, 'Ga'); % index for wild-type results
[tmut, xmut] = selectbyname(mutantData, 'Ga');
plot(time, data(:,GaIndex), tmut, xmut, '--');
xlabel('Time (seconds)');
ylabel('Species Amounts');
legend({'Ga (wt)', 'Ga (mutant)'}, 'Location', 'NorthEastOutside');
grid on;

```

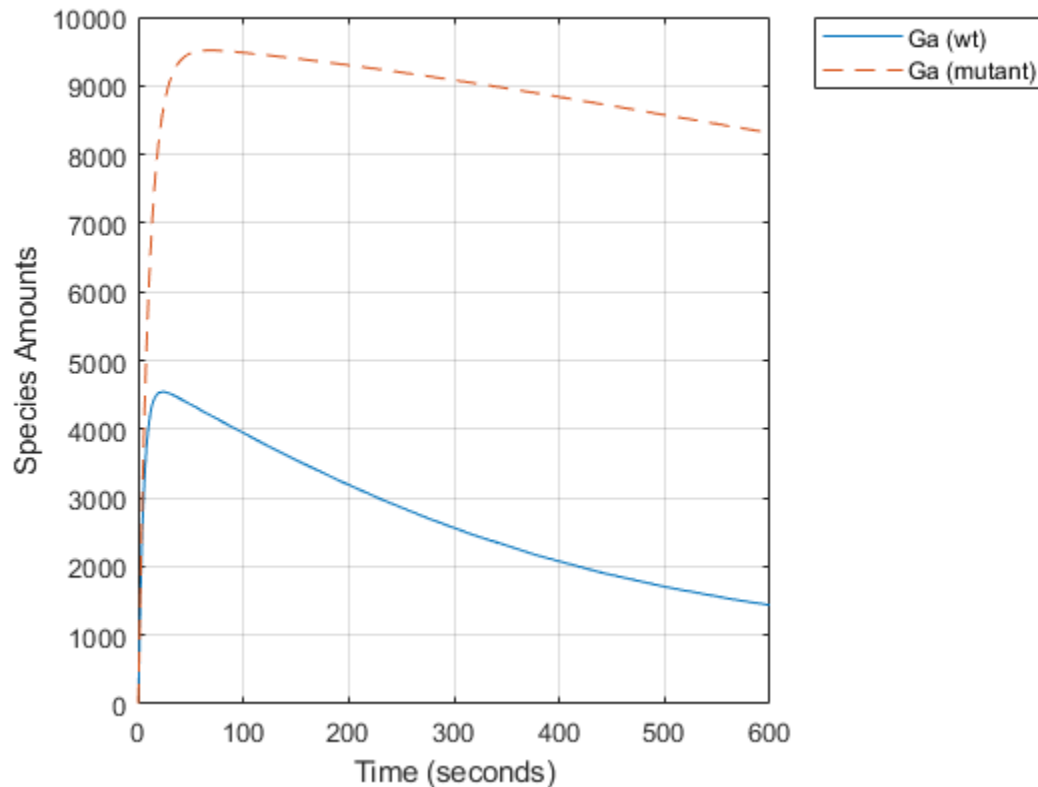

Performing a Parameter Scan

The rate of G-protein inactivation is much lower in the mutant strain relative to the wild-type ($k_{Gd} = 0.004$ vs $k_{Gd} = 0.11$), which explains the higher levels of activated G-protein (Ga) over time observed in the above comparison. For a more detailed look at how the variation of k_{Gd} affects levels of Ga, perform a parameter scan of several simulations in which the value of k_{Gd} is varied over a range of values. The following example illustrates a parameter scan over five values of k_{Gd} ; to increase the number of iterations, change the values in the arguments for the `linspace` function below.

Generate five evenly-spaced k_{Gd} values ranging from 0.001 to 0.15.

```
kGdValues = linspace(1e-3, 0.15, 5);
```

Store the results of the parameter scan in an array of `SimData` objects. Initialize a variable to hold this array.

```
scanData = [];
```

Prepare the model for accelerated simulation.

```
sbioaccelerate(modelObj);
```

Loop over `kGdValues` and perform a simulation for each value. Use the mutant variant on the model to modify the value of k_{Gd} used during simulation.

```
for kGd = kGdValues
    % Set the desired value of kGd in the variant.
```

```
variantObj.Content{1}{4} = kGd;  
  
% Simulate the model, storing the results in a SimData object.  
sd = sbiosimulate(modelObj);  
scanData = [scanData; sd];  
end
```

`scanData` is now a five element array of `SimData` objects. Each object contains the data from one run in the parameter scan.

Extract the timecourses for `Ga` from the `SimData` object array and plot on a single axis. The following code constructs the plot step-by-step; alternatively, see `sbioplot` and `sbiosubplot`.

```
[tscan, xscan] = selectbyname(scanData, 'Ga');  
  
fh = figure;  
hold on;  
for c = 1:5  
    plot(tscan{c}, xscan{c});  
    str = sprintf(' k = %5.3f', kGdValues(c));  
    text(tscan{c}(end), xscan{c}(end), str);  
end  
  
% Annotate the plot.  
axis(gca(fh), 'square');  
title('Varying the Value of kGd: Effect on Ga');  
xlabel('Time (seconds)');  
ylabel('Species Amounts');  
grid on;  
hold off;
```

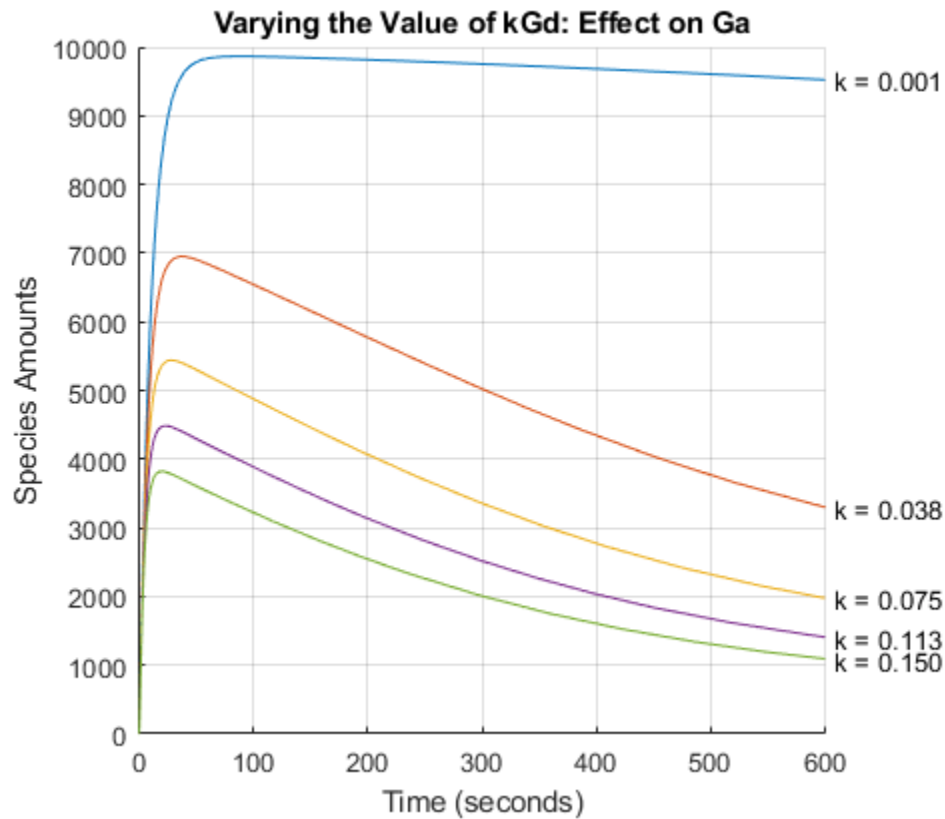

Parameter Estimation - Background

When modeling biological systems, it is often necessary to include parameters whose numerical value is unknown or only roughly known. If experimental data is available for one or more species in the system, the values of these parameters can be estimated by varying them and looking for those values which lead to the best fit between the model's simulated results and the experimental data.

In this section of the example we explore parameter estimation functionality in the context of trying to fit the G protein model to experimental data.

Parameter Estimation - Comparing Model Results to Experimental Data

For experimental data, Fig. 5 of the reference paper contains the timecourse for the fraction of active G protein.

Store the experimental time and state data.

```
tExpt = [0 10 30 60 110 210 300 450 600]';
GaFracExpt = [0 0.35 0.4 0.36 0.39 0.33 0.24 0.17 0.2]';
data = groupedData(table(tExpt, GaFracExpt));
data.Properties.IndependentVariableName = 'tExpt';
```

Instead of converting this experimental data to absolute amounts of Ga, add this fraction to the model using a non-constant parameter and a repeatedAssignment rule.

```
GaFracObj = modelObj.addparameter('GaFrac', 'ConstantValue', 0);
GaFracRule = modelObj.addrule('GaFrac = Ga / (Ga + G + Gd)', 'repeatedAssignment');
```

GaFracRule =

SimBiology Rule Array

Index:	RuleType:	Rule:
1	repeatedAssignment	GaFrac = Ga / (Ga + G + Gd)

Change the RuntimeOptions on the configuration set to log GaFrac.

```
configsetObj.RuntimeOptions.StatesToLog = GaFracObj;
```

Deactivate the mutant variant.

```
variantObj.Active = false;
```

Simulate the model, storing the results in a SimData object.

```
sdWild = sbiosimulate(modelObj);
```

Get the data for 'GaFrac' to be used later in a plot.

```
[tWild, GaFracWild] = selectbyname(sdWild, 'GaFrac');
```

Resample the simulation results onto the experimental time vector.

```
sdWildResampled = resample(sdWild, tExpt, 'pchip');
```

Get the resampled data for the species 'Ga'.

```
[~, GaFracWildResampled] = selectbyname(sdWildResampled, 'GaFrac');
```

Compute the R-square value measuring the fit between the simulated and experimental data.

```
sst = norm(GaFracExpt - mean(GaFracExpt))^2;
sse = norm(GaFracExpt - GaFracWildResampled)^2;
rSquare = 1-sse/sst;
```

Plot the simulation results against the experimental data for Ga.

```
fh = figure;
plot(tExpt, GaFracExpt, 'ro');
legendText = {'Experiment'};
title('Fit to Experimental Data for GaFrac');
xlabel('Time (seconds)');
ylabel('Species Amount');
hold on;
plot(tWild, GaFracWild);
legendText{end+1} = sprintf('Original, R^2 = %4.2f', rSquare);
legend(legendText{:});
grid on;
```

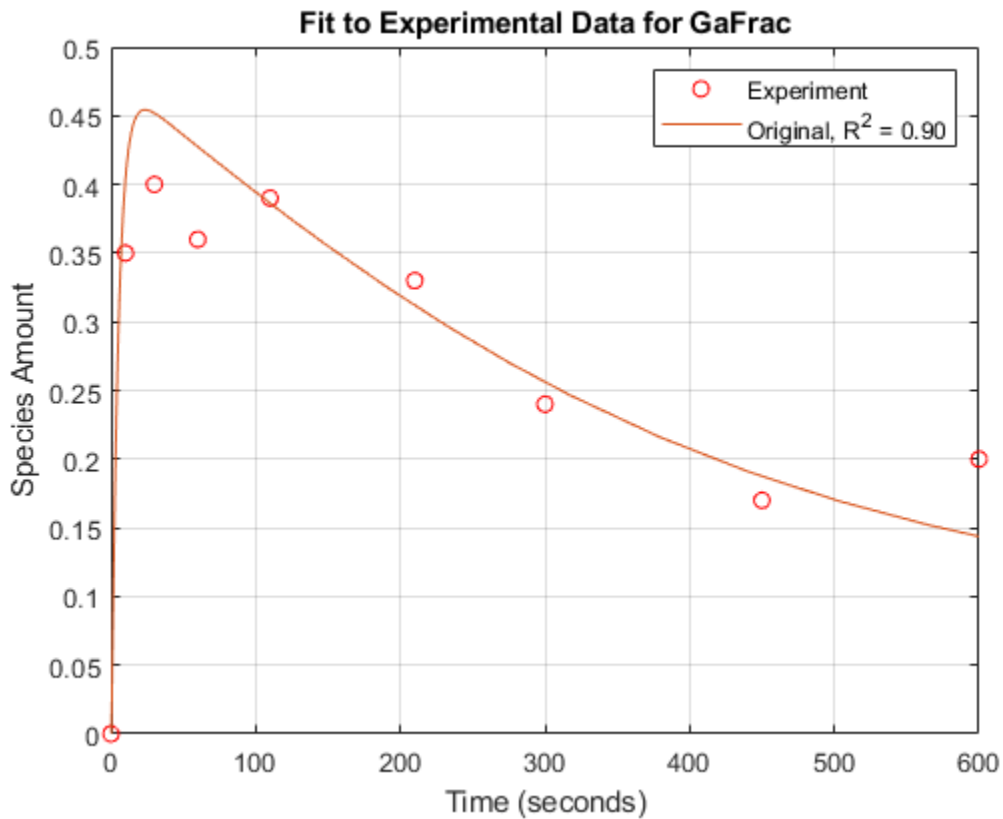

Parameter Estimation - Estimating a Single Model Parameter

From the parameter scan, we've seen that the value of the parameter k_{Gd} has a significant effect on the timecourse of the species Ga. Let's see if we can improve the fit of the model results to the experimental data by varying the value of k_{Gd} .

Perform parameter estimation against the experimental data, optimizing the value of k_{Gd} . Plot information about iterations while the optimization progresses, up to a maximum of 15 iterations.

```
paramToEst = estimatedInfo('kGd');
kGdObj = sbioselect(modelObj, 'Name', 'kGd');
opt = optimset('PlotFcns', @optimplotfval, 'MaxIter', 15);
result1 = sbiofit(modelObj, data, 'GaFrac = GaFracExpt', paramToEst, ...
    [], 'fminsearch', opt);
estValues1 = result1.ParameterEstimates
```

```
estValues1 =
```

```
1x3 table
```

Name	Estimate	StandardError
{'kGd'}	0.12142	0.0018548

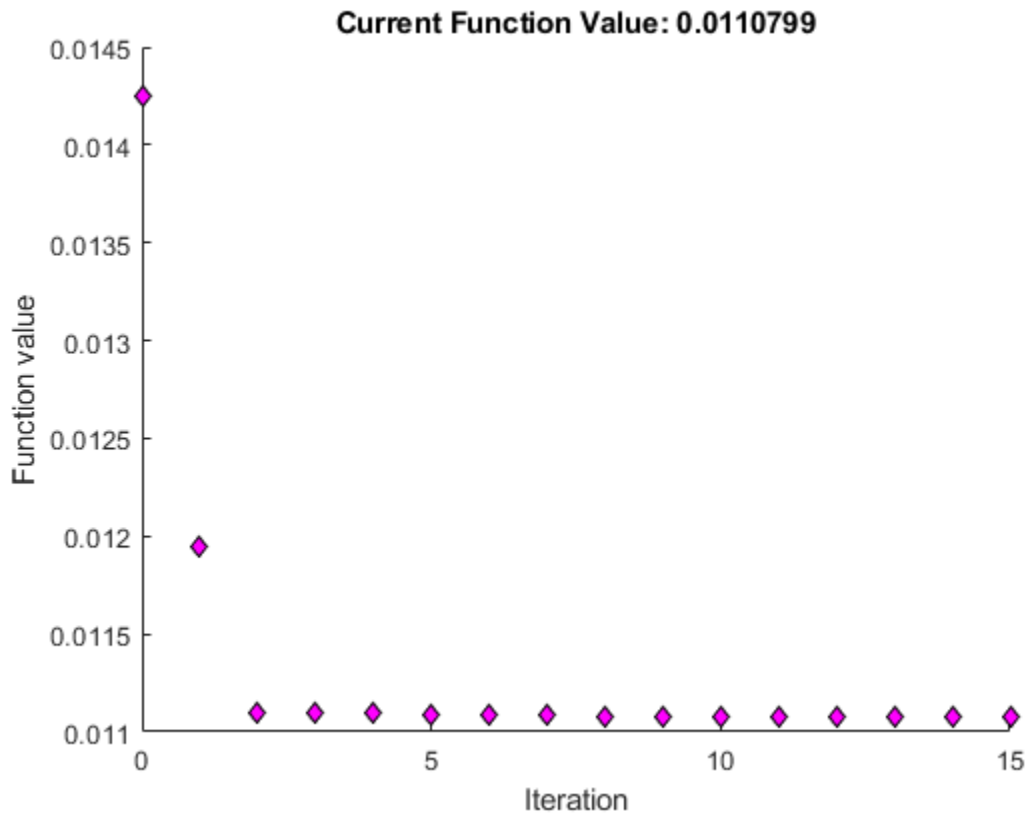

Store the estimated value of k_{Gd} in a new model Variant.

```
optimVariantObj = addvariant(modelObj, 'Optimized kGd');
addcontent(optimVariantObj, {'parameter', 'kGd', 'Value', estValues1.Estimate});
```

Activate the new variant and inactivate the 'mutant' variant.

```
optimVariantObj.Active = true;
mutantVariantObj = getvariant(modelObj, 'mutant');
mutantVariantObj.Active = false;
```

Simulate the model using the estimated value of k_{Gd} .

```
sdEst1 = sbiosimulate(modelObj);
```

Plot the data for $GaFrac$ and compare with the previous results.

```
[t1, GaFracEst1] = selectbyname(sdEst1, 'GaFrac');
sdEst1Resampled = resample(sdEst1, tExpt, 'pchip');
[~, GaFracEst1Resampled] = selectbyname(sdEst1Resampled, 'GaFrac');
sse1 = norm(GaFracExpt - GaFracEst1Resampled)^2;
rSquare1 = 1 - sse1/sst;
figure(fh);
plot(t1, GaFracEst1, 'm-');
legendText{end+1} = sprintf('kGd Changed, R^2 = %4.2f', rSquare1);
legend(legendText{:});
```

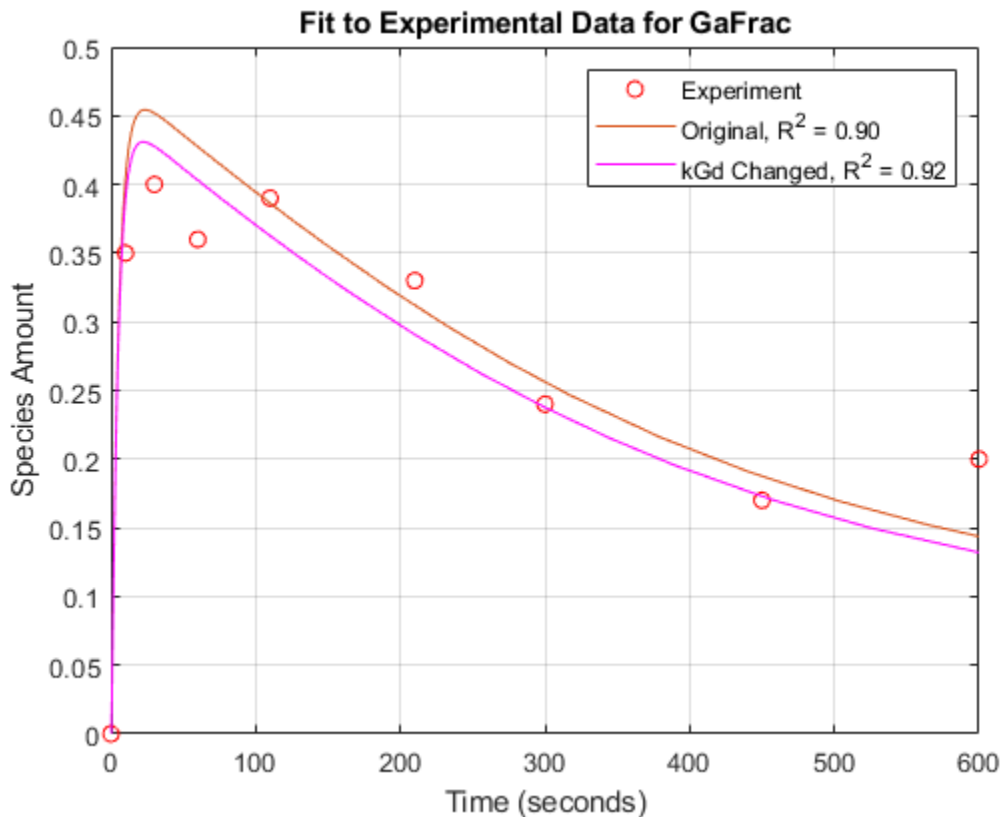

From the R-square values, we see that the fit to the experimental data is slightly better with the new, estimated value of k_{Gd} . If the original value for k_{Gd} was only a rough estimate, we could interpret these results either as a confirmation of the original estimate or an improvement over it.

Sensitivity Analysis - Background

So far we have been interested in the dynamic behavior of the active G protein, species Ga. A parameter scan revealed that this species is significantly affected by the value of the rate constant k_{Gd} governing G-protein inactivation. Using parameter estimation, we found that by optimizing the value of k_{Gd} , we were able to better fit an experimental timecourse for Ga.

A natural question to ask is, what other parameters of the model affect Ga levels, and what are the magnitudes of those effects? Sensitivity analysis allows you to answer these questions by computing the time-dependent derivatives of one or more species ("outputs") relative to either model parameter values, or species initial conditions ("input factors").

Sensitivity Analysis - Computing Sensitivities

Compute the sensitivity of Ga with respect to various parameters in the model. Normalize the sensitivities fully so they can be compared with each other.

Deactivate the mutant variant object on the model so that sensitivities are computed with k_{Gd} at its original value.

```
optimVariantObj.Active = false;
```

Set up the sensitivity calculation in the model configset.

```

% Turn on SensitivityAnalysis in the solver options.
configsetObj.SolverOptions.SensitivityAnalysis = true;

% Configure the sensitivity outputs and inputs for sensitivity analysis.
sensitivityOpt = configsetObj.SensitivityAnalysisOptions;
GaObj = sbioselect(modelObj, 'Type', 'species', 'Name', 'Ga');
sensitivityOpt.Outputs = GaObj;
params = sbioselect(modelObj, 'Type', 'parameter', 'Where', 'Name', '~=', 'GaFrac');
sensitivityOpt.Inputs = params;
sensitivityOpt.Normalization = 'Full';

```

Simulate the model.

```
sdSens = sbiosimulate(modelObj);
```

Extract the sensitivity data from the SimData object and plot the computed sensitivities.

```

[t, R, sensOutputs, sensInputs] = getsensmatrix(sdSens);
R = squeeze(R);

figure;
plot(t,R);
title('Normalized sensitivity of Ga with respect to various parameters');
xlabel('Time (seconds)');
ylabel('Sensitivity');
legend(sensInputs, 'Location', 'NorthEastOutside');
grid on;

```

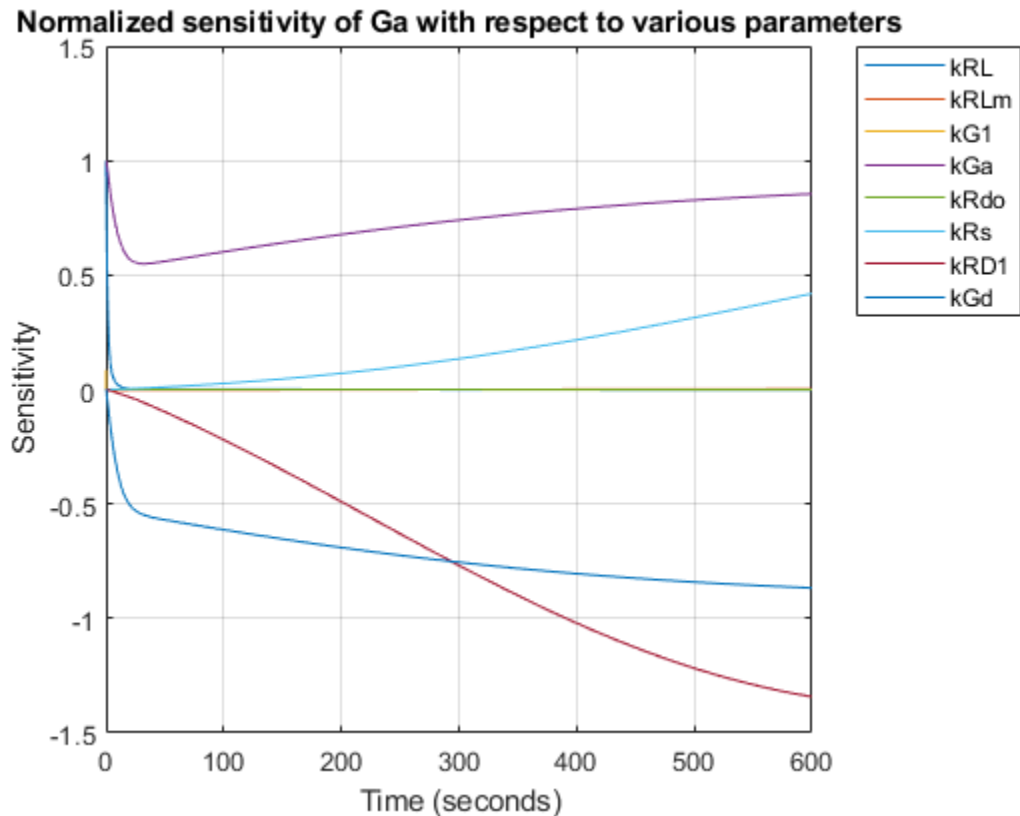

Parameter Estimation - Estimating Multiple Parameters

These results show that Ga is not only sensitive to the parameter kGd, but also to kGa, kRs, and kRD1. (The other sensitivities are indistinguishable from zero on the plot.) Varying these four parameters may make the fit to experimental data better still.

Estimate these four parameters to match the target data. Use the previously configured optimization options and the current parameter values in the model as the starting point for optimization.

Select the parameters kGa, kRs, kRD1, and kGd for estimation.

```
paramsToEst = estimatedInfo({'kGa', 'kRs', 'kRD1', 'kGd'});
```

Parameter estimation will ignore the sensitivity analysis option if it is enabled in the configset. Turn off SensitivityAnalysis in the solver options to avoid warnings.

```
configsetObj.SolverOptions.SensitivityAnalysis = false;
result2 = sbiofit(modelObj, data, 'GaFrac = GaFracExpt', paramsToEst, ...
    [], 'fminsearch', opt);
estValues2 = result2.ParameterEstimates
```

```
estValues2 =
```

```
4x3 table
```

Name	Estimate	StandardError
{'kGa' }	9.0068e-06	3.0249e-06
{'kRs' }	4.549	11.786
{'kRD1' }	0.0031018	0.0027417
{'kGd' }	0.12381	0.053702

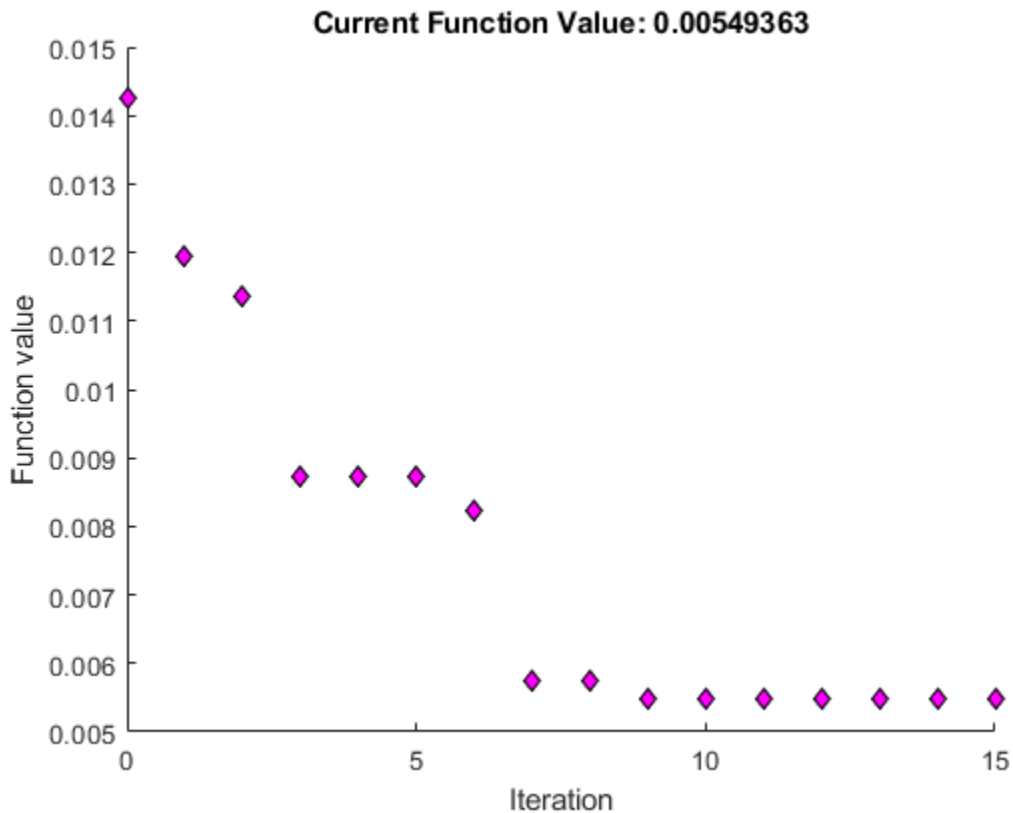

Store the estimated values of the four parameters in a new model variant.

```
optimVariantObj2 = addvariant(modelObj, 'Four parameter optimization');
addcontent(optimVariantObj2, {'parameter', 'kGa', 'Value', estValues2.Estimate(1)});
addcontent(optimVariantObj2, {'parameter', 'kRs', 'Value', estValues2.Estimate(2)});
addcontent(optimVariantObj2, {'parameter', 'kRD1', 'Value', estValues2.Estimate(3)});
addcontent(optimVariantObj2, {'parameter', 'kGd', 'Value', estValues2.Estimate(4)});
```

Now simulate the model with the newly estimated parameter values.

```
optimVariantObj.Active = false;
optimVariantObj2.Active = true;
sdEst2 = sbiosimulate(modelObj);
```

Compare with the previous results.

```
[t2, GaFracEst2] = selectbyname(sdEst2, 'GaFrac');
sdEst2Resampled = resample(sdEst2, tExpt, 'pchip');
[~, GaFracEst2Resampled] = selectbyname(sdEst2Resampled, 'GaFrac');
sse2 = norm(GaFracExpt - GaFracEst2Resampled)^2;
rSquare2 = 1 - sse2/sst;
figure(fh);
plot(t2, GaFracEst2, 'g-');
legendText{end+1} = sprintf('4 Constants Changed, R^2 = %4.2f', rSquare2);
legend(legendText{:});
```

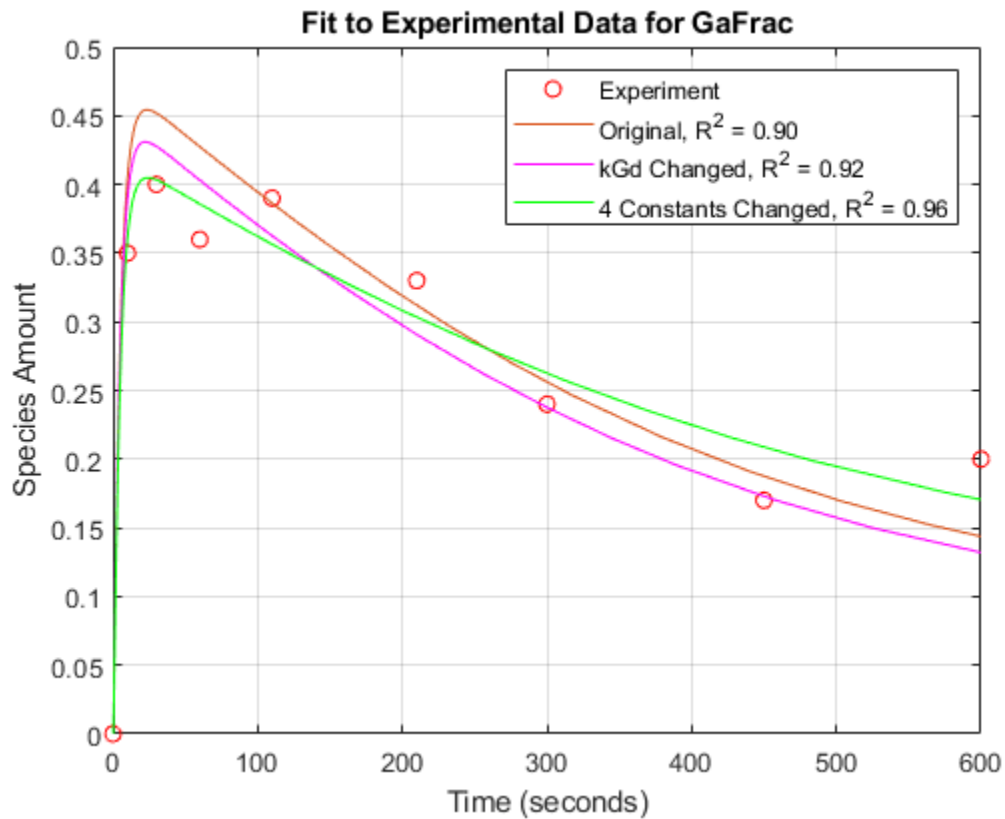

With parameter estimation free to vary four parameters, the fit to experimental data has improved further. The displayed optimization iterations show that the objective function has decreased and the R-square value has increased.

Note that the four-parameter estimation performed here may or may not be biologically relevant and is for illustrative purposes only.

Note also that storing the estimation results in variants makes it easy to switch back and forth between simulating different versions of the model. There are four versions at this point: the original, the mutant, and two versions based on the results of parameter estimations.

Conclusion

This example introduced various aspects of SimBiology functionality for model building, simulation, and analysis using a model of G protein signaling.

Finding Conserved Quantities in a Pathway Model

This example shows how to use the `sbioconsmoiety` function to find conserved quantities in a SimBiology® model.

Aims

- Use `sbioconsmoiety` to determine the conserved quantities present in two models of glycolysis in *T. brucei*.
- Use the computed conserved quantities in an analysis of these models.

Background

Trypanosoma brucei is the single-celled, eukaryotic parasite responsible for African sleeping sickness. This organism survives inside an infected host by metabolizing glucose from the host bloodstream. In *T. brucei* as well as other trypanosomes, a large portion of glycolysis occurs inside a specialized organelle called the glycosome.

To investigate the function of the glycosome, Bakker et al. (2000, 1997) constructed and validated a computational model of glycolysis in *T. brucei* that explicitly includes glycosomal compartmentation. They compared the properties of this model to those of a derived model in which the glycosome is absent. Among other results, they found that in the absence of the glycosome, hexose phosphate intermediates in the glycolytic pathway can accumulate to high levels that would be hazardous to the cell. In their analysis, Bakker et al. were able to explain how the compartmentation of metabolites provided by the glycosome prevents this potentially toxic accumulation.

One way to understand the effect of compartmentation is to examine how it affects the conserved quantities present in the system. In this example, we calculate the conserved quantities in the two models of *T. brucei* glycolysis and discuss their significance in the context of the analysis of Bakker et al.

Load the Project

Begin by loading the project at the command-line using `sbioloadproject`.

```
sbioloadproject trypanosome_glycolysis
```

The project contains two models. The first model, `m1`, contains the wild-type glycolysis network displayed below. (You can explore the network interactively by starting the SimBiology Model Builder app with `simBiologyModelBuilder` and opening the project file `trypanosome_glycolysis.sbproj` located in `(matlabroot/toolbox/simbio/simbiodemodemos)`.)

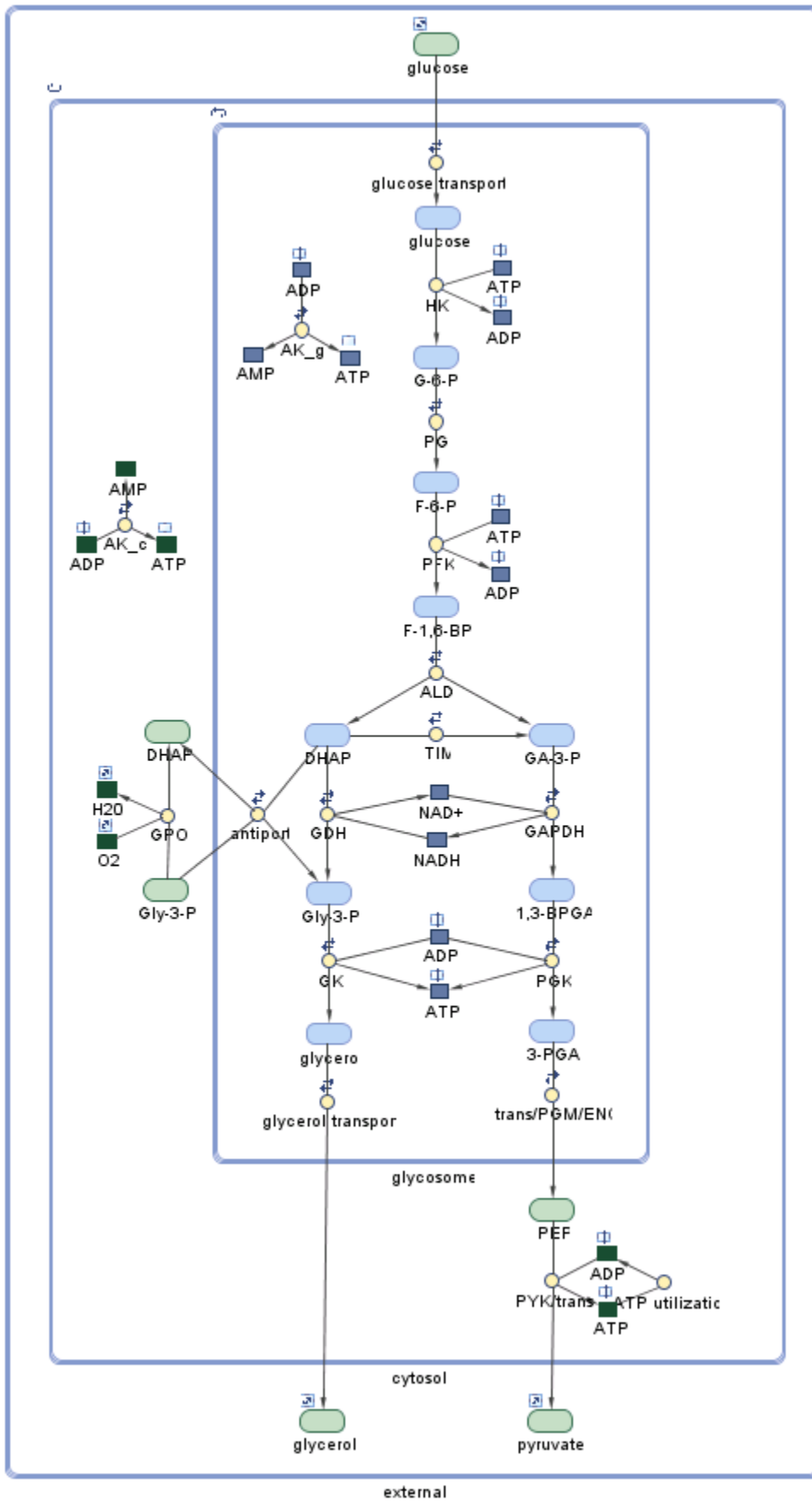

This system is a slightly simplified version of the pathway used by Bakker et al. The model has three compartments: glycosome, cytosol, and external. Metabolites contained in the glycosome are in blue, while metabolites in the cytosol or external to the cell are in green. Some species, such as glycerol 3-phosphate (Gly-3-P), are present in multiple compartments.

The pathway begins with the import of extracellular glucose into the glycosome (for convenience, the cytosol is "skipped" in this process). The pathway proceeds downwards in the diagram, ending with the transport of pyruvate out of the cytosol. Under aerobic conditions, glycerol 3-phosphate (Gly-3-P) is oxidized via glycerol-3-phosphate oxidase (GPO) outside the glycosome; as a consequence, glucose is fully converted to pyruvate. Under anaerobic conditions, this reaction does not occur and the glycolytic pathway produces glycerol in addition to pyruvate.

Compute the Conserved Quantities in the Wild-Type Network

The function `sbioconsmoiety` examines the structure of a model's stoichiometry matrix to find linear combinations of species that are conserved. This analysis is structural in that it relies only on the stoichiometry and structure of the network and not on reaction kinetics. In fact, all the reaction rates in this model have been set to 0 because these rates are not important to our analysis. Here we call `sbioconsmoiety` with the algorithm specification `'semipos'`, so that all conserved quantities returned involve only positive sums of species. The third argument `'p'` asks for the output to be printed to a cell array of strings.

```
cons_wt = sbioconsmoiety(m1,'semipos','p')

cons_wt = 10x1 cell
    {'external.glucose'
     'external.glycerol'
     'external.pyruvate'
     'cytosol.H2O'
     'cytosol.O2'
     'cytosol.Gly-3-P + cytosol.DHAP'
     'cytosol.ATP + cytosol.ADP + cytosol.AMP'
     'glycosome.ATP + glycosome.ADP + glycosome.AMP'
     'glycosome.NAD+ + glycosome.NADH'
     '2 glycosome.ATP + glycosome.ADP + glycosome.G-6-P + glycosome.F-6-P + 2 glycosome.F-1,6-BP
```

The last cell in the cell array contains a long string. Break this string up and display it so it can be read.

```
disp(cons_wt{end}(1:68));

2 glycosome.ATP + glycosome.ADP + glycosome.G-6-P + glycosome.F-6-P

disp(cons_wt{end}(69:147));

+ 2 glycosome.F-1,6-BP + glycosome.DHAP + glycosome.GA-3-P + glycosome.Gly-3-P

disp(cons_wt{end}(148:end));

+ glycosome.1,3-BPGA
```

The output of `sbioconsmoiety` contains ten quantities whose time rate of change is zero, regardless of reaction kinetics. There are two conserved pools of the adenine nucleotides ATP, ADP, and AMP, one in the glycosome and one in the cytosol. The glycosomal pool of nicotinamide nucleotides NAD⁺ and NADH is conserved as well. The singly conserved species such as `external.glucose` and `cytosol.O2` are species on the boundary of the system that have their `BoundaryCondition` property set to true. These

species are included in the output of `sbioconsmoiety` because their amounts would indeed remain constant during a hypothetical simulation.

The remaining two conserved quantities represent pools of bound phosphate, one inside and one outside the glycosome. The one inside includes nine different species. Note that the coefficients of ATP and fructose-1,6-biphosphate (F-1,6-BP) are both 2, as these species each have two transferable phosphate groups.

The species participating in the conserved sum have been highlighted below. This figure was generated by selecting the relevant species in the Diagram Table View in the SimBiology desktop. The conserved cycle "begins" when glucose is phosphorylated by ATP to form glucose 6-phosphate (G-6-P). This phosphate group propagates down through the pathway until it is transferred back to ATP from 1,3-biphosphoglycerate (1,3-BPGA) or glycosomal glycerol 3-phosphate (Gly-3-P), completing the cycle.

Note that the sum $\text{cytosol.DHAP} + \text{cytosol.Gly-3-P}$ arises as an independently conserved pool because the DHAP/Gly-3-P antiporter exchanges one glycosomal DHAP molecule for one cytosolic Gly-3-P molecule and vice versa. There are fluxes of phosphate groups in and out of this pool, but the net flux is zero because these fluxes cancel each other out.

View the Experimental Model with No Glycosome

Now let's consider the second model, *m2*, that contains the *in silico* experimental network of Bakker et al. in which the glycosome has been removed. In this model all metabolites reside in the cytosol. In particular, there is no longer an antiport exchange of DHAP and Gly-3-P in and out of the glycosome, and there is a single pool for the adenine nucleotides ATP, ADP, and AMP.

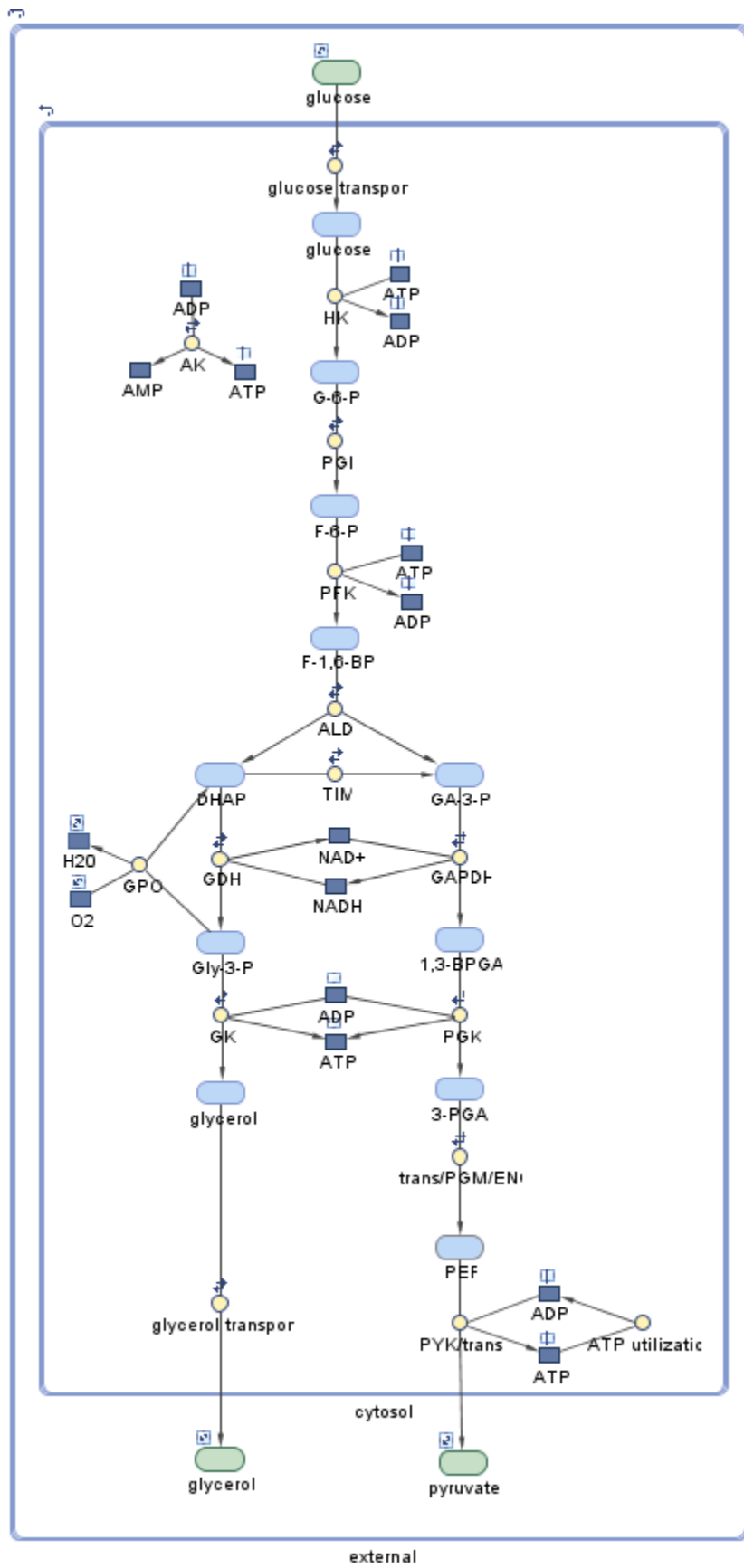

Compute the Conserved Quantities in the Experimental Network

```
cons_exp = sbioconsmoiety(m2,'semipos','p')

cons_exp = 7x1 cell
    {'external.glucose'           }
    {'external.glycerol'         }
    {'external.pyruvate'         }
    {'cytosol.H2O'               }
    {'cytosol.O2'                }
    {'cytosol.NADH + cytosol.NAD+' }
    {'cytosol.AMP + cytosol.ADP + cytosol.ATP' }
```

The species on the boundary of the system are still present in the experimental model, and their amounts are again conserved. Without the glycosome, however, the conservation of bound phosphates has disappeared, leaving only conservation relations for the nicotinamide and adenine nucleotides.

Discussion

In their analysis of the function of the glycosome in *T. brucei*, Bakker et al. find that glycosomal compartmentation prevents the potentially toxic accumulation of the hexose phosphate intermediates G-6-P and F-1,6-BP during glycolysis. This observation can be understood in light of the observed difference in the conservation of phosphates with and without the glycosome. When the glycosome is present, intermediates such as G-6-P or F-1,6-BP cannot accumulate to arbitrarily high levels, as they are limited by the total amount of organic phosphate present in a conserved pool. Without the glycosome, this restriction is absent. Insight may also be gained by considering the glycosomal compartmentation of adenine nucleotides. When the extracellular level of glucose is increased, the reactions HK and PFK are stimulated. When the glycosome is present, these reactions are self-limiting, as they deplete the ATP from a conserved pool of glycosomal ATP, ADP, and AMP. When the glycosome is absent, on the other hand, the cytosolic ATP/ADP ratio in fact increases with increasing levels of extracellular glucose. As a consequence, the reactions HK and PFK are further stimulated, leading to the accumulation of their products, G-6-P and F-1,6-BP.

This analysis shows that glycosomal compartmentation provides a negative feedback mechanism on the buildup of intermediates. Bakker et al. suggest that the conserved pool of organic phosphates may also serve as an energy storage mechanism for wild-type *T. brucei* during times of starvation.

In this example we have shown how to calculate the conserved quantities in a SimBiology model and how an analysis of these conserved quantities can lead to insight into the behavior of a network.

References

Bakker, B. M., Mensonides, F. I. C., Teusink, B., van Hoek, P., Michels, P. A. M., and Westerhoff, H. V. Compartmentation Protects Trypanosomes from the Dangerous Design of Glycolysis. *PNAS* (2000) vol. 97, 2087-2092.

Bakker, B. M., Michels, P. A. M., Opperdoes, F. R., and Westerhoff, H. V. Glycolysis in Bloodstream Form *Trypanosoma brucei* Can Be Understood in Terms of the Kinetics of the Glycolytic Enzymes. *J. Biol. Chem.* (1997) vol. 272, 3207-3215.

Modeling the Population Pharmacokinetics of Phenobarbital in Neonates

This example shows how to build a simple nonlinear mixed-effects model from clinical pharmacokinetic data.

Data were collected on 59 pre-term infants given phenobarbital for prevention of seizures during the first 16 days after birth. Each individual received an initial dose followed by one or more sustaining doses by intravenous bolus administration. A total of between 1 and 6 concentration measurements were obtained from each individual at times other than dose times, as part of routine monitoring, for a total of 155 measurements. Infant weights and APGAR scores (a measure of newborn health) were also recorded.

This example uses data described in [1], a study funded by NIH/NIBIB grant P41-EB01975.

This example requires Statistics and Machine Learning Toolbox™.

Load the Data

These data were downloaded from the website <http://depts.washington.edu/rfpk/> (no longer active) of the Resource Facility for Population Pharmacokinetics as a text file, and saved as a dataset array for ease of use.

```
load pheno.mat ds
```

Visualize the Data in a Trellis Plot

```
t = sbiotrellis(ds, 'ID', 'TIME', 'CONC', 'marker', 'o', ...  
               'markerfacecolor', [.7 .7 .7], 'markeredgecolor', 'r', ...  
               'linestyle', 'none');
```

```
% Format the plot.  
t.plottitle = 'States versus Time';
```

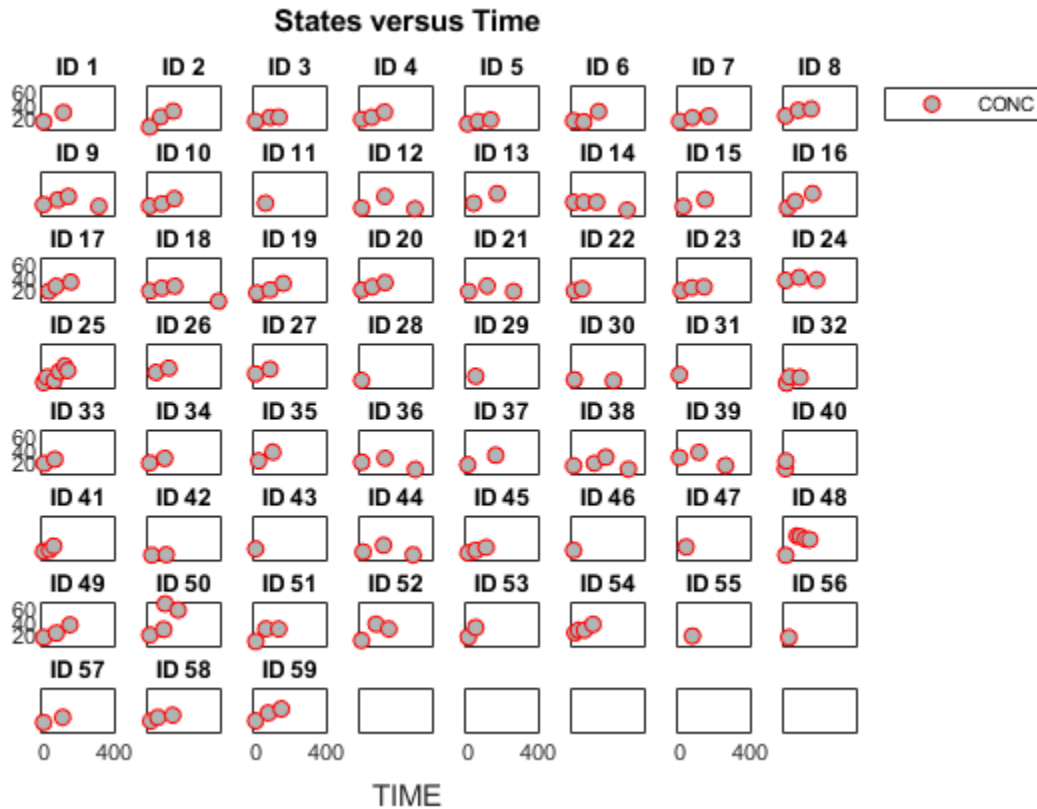

```
t.updateFigureForPrinting();
```

Describe the Data

In order to perform nonlinear mixed-effects modeling on this dataset, we need to convert the data to a `groupedData` object, a container for holding tabular data that is divided into groups. The `groupedData` constructor automatically identifies commonly use variable names as the grouping variable or the independent (time) variable. Display the properties of the data and confirm that `GroupVariableName` and `IndependentVariableName` are correctly identified as 'ID' and 'TIME', respectively.

```
data = groupedData(ds);
data.Properties
```

```
ans = struct with fields:
    Description: ''
    UserData: []
    DimensionNames: {'Observations' 'Variables'}
    VariableNames: {'ID' 'TIME' 'DOSE' 'WEIGHT' 'APGAR' 'CONC'}
    VariableDescriptions: {}
    VariableUnits: {}
    VariableContinuity: []
    RowNames: {}
    CustomProperties: [1x1 matlab.tabular.CustomProperties]
    GroupVariableName: 'ID'
    IndependentVariableName: 'TIME'
```

Define the Model

We will fit a simple one-compartment model, with bolus dose administration and linear clearance elimination, to the data.

```
pkmd = PKModelDesign;
pkmd.addCompartment('Central', 'DosingType', 'Bolus', 'EliminationType', ...
  'Linear-Clearance', 'HasResponseVariable', true);
model = pkmd.construct;

% The model species |Drug_Central| corresponds to the data variable |CONC|.
responseMap = 'Drug_Central = CONC';
```

Specify Initial Estimates for the Parameters

The parameters fit in this model are the volume of the central compartment (`Central`) and the clearance rate (`Cl_Central`). NLMEFIT calculates fixed and random effects for each parameter. The underlying algorithm assumes parameters are normally distributed. This assumption may not hold for biological parameters that are constrained to be positive, such as volume and clearance. We need to specify a transform for the estimated parameters, such that the transformed parameters do follow a normal distribution. By default, SimBiology® chooses a log transform for all estimated parameters. Therefore, the model is:

$$\log(V_i) = \log(\phi_{V,i}) = \theta_V + \eta_{V,i}$$

and

$$\log(Cl_i) = \log(\phi_{Cl,i}) = \theta_{Cl} + \eta_{Cl,i}$$

where θ , η , and ϕ are the fixed effects, random effects, and estimated parameter values respectively, calculated for each group i . We provide some arbitrary initial estimates for V and Cl in the absence of better empirical data.

```
estimatedParams = estimatedInfo({'log(Central)', 'log(Cl_Central)'}, ...
  'InitialValue', [1 1]);
```

Extract the Dosing Information from the Data

Create a sample dose that targets species `Drug_Central` and use the `createDoses` method to generate doses for each infant based on the dosing amount listed in variable `DOSE`.

```
sampleDose = sbiodose('sample', 'TargetName', 'Drug_Central');
doses = createDoses(data, 'DOSE', '', sampleDose);
```

Fit the Model

Slightly loosen the tolerances to speed up the fit.

```
fitOptions.Options = statset('TolFun', 1e-3, 'TolX', 1e-3);
[nlmeResults, simI, simP] = sbiofitmixed(model, data, responseMap, ...
  estimatedParams, doses, 'nlmefit', fitOptions);
```

Visualize the Fitted Model with the Data

Overlay the fitted simulation results on top of the observed data already displayed on the trellis plot. For the population results, simulations are run using the estimated fixed effects as the parameter

values. For the individual results, simulations are run using the sum of the fixed and random effects as the parameter values.

```
t.plot(simP, [], '', 'Drug_Central');
t.plot(simI, [], '', 'Drug_Central',...
      'Legend',{ 'Observed', 'Fit-Pop.', 'Fit-Indiv.'});
```

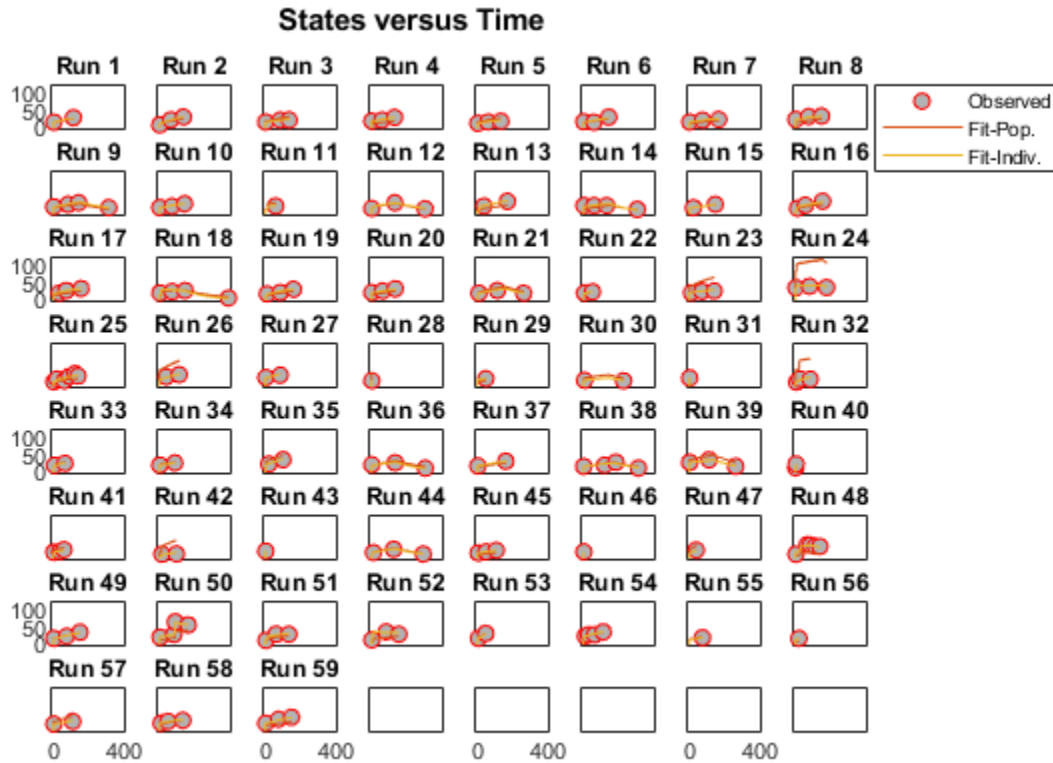

Examine Fitted Parameters and Covariances

```
disp('Summary of initial results');
Summary of initial results

disp('Parameter Estimates Without Random Effects:');
Parameter Estimates Without Random Effects:

disp(nlmeResults.PopulationParameterEstimates(1:2,:));
```

Group	Name	Estimate
1	{'Central' }	1.4086
1	{'Cl_Central'}	0.006137

```
disp('Estimated Fixed Effects:');
Estimated Fixed Effects:

disp(nlmeResults.FixedEffects);
```

Name	Description	Estimate	StandardError
{'theta1'}	{'Central' }	0.34257	0.061246
{'theta2'}	{'Cl_Central'}	-5.0934	0.079501

```
disp('Estimated Covariance Matrix of Random Effects:');
```

Estimated Covariance Matrix of Random Effects:

```
disp(nlmeResults.RandomEffectCovarianceMatrix);
```

	eta1	eta2
eta1	0.20323	0
eta2	0	0.19338

Generate a Box Plot of the Estimated Parameters

This example uses MATLAB® plotting commands to visualize the results. Several commonly used plots are also available as built-in options when performing parameter fits through the SimBiology® desktop interface.

```
% Create a box plot of the calculated random effects.
boxplot(nlmeResults);
```

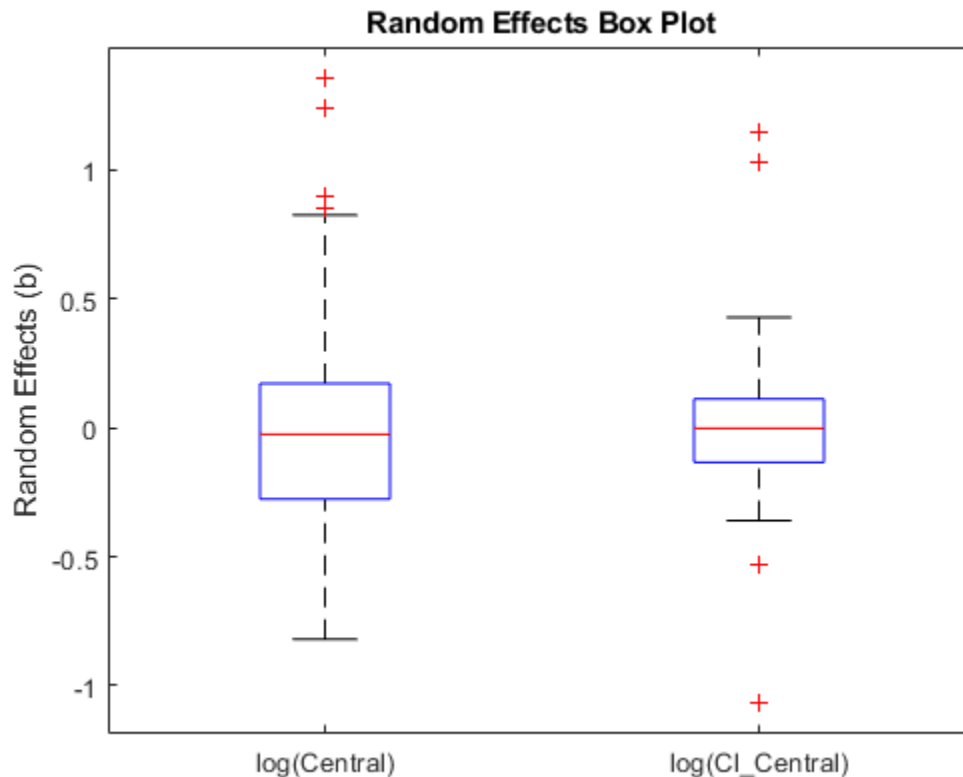

Generate a Plot of the Residuals over Time

```
% The vector of observation data also includes NaN's at the time points at
% which doses were given. We need to remove these NaN's to be able to plot
% the residuals over time.
timeVec = data.(data.Properties.IndependentVariableName);
obsData = data.CONC;
indicesToKeep = ~isnan(obsData);
timeVec = timeVec(indicesToKeep);

% Get the residuals from the fitting results.
indRes = nlmeResults.stats.ires(indicesToKeep);
popRes = nlmeResults.stats.pres(indicesToKeep);

% Plot the residuals. Get a handle to the plot to be able to add more data
% to it later.
resplot = figure;
plot(timeVec,indRes,'d','MarkerFaceColor','b','markerEdgeColor','b');
hold on;
plot(timeVec,popRes,'d','MarkerFaceColor','w','markerEdgeColor','b');
hold off;

% Create a reference line representing a zero residual, and set its
% properties to omit this line from the plot legend.
refl = refline(0,0);
refl.Annotation.LegendInformation.IconDisplayStyle = 'off';

% Label the plot.
title('Residuals versus Time');
xlabel('Time');
ylabel('Residuals');
legend({'Individual','Population'});
```

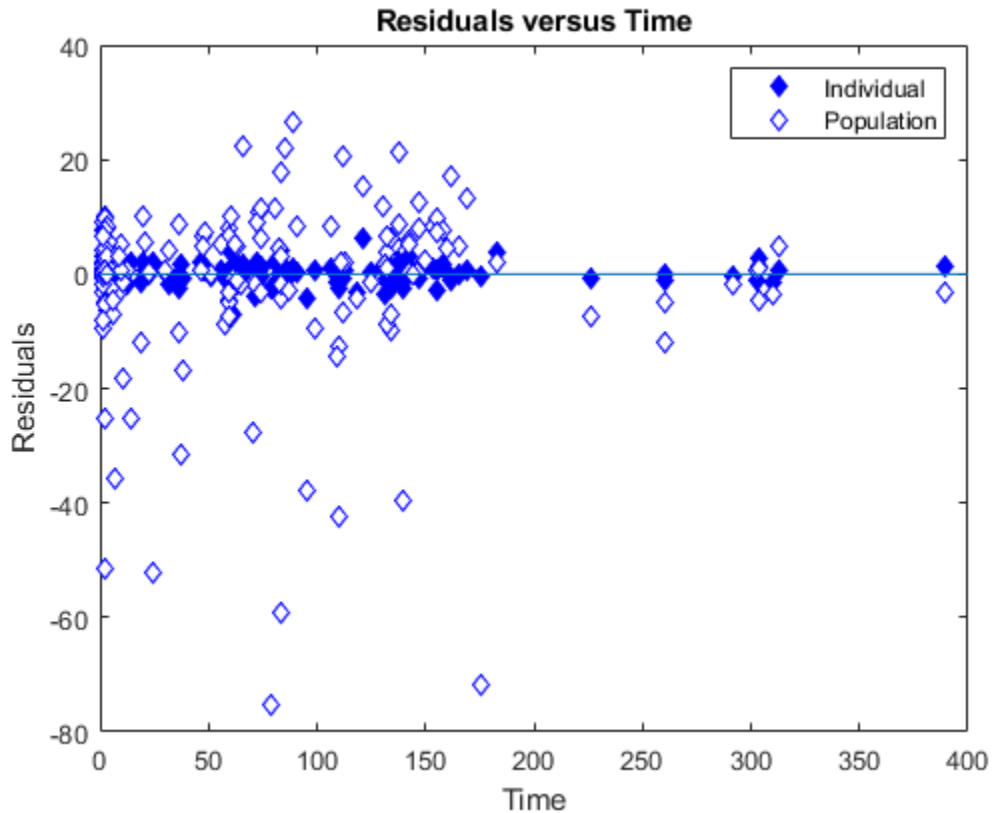

Extract Group-dependent Covariate Values from the Dataset

Get the mean value of each covariate for each group.

```
covariateLabels = {'WEIGHT', 'APGAR'};
covariates = grpstats(ds, data.Properties.GroupVariableName, 'mean', ...
    'DataVars', covariateLabels);
```

Examine NLME Parameter Fit Results for Possible Covariate Dependencies

```
% Get the parameter values for each group (empirical Bayes estimates).
paramValues = nlmeResults.IndividualParameterEstimates.Estimate;
isCentral = strcmp('Central', nlmeResults.IndividualParameterEstimates.Name);
isCl = strcmp('Cl_Central', nlmeResults.IndividualParameterEstimates.Name);
```

```
% Plot the parameter values vs. covariates for each group.
```

```
figure;
subplot(2,2,1);
plot(covariates.mean_WEIGHT, paramValues(isCentral), '.');
ylabel('Volume');

subplot(2,2,3);
plot(covariates.mean_WEIGHT, paramValues(isCl), '.');
ylabel('Clearance');
xlabel('weight');
```

```
subplot(2,2,2);
plot(covariates.mean_APGAR, paramValues(isCentral), '.');
```

```
subplot(2,2,4);
plot(covariates.mean_APGAR, paramValues(isCl), '.');
xlabel('APGAR');
```

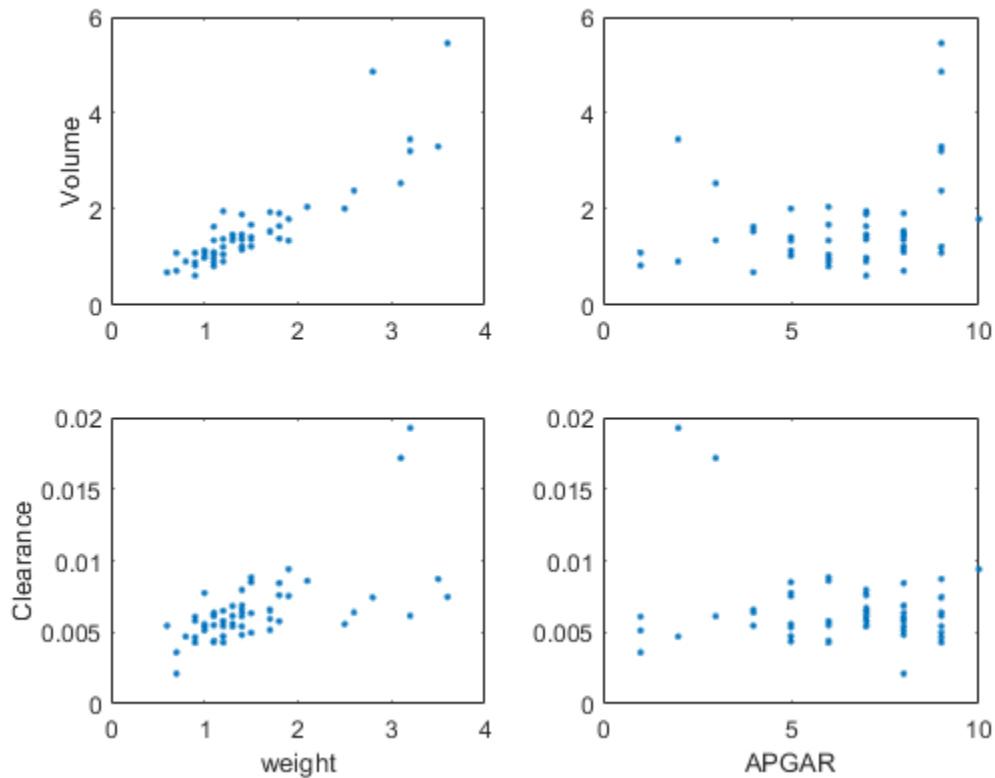

Create a CovariateModel to Model the Covariate Dependencies

Based on the plots, there appears to be a correlation between volume and weight, clearance and weight, and possibly volume and APGAR score. We choose to focus on the effect of weight by modeling two of these covariate dependencies: volume ("Central") varying with weight and clearance ("Cl_Central") varying with weight. Our model is:

$$\log(V_i) = \log(\phi_{V,i}) = \theta_V + \theta_{V/weight} * weight_i + \eta_{V,i}$$

and

$$\log(Cl_i) = \log(\phi_{Cl,i}) = \theta_{Cl} + \theta_{Cl/weight} * weight_i + \eta_{Cl,i}$$

```
% Define the covariate model.
```

```
covmodel = CovariateModel;
```

```
covmodel.Expression = ({'Central = exp(theta1 + theta2*WEIGHT + eta1)', 'Cl_Central = exp(theta3 +
```

```
% Use constructDefaultInitialEstimate to create a initialEstimates struct.
```

```
initialEstimates = covmodel.constructDefaultFixedEffectValues;
```

```
disp('Fixed Effects Description:');
```

```
Fixed Effects Description:
```

```
disp(covmodel.FixedEffectDescription);
```

```
    {'Central'          }
    {'Cl_Central'      }
    {'Central/WEIGHT'  }
    {'Cl_Central/WEIGHT'}
```

Update the initial estimates using the values estimated from fitting the base model.

```
initialEstimates.theta1 = nlmeResults.FixedEffects.Estimate(1);
initialEstimates.theta3 = nlmeResults.FixedEffects.Estimate(2);
covmodel.FixedEffectValues = initialEstimates;
```

Fit the Model

```
[nlmeResults_cov, simI_cov, simP_cov] = sbiofitmixed(model, data, responseMap, ...
    covmodel, doses, 'nlmefit', fitOptions);
```

Examine Fitted Parameters and Covariances

```
disp('Summary of results when modeling covariate dependencies');
```

Summary of results when modeling covariate dependencies

```
disp('Parameter Estimates Without Random Effects:');
```

Parameter Estimates Without Random Effects:

```
disp(nlmeResults_cov.PopulationParameterEstimates);
```

Group	Name	Estimate
1	{'Central' }	1.2973
1	{'Cl_Central' }	0.0061576
2	{'Central' }	1.3682
2	{'Cl_Central' }	0.0065512
3	{'Central' }	1.3682
3	{'Cl_Central' }	0.0065512
4	{'Central' }	0.99431
4	{'Cl_Central' }	0.0045173
5	{'Central' }	1.2973
5	{'Cl_Central' }	0.0061576
6	{'Central' }	1.1664
6	{'Cl_Central' }	0.00544
7	{'Central' }	1.0486
7	{'Cl_Central' }	0.004806
8	{'Central' }	1.1664
8	{'Cl_Central' }	0.00544
9	{'Central' }	1.2973
9	{'Cl_Central' }	0.0061576
10	{'Central' }	1.2973
10	{'Cl_Central' }	0.0061576
11	{'Central' }	1.1664
11	{'Cl_Central' }	0.00544
12	{'Central' }	1.2301
12	{'Cl_Central' }	0.0057877
13	{'Central' }	1.1059
13	{'Cl_Central' }	0.0051132
14	{'Central' }	1.1059

14	{'Cl_Central' }	0.0051132
15	{'Central' }	1.2301
15	{'Cl_Central' }	0.0057877
16	{'Central' }	1.1664
16	{'Cl_Central' }	0.00544
17	{'Central' }	1.1059
17	{'Cl_Central' }	0.0051132
18	{'Central' }	1.0486
18	{'Cl_Central' }	0.004806
19	{'Central' }	1.0486
19	{'Cl_Central' }	0.004806
20	{'Central' }	1.1664
20	{'Cl_Central' }	0.00544
21	{'Central' }	1.605
21	{'Cl_Central' }	0.0078894
22	{'Central' }	1.3682
22	{'Cl_Central' }	0.0065512
23	{'Central' }	3.2052
23	{'Cl_Central' }	0.017654
24	{'Central' }	3.3803
24	{'Cl_Central' }	0.018782
25	{'Central' }	0.89394
25	{'Cl_Central' }	0.0039908
26	{'Central' }	3.9653
26	{'Cl_Central' }	0.022619
27	{'Central' }	1.6927
27	{'Cl_Central' }	0.0083936
28	{'Central' }	3.3803
28	{'Cl_Central' }	0.018782
29	{'Central' }	1.0486
29	{'Cl_Central' }	0.004806
30	{'Central' }	1.605
30	{'Cl_Central' }	0.0078894
31	{'Central' }	1.2973
31	{'Cl_Central' }	0.0061576
32	{'Central' }	4.1819
32	{'Cl_Central' }	0.024064
33	{'Central' }	1.5218
33	{'Cl_Central' }	0.0074154
34	{'Central' }	1.5218
34	{'Cl_Central' }	0.0074154
35	{'Central' }	2.3292
35	{'Cl_Central' }	0.012173
36	{'Central' }	1.3682
36	{'Cl_Central' }	0.0065512
37	{'Central' }	1.1664
37	{'Cl_Central' }	0.00544
38	{'Central' }	1.2301
38	{'Cl_Central' }	0.0057877
39	{'Central' }	1.6927
39	{'Cl_Central' }	0.0083936
40	{'Central' }	1.1059
40	{'Cl_Central' }	0.0051132
41	{'Central' }	1.5218
41	{'Cl_Central' }	0.0074154
42	{'Central' }	2.7323
42	{'Cl_Central' }	0.014659
43	{'Central' }	0.99431

```

43      {'Cl_Central'}      0.0045173
44      {'Central'      }      1.2973
44      {'Cl_Central'}      0.0061576
45      {'Central'      }      0.94279
45      {'Cl_Central'}      0.0042459
46      {'Central'      }      1.1059
46      {'Cl_Central'}      0.0051132
47      {'Central'      }      2.4565
47      {'Cl_Central'}      0.012951
48      {'Central'      }      0.89394
48      {'Cl_Central'}      0.0039908
49      {'Central'      }      1.2301
49      {'Cl_Central'}      0.0057877
50      {'Central'      }      1.1059
50      {'Cl_Central'}      0.0051132
51      {'Central'      }      0.99431
51      {'Cl_Central'}      0.0045173
52      {'Central'      }      0.99431
52      {'Cl_Central'}      0.0045173
53      {'Central'      }      1.5218
53      {'Cl_Central'}      0.0074154
54      {'Central'      }      1.605
54      {'Cl_Central'}      0.0078894
55      {'Central'      }      1.1059
55      {'Cl_Central'}      0.0051132
56      {'Central'      }      0.84763
56      {'Cl_Central'}      0.003751
57      {'Central'      }      1.8827
57      {'Cl_Central'}      0.0095009
58      {'Central'      }      1.2973
58      {'Cl_Central'}      0.0061576
59      {'Central'      }      1.1059
59      {'Cl_Central'}      0.0051132

```

```
disp('Estimated Fixed Effects:');
```

Estimated Fixed Effects:

```
disp(nlmeResults_cov.FixedEffects);
```

Name	Description	Estimate	StandardError
{'theta1'}	{'Central' }	-0.48453	0.067952
{'theta3'}	{'Cl_Central' }	-5.9575	0.12199
{'theta2'}	{'Central/WEIGHT' }	0.53203	0.040788
{'theta4'}	{'Cl_Central/WEIGHT' }	0.61957	0.074264

```
disp('Estimated Covariance Matrix:');
```

Estimated Covariance Matrix:

```
disp(nlmeResults_cov.RandomEffectCovarianceMatrix);
```

	eta1	eta2
eta1	0.029793	0
eta2	0	0.04644

Visualize the Fitted Model with the Data

```
t.plot(simP_cov, [], '', 'Drug_Central');
t.plot(simI_cov, [], '', 'Drug_Central',...
      'legend',{ 'Observed', 'Fit-Pop.', 'Fit-Indiv.', 'Cov. Fit-Pop.', 'Cov. Fit-Indiv.'});
```

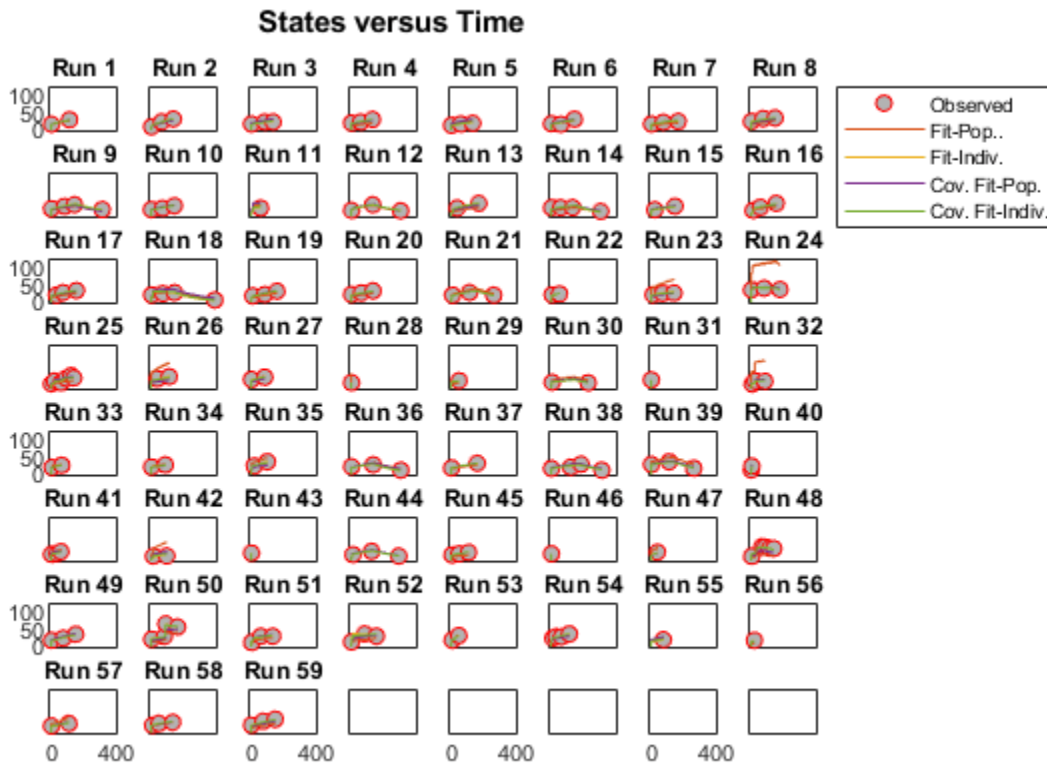

Compare the Residuals to Those from a Model Without Covariate Dependencies

The following plot shows that the population residuals are smaller in the covariate model fit compared to the original fit.

```
% Get the residuals from the fitting results.
indRes = nlmeResults_cov.stats.i-res(indicesToKeep);
popRes = nlmeResults_cov.stats.p-res(indicesToKeep);

% Return to the original residual plot figure and add the new data.
figure(resplot);
hold on;
plot(timeVec, indRes, 'd', 'MarkerFaceColor', 'r', 'markerEdgeColor', 'r');
plot(timeVec, popRes, 'd', 'MarkerFaceColor', 'w', 'markerEdgeColor', 'r');
hold off;

% Update the legend.
legend('off');
legend({'Individual', 'Population', 'Individual(Cov.)', 'Population(Cov.)'});
```

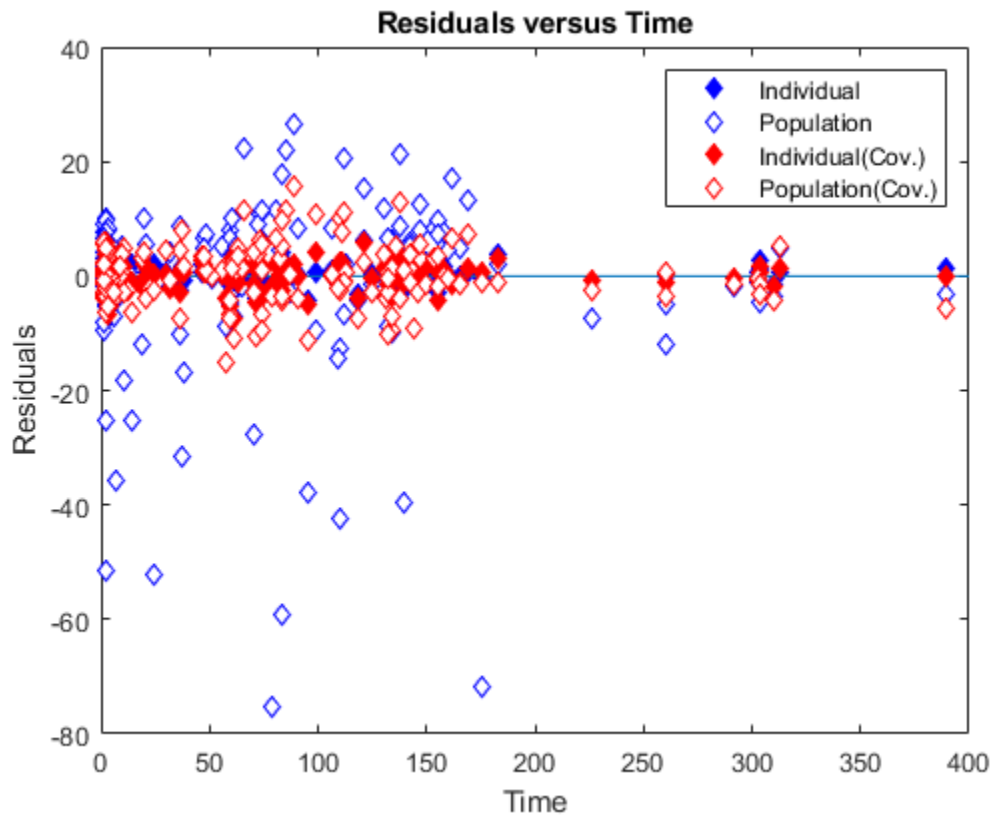
References

- [1] Grasela TH Jr, Donn SM. Neonatal population pharmacokinetics of phenobarbital derived from routine clinical data. *Dev Pharmacol Ther* 1985;8(6). 374-83.

Simulating the Glucose-Insulin Response

This example shows how to simulate and analyze a model in SimBiology® using a physiologically based model of the glucose-insulin system in normal and diabetic humans.

This example requires Statistics and Machine Learning Toolbox™ and Optimization Toolbox™.

References

- 1 Meal Simulation Model of the Glucose-Insulin System. C. Dalla Man, R.A. Rizza, and C. Cobelli. *IEEE Transactions on Biomedical Engineering* (2007) 54(10), 1740-1749.
- 2 A System Model of Oral Glucose Absorption: Validation on Gold Standard Data. C. Dalla Man, M. Camilleri, and C. Cobelli. *IEEE Transactions on Biomedical Engineering* (2006) 53(12), 2472-2478.

Aims

- Implement a SimBiology model of the glucose-insulin response.
- Simulate the glucose-insulin response to one or more meals for normal and impaired (diabetic) subjects.
- Perform parameter estimation using `sbiofit` with a forcing function strategy.

Background

In their 2007 publication, Dalla Man et al. develop a model for the human glucose-insulin response after a meal. This model describes the dynamics of the system using ordinary differential equations. The authors used their model to simulate the glucose-insulin response after one or more meals, for normal human subjects and for human subjects with various kinds of insulin impairments. The impairments were represented as alternate sets of parameter values and initial conditions.

We implemented the SimBiology model, `m1`, by:

- Translating the model equations in Dalla Man et al. (2007) into reactions, rules, and events.
- Organizing the model into two compartments, one for glucose-related species and reactions (named `Glucose appearance`) and one for insulin-related species and reactions (named `Insulin secretion`).
- Using the parameter values and initial conditions from the model equations and from Table 1 and Figure 1.
- Including an equation for the gastric emptying rate as presented in Dalla Man et al. (2006).
- Setting the units for all species, compartments, and parameters as specified by Dalla Man et al. (2007), which allows the SimBiology model to be simulated using unit conversion. (Note that SimBiology also supports the use of dimensionless parameters by setting their `ValueUnits` property to `dimensionless`.)
- Setting the configuration set `TimeUnits` to `hour`, since simulations were conducted over 7 or 24 hours.
- Using a basis of 1 kilogram of body weight to transform species and parameters that were normalized by body weight in the original model. Doing so made species units in amount or concentration, as required by SimBiology.

We represented the insulin impairments in the SimBiology model as variant objects with the following names:

- Type 2 diabetic
- Low insulin sensitivity
- High beta cell responsivity
- Low beta cell responsivity
- High insulin sensitivity

We represented the meals in the SimBiology model as dose objects:

- A dose named `Single Meal` represents a single meal of 78 grams of glucose at the start of a simulation.
- A dose named `Daily Life` represents one day's worth of meals, relative to a simulation starting at midnight: breakfast is 45 grams of glucose at 8 hours of simulation time (8 a.m.), lunch is 70 grams of glucose at 12 hours (noon), and dinner is 70 grams of glucose at 20 hours (8 p.m.).

A diagram of the SimBiology model is shown below:

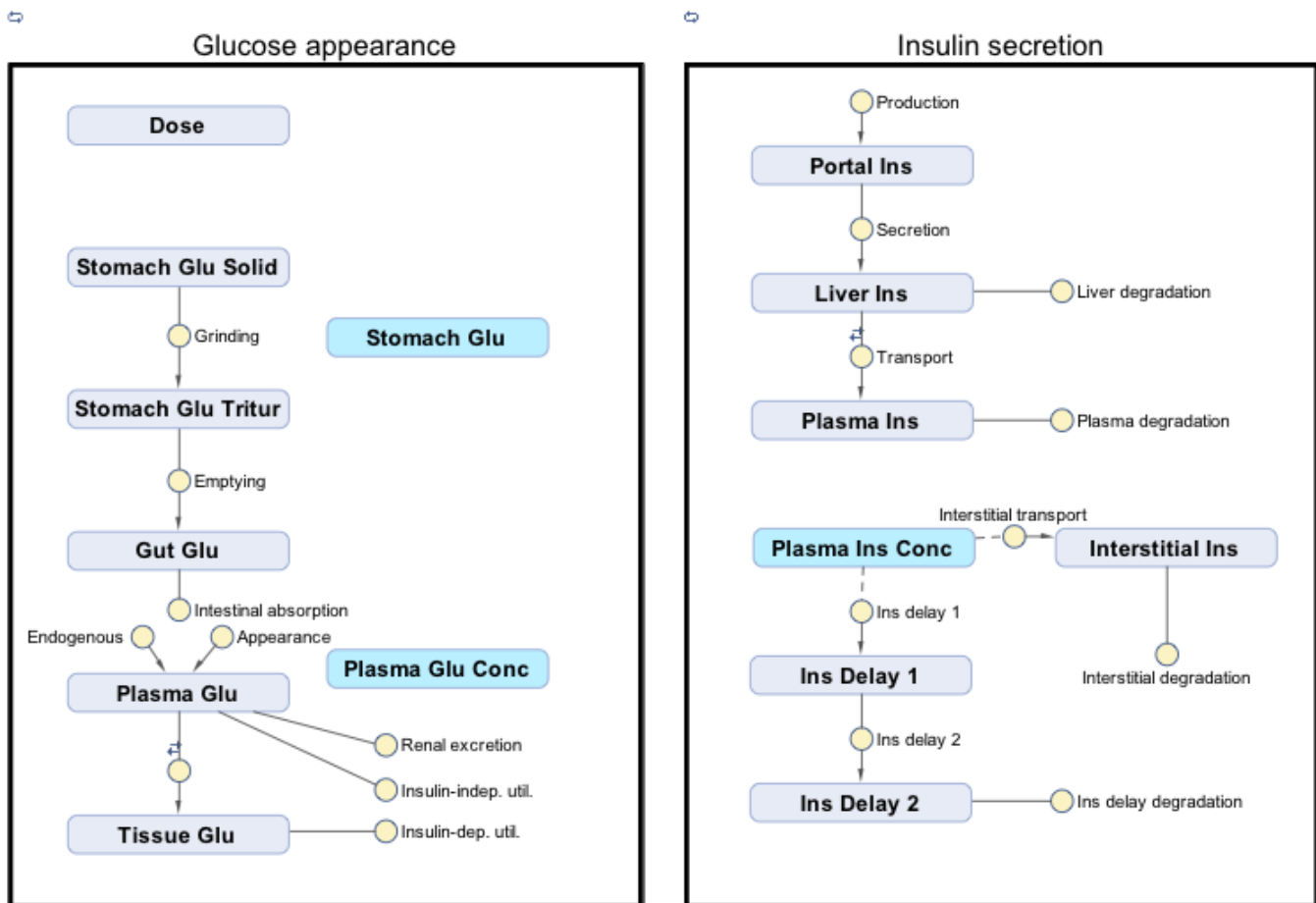

Setup

Load the model.

```
sbioloadproject('insulindemo', 'm1')
```

Suppress an informational warning that is issued during simulations.

```
warnSettings = warning('off', 'SimBiology:DimAnalysisNotDone_MatlabFcn_Dimensionless');
```

Simulating the Glucose-Insulin Response for a Normal Subject

Select the Single Meal dose object and display its properties.

```
mealDose = sbioselect(m1, 'Name', 'Single Meal');  
get(mealDose)
```

```
ans = struct with fields:  
    Amount: 78  
    Interval: 0  
    Rate: 0  
    RepeatCount: 0  
    StartTime: 0  
    Active: 0  
    AmountUnits: 'gram'  
    DurationParameterName: ''  
    EventMode: 'stop'  
    LagParameterName: ''  
    RateUnits: ''  
    TargetName: 'Dose'  
    TimeUnits: 'hour'  
    Name: 'Single Meal'  
    Parent: [1x1 SimBiology.Model]  
    Notes: ''  
    Tag: ''  
    Type: 'repeatdose'  
    UserData: []
```

Simulate for 7 hours.

```
configset = getconfigset(m1, 'active');  
configset.StopTime = 7;
```

Display the simulation time units (and StopTime units).

```
configset.TimeUnits
```

```
ans =  
'hour'
```

Simulate a single meal for a normal subject.

```
normalMealSim = sbiosimulate(m1, configset, [], mealDose);
```

Simulating the Glucose-Insulin Response for a Type 2 Diabetic

Select the Type 2 diabetic variant and display its properties.

```
diabeticVar = sbioselect(m1, 'Name', 'Type 2 diabetic')
```

```
diabeticVar =  
    SimBiology Variant - Type 2 diabetic (inactive)
```

ContentIndex:	Type:	Name:	Property:	Value:
---------------	-------	-------	-----------	--------

1	parameter	Plasma Volume ...	Value	1.49
2	parameter	k1	Value	0.042
3	parameter	k2	Value	0.071
4	parameter	Plasma Volume ...	Value	0.04
5	parameter	m1	Value	0.379
6	parameter	m2	Value	0.673
7	parameter	m4	Value	0.269
8	parameter	m5	Value	0.0526
9	parameter	m6	Value	0.8118
10	parameter	Hepatic Extrac...	Value	0.6
11	parameter	kmax	Value	0.0465
12	parameter	kmin	Value	0.0076
13	parameter	kabs	Value	0.023
14	parameter	kgri	Value	0.0465
15	parameter	f	Value	0.9
16	parameter	a	Value	6e-05
17	parameter	b	Value	0.68
18	parameter	c	Value	0.00023
19	parameter	d	Value	0.09
20	parameter	kp1	Value	3.09
21	parameter	kp2	Value	0.0007
22	parameter	kp3	Value	0.005
23	parameter	kp4	Value	0.0786
24	parameter	ki	Value	0.0066
25	parameter	[Ins Ind Glu U...	Value	1
26	parameter	Vm0	Value	4.65
27	parameter	Vmx	Value	0.034
28	parameter	Km	Value	466.21
29	parameter	p2U	Value	0.084
30	parameter	K	Value	0.99
31	parameter	alpha	Value	0.013
32	parameter	beta	Value	0.05
33	parameter	gamma	Value	0.5
34	parameter	ke1	Value	0.0007
35	parameter	ke2	Value	269
36	parameter	Basal Plasma G...	Value	164.18
37	parameter	Basal Plasma I...	Value	54.81

Simulate a single meal for a Type 2 diabetic.

```
diabeticMealSim = sbiosimulate(m1, configset, diabeticVar, mealDose);
```

Compare the results for the most important outputs of the simulation.

- Plasma Glucose (species Plasma Glu Conc)
- Plasma Insulin (species Plasma Ins Conc)
- Endogenous Glucose Production (parameter Glu Prod)
- Glucose Rate of Appearance (parameter Glu Appear Rate)
- Glucose Utilization (parameter Glu Util)
- Insulin Secretion (parameter Ins Secr)

```
outputNames = {'Plasma Glu Conc', 'Plasma Ins Conc', 'Glu Prod', ...
    'Glu Appear Rate', 'Glu Util', 'Ins Secr'};
figure;
for i = 1:numel(outputNames)
```

```

subplot(2, 3, i);

[tNormal, yNormal ] = normalMealSim.selectbyname(outputNames{i});
[tDiabetic, yDiabetic] = diabeticMealSim.selectbyname(outputNames{i});

plot( tNormal      , yNormal      , '-'      , ...
      tDiabetic    , yDiabetic    , '- -'    );

% Annotate figures
outputParam = sbioselect(m1, 'Name', outputNames{i});
title(outputNames{i});
xlabel('time (hour)');
if strcmp(outputParam.Type, 'parameter')
    ylabel(outputParam.ValueUnits);
else
    ylabel(outputParam.InitialAmountUnits);
end
xlim([0 7]);

% Add legend
if i == 3
    legend({'Normal', 'Diabetic'}, 'Location', 'Best');
end

end

```

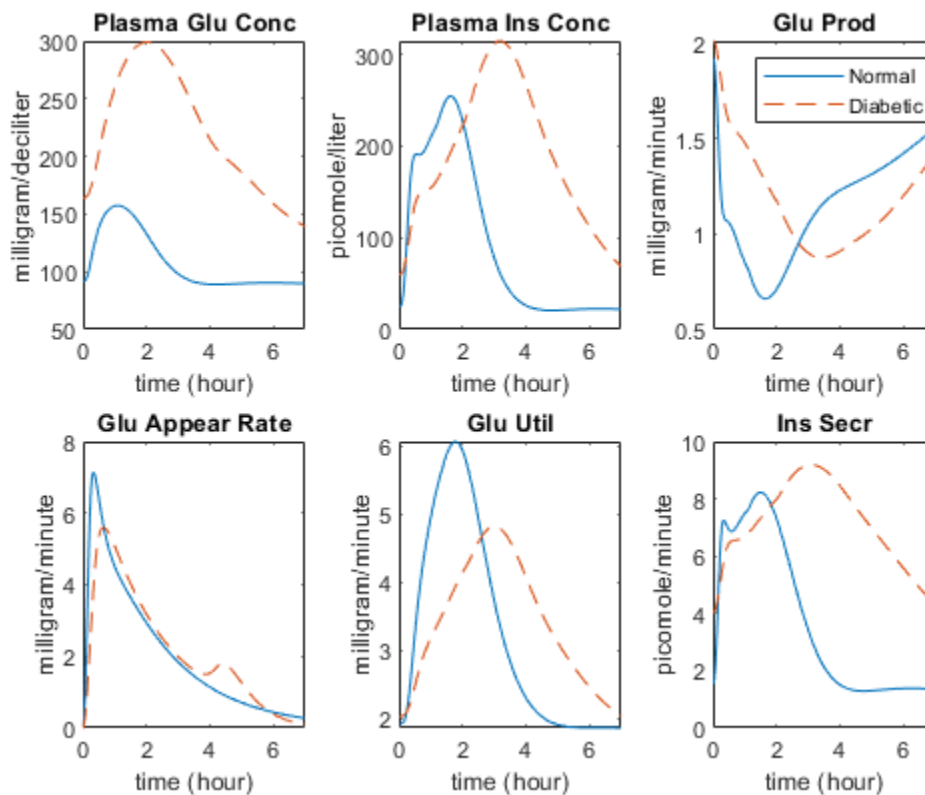

Note the much higher concentrations of glucose and insulin in the plasma, as well as the prolonged duration of glucose utilization and insulin secretion.

Simulating One Day with Three Meals for a Normal Subject

Set the simulation StopTime to 24 hours.

```
configset.StopTime = 24;
```

Select daily meal dose.

```
dayDose = sbioselect(m1, 'Name', 'Daily Life');
```

Simulate three meals for a normal subject.

```
normalDaySim = sbiosimulate(m1, configset, [], dayDose);
```

Simulating One Day with Three Meals for Impaired Subjects

Simulate the following combinations of impairments:

- Impairment 1: Low insulin sensitivity
- Impairment 2: Impairment 1 with high beta cell responsivity
- Impairment 3: Low beta cell responsivity
- Impairment 4: Impairment 3 with high insulin sensitivity

Store the impairments in a cell array.

```
impairVars{1} = sbioselect(m1, 'Name', 'Low insulin sensitivity' );
impairVars{2} = [impairVars{1}, ...
    sbioselect(m1, 'Name', 'High beta cell responsivity')];
impairVars{3} = sbioselect(m1, 'Name', 'Low beta cell responsivity' );
impairVars{4} = [impairVars{3}, ...
    sbioselect(m1, 'Name', 'High insulin sensitivity' )];
```

Simulate each impairment.

```
for i = 1:4
    impairSims(i) = sbiosimulate(m1, configset, impairVars{i}, dayDose);
end
```

Compare the plasma glucose and plasma insulin results.

```
figure;
outputNames = {'Plasma Glu Conc', 'Plasma Ins Conc'};

legendLabels = {'Normal'}, ...
    {'-Ins =\beta', '-Ins +\beta'}, ...
    {'=Ins -\beta', '+Ins -\beta'};
yLimits = [80 240; 0 500];
```

```
for i = 1:numel(outputNames)

    [tNormal, yNormal] = selectbyname(normalDaySim , outputNames{i} );
    [tImpair, yImpair] = selectbyname(impairSims , outputNames{i} );

    % Plot Normal
```

```

subplot(2, 3, 3*i-2 );
plot(tNormal, yNormal, 'b-');
xlim([0 24]);
ylim(yLimits(i,:));
xlabel('time (hour)');
legend(legendLabels{1}, 'Location', 'NorthWest');

% Plot Low Insulin
subplot(2, 3, 3*i-1 );
plot(tImpair{1}, yImpair{1}, 'g--', tImpair{2}, yImpair{2}, 'r:');
xlim([0 24]);
ylim(yLimits(i,:));
xlabel('time (hour)');
legend(legendLabels{2}, 'Location', 'NorthWest');
title(outputNames{i});

% Plot Low Beta
subplot(2, 3, 3*i );
plot(tImpair{3}, yImpair{3}, 'c-.', tImpair{4}, yImpair{4}, 'm-');
xlim([0 24]);
ylim(yLimits(i,:));
xlabel('time (hour)');
legend(legendLabels{3}, 'Location', 'NorthWest');

```

end

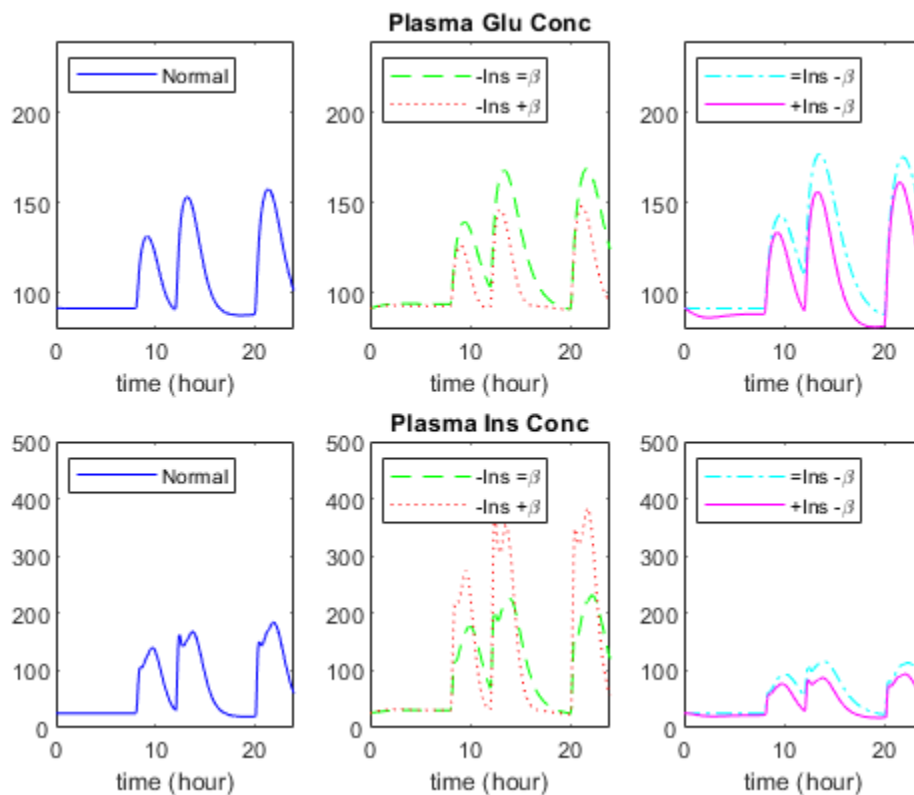

Note that either low insulin sensitivity (dashed green line, $-Ins = \beta$) or low beta-cell sensitivity (dashed-dotted cyan line, $= Ins - \beta$) lead to increased and prolonged plasma glucose concentrations (top row of plots). Low sensitivity in one system can be partially compensated by high sensitivity in another system. For example, low insulin sensitivity and high beta-cell sensitivity (dotted red line, $-Ins + \beta$) results in relatively normal plasma glucose concentrations (top row of plots). However, in this case, the resulting plasma insulin concentration is extremely high (bottom row of plots).

Parameter Estimation Methodology

Rather than simultaneously estimating parameters for the entire model, the authors perform parameter estimation for different subsystems of the model using a forcing function strategy. This approach requires additional experimental data for the "inputs" of the submodel. During fitting, the input data determine the dynamics of the inputs species. (In the full model, the dynamics of the inputs are determined from the differential equations.) In SimBiology terms, you can implement a forcing function as a repeated assignment rule that controls the value of a species or parameter that serves as an input for a subsystem of the model. In the following sections, we use the parameter fitting capabilities of SimBiology to refine the authors' reported parameter values.

Fitting the Gastrointestinal Model of Glucose Appearance Using `nlinfit`

The gastrointestinal model represents how glucose in a meal is transported through the stomach, gut, and intestine, and then absorbed into the plasma. The input to this subsystem is the amount of glucose in a meal, and the output is the rate of appearance of glucose in the plasma. However, we also estimate the meal size since the value reported by the authors is inconsistent with the parameters and simulation results. Because this input only occurs at the start of the simulation, no forcing function is required.

The function `sbiofit` supports the estimation of parameters in SimBiology models using several different algorithms from MATLAB™, Statistics and Machine Learning Toolbox, Optimization Toolbox, and Global Optimization Toolbox. First, estimate the parameters using Statistics and Machine Learning Toolbox function `nlinfit`.

```
% Load the experimental data
fitData = groupedData(readtable('GlucoseData.csv', 'Delimiter', ','));

% Set the units on the data
fitData.Properties.VariableUnits = {...
    'hour', ...           % Time units
    'milligram/minute', ... % GluRate units
    'milligram/deciliter', ... % PlasmaGluConc units
    'milligram/minute', ... % GluUtil units
};

% Identify which model components corresponds to observed data variables.
gastroFitObs = '[Glu Appear Rate] = GluRate';

% Estimate the value of the following parameters:
gastroFitEst = estimatedInfo({'kmax', 'kmin', 'kabs', 'Dose'});

% Ensure the parameter estimates are always positive during estimation by
% using a log transform on all parameters.
[gastroFitEst.Transform] = deal('log');

% Set the initial estimate for Dose to the reported meal dose amount. The
% remaining initial estimates will be taken from the parameter values in
% the model.
```

```

gastroFitEst(4).InitialValue = mealDose.Amount;

% Generate simulation data with the initial parameter estimates
configset.StopTime = 7;
gastroInitSim = sbiosimulate(m1, mealDose);

% Fit the data using [nlinfit], displaying output at each iteration
fitOptions = statset('Display', 'iter');
[gastroFitResults, gastroFitSims] = sbiofit(m1, fitData, ...
    gastroFitObs, gastroFitEst, [], 'nlinfit', fitOptions);

```

Iteration	SSE	Norm of Gradient	Norm of Step
0	43.798		
1	2.23537	22.9971	0.596828
2	1.65217	1.33015	0.107431
3	1.6491	0.0778306	0.0239131
4	1.64909	0.000589276	0.00225236
5	1.64908	2.50592e-05	4.70209e-05
6	1.64908	0.0882335	0.000107703
7	1.64908	0.0589321	6.47376e-10

Iterations terminated: relative norm of the current step is less than OPTIONS.TolX

Fitting the Data Using `fminunc`

Now, estimate the parameters using the Optimization Toolbox function `fminunc`.

```

% Fit the data, plotting the objective function at each iteration
fitOptions2 = optimoptions('fminunc', 'PlotFcns', @optimplotfval);
[gastroFitResults(2), gastroFitSims(2)] = sbiofit(m1, fitData, ...
    gastroFitObs, gastroFitEst, [], 'fminunc', fitOptions2);

```

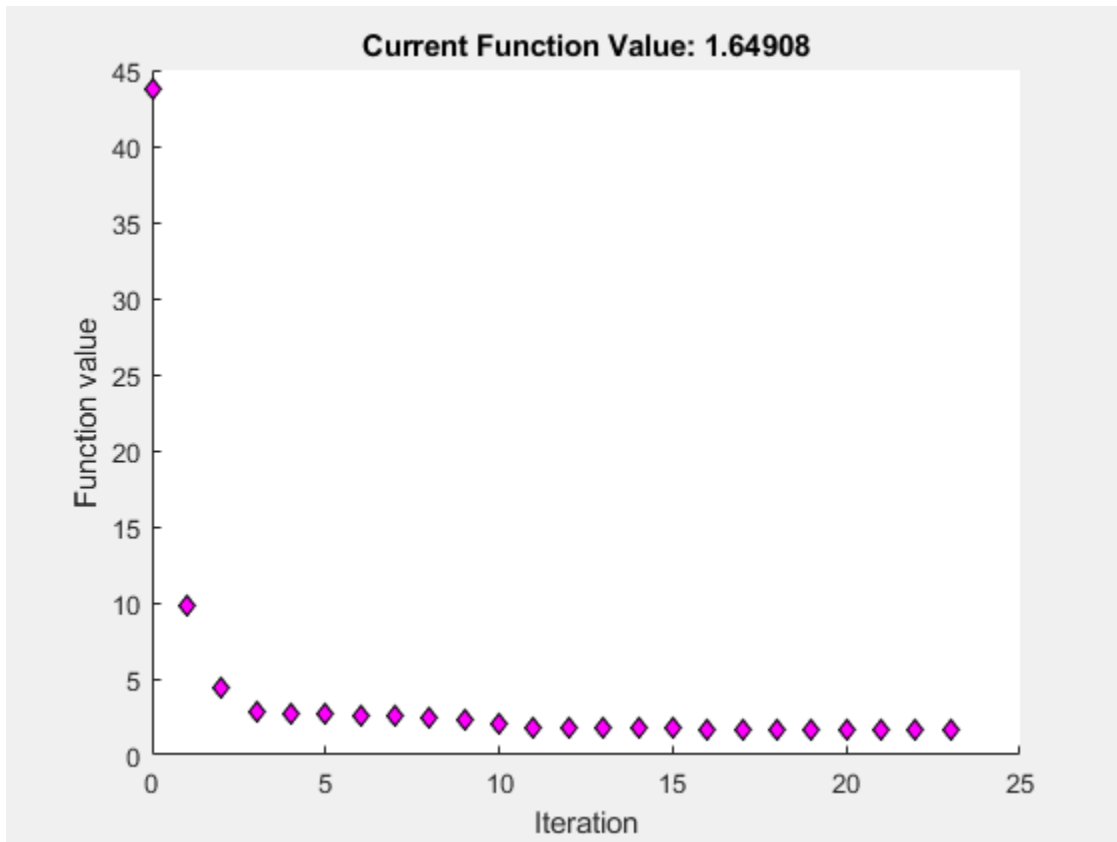

Compare the simulation before and after fitting.

```
gastroSims = selectbyname([gastroInitSim gastroFitSims], 'Glu Appear Rate');

figure;
plot(gastroSims(1).Time , gastroSims(1).Data , '- ' , ...
     gastroSims(2).Time , gastroSims(2).Data , '-- ' , ...
     gastroSims(3).Time , gastroSims(3).Data , '-.' , ...
     fitData.Time      , fitData.GluRate, 'x' );

xlabel('Time (hour)');
ylabel('mg/min');
legend('Reported', 'Estimated (nlinfit)', ...
      'Estimated (fminunc)', 'Experimental');
title('Glucose Appearance Fit');
```

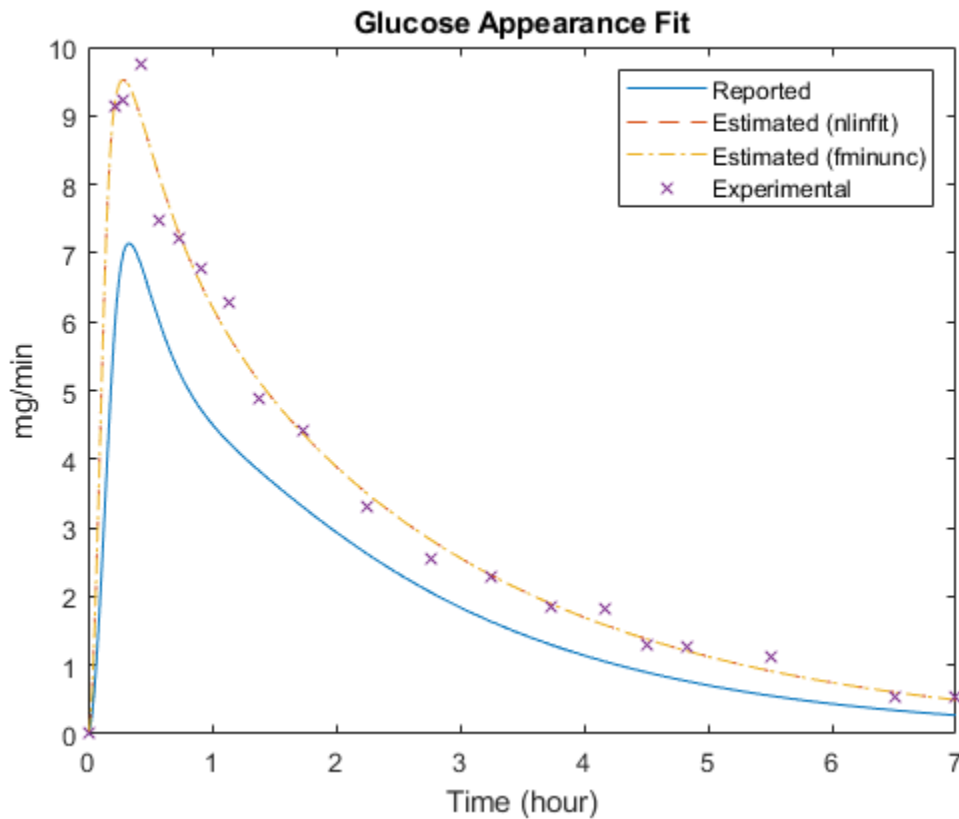

Plot the change in parameter values, relative to reported values.

```
figure;
fitResults = [gastroFitResults(1).ParameterEstimates.Estimate ...
             gastroFitResults(2).ParameterEstimates.Estimate];
% The initial values for kmax, kmin, and kabs come from the model.
gastroFitInitValues = [
    get(sbioselect(m1, 'Name', 'kmax'), 'Value')
    get(sbioselect(m1, 'Name', 'kmin'), 'Value')
    get(sbioselect(m1, 'Name', 'kabs'), 'Value')
    gastroFitEst(4).InitialValue
];
relFitChange = fitResults ./ [gastroFitInitValues gastroFitInitValues] - 1;
bar(relFitChange);
ax = gca;
ax.XTickLabel = {gastroFitEst.Name};
ylabel('Relative change in estimated values');
title('Comparing Reported and Estimated Gastrointestinal Parameter Values');
legend({'nlinfit', 'fminunc'}, 'Location', 'North')
```

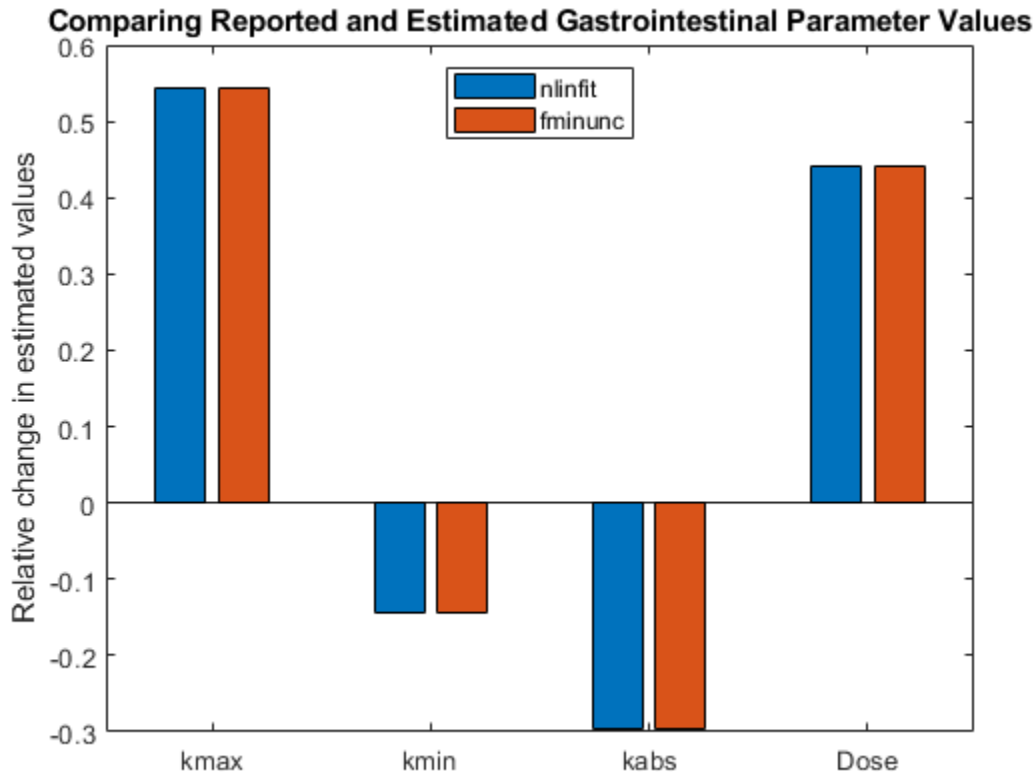

Note that the model fits the experimental data significantly better if the meal size (Dose) is significantly larger than reported, the parameter `kmax` is significantly larger than reported, and `kabs` is smaller than reported.

Fitting the Muscle and Adipose Tissue Model of Glucose Utilization

The muscle and adipose tissue model represents how glucose is utilized in the body. The "inputs" to this subsystem are the concentration of insulin in the plasma (`Plasma Ins Conc`), the endogenous glucose production (`Glu Prod`), and the rate of appearance of glucose (`Glu Appear Rate`). The "outputs" are the concentration of glucose in the plasma (`Plasma Glu Conc`) and the rate of glucose utilization (`Glu Util`).

Because the inputs are a function of time, they need to be implemented as forcing functions. Specifically, the values of `Plasma Ins Conc`, `Glu Prod`, and `Glu Appear Rate` are controlled by repeated assignments that call functions to do linear interpolation of the reported experimental values. When using these functions to control a species or parameter, you must make inactive any other rule that is used to set its value. To facilitate the selection of these rules, the rule Name properties contain meaningful names.

```
% Create forcing functions for the "inputs":
% Plasma Insulin
PlasmaInsRule = sbioselect(m1, 'Name', 'Plasma Ins Conc definition');
PlasmaInsForcingFcn = sbioselect(m1, 'Name', 'Plasma Ins Conc forcing function')

PlasmaInsForcingFcn =
    SimBiology Rule Array
```

```

Index:      RuleType:      Rule:
1          repeatedAssignment  [Plasma Ins Conc] = [picomole per liter]*PlasmaInsulin(time/[

PlasmaInsRule.Active      = false;
PlasmaInsForcingFcn.Active = true;

% Endogenous Glucose Production (Glu Prod)
GluProdRule      = sbioselect(m1, 'Name', 'Glu Prod definition');
GluProdForcingFcn = sbioselect(m1, 'Name', 'Glu Prod forcing function')

GluProdForcingFcn =
    SimBiology Rule Array

Index:      RuleType:      Rule:
1          repeatedAssignment  [Glu Prod] = [milligram per minute]*EndogenousGlucoseProducti

GluProdRule.Active      = false;
GluProdForcingFcn.Active = true;

% Glucose Rate of Appearance (Glu Appear Rate)
GluRateRule      = sbioselect(m1, 'Name', 'Glu Appear Rate definition');
GluRateForcingFcn = sbioselect(m1, 'Name', 'Glu Appear Rate forcing function')

GluRateForcingFcn =
    SimBiology Rule Array

Index:      RuleType:      Rule:
1          repeatedAssignment  [Glu Appear Rate] = [milligram per minute]*GlucoseAppearanceR

GluRateRule.Active      = false;
GluRateForcingFcn.Active = true;

% Simulate with the initial parameter values
muscleInitSim = sbiosimulate(m1);

% Identify which model components corresponds to observed data variables.
muscleFitObs = {'[Plasma Glu Conc] = PlasmaGluConc', ...
    '[Glu Util] = GluUtil'};

% Estimate the value of the following parameters:
muscleFitEst = estimatedInfo({'[Plasma Volume (Glu)]', 'k1', 'k2', ...
    'Vm0', 'Vmx', 'Km', 'p2U'});

% Ensure the parameter estimates are always positive during estimation by
% using a log transform on all parameters.
[muscleFitEst.Transform] = deal('log');

% Fit the data, displaying output at each iteration
[muscleFitResults, muscleFitSim] = sbiofit(m1, fitData, ...
    muscleFitObs, muscleFitEst, [], 'nlinfit', fitOptions);

Iteration      SSE      Norm of      Norm of
                SSE      Gradient      Step
-----

```

0	2181.51		
1	616.336	6826.17	0.494514
2	426.721	8055.96	0.454639
3	371.887	11968.3	0.882069
4	255.6	2221.87	0.163143
5	247.162	1167.02	0.0246181
6	247.05	2852.4	0.0214781
7	241.805	738.802	0.0111547
8	241.805	932.979	0.0011313
9	241.771	1412.43	0.000249884
10	241.767	1827.53	0.000101224
11	241.767	1700.25	3.11774e-17

Iterations terminated: relative norm of the current step is less than OPTIONS.TolX

Plot the change in parameter values, relative to reported values.

```
figure;
muscleFitInitValues = [
    get(sbioselect(m1, 'Name', 'Plasma Volume (Glu)'), 'Value')
    get(sbioselect(m1, 'Name', 'k1'), 'Value')
    get(sbioselect(m1, 'Name', 'k2'), 'Value')
    get(sbioselect(m1, 'Name', 'Vm0'), 'Value')
    get(sbioselect(m1, 'Name', 'Vmx'), 'Value')
    get(sbioselect(m1, 'Name', 'Km'), 'Value')
    get(sbioselect(m1, 'Name', 'p2U'), 'Value')
];

bar(muscleFitResults.ParameterEstimates.Estimate ./ muscleFitInitValues - 1);
ax = gca;
ax.XTickLabel = {muscleFitEst.Name};
ylabel('Relative change in estimated values');
title('Comparing Reported and Estimated Glucose Parameter Values');
```

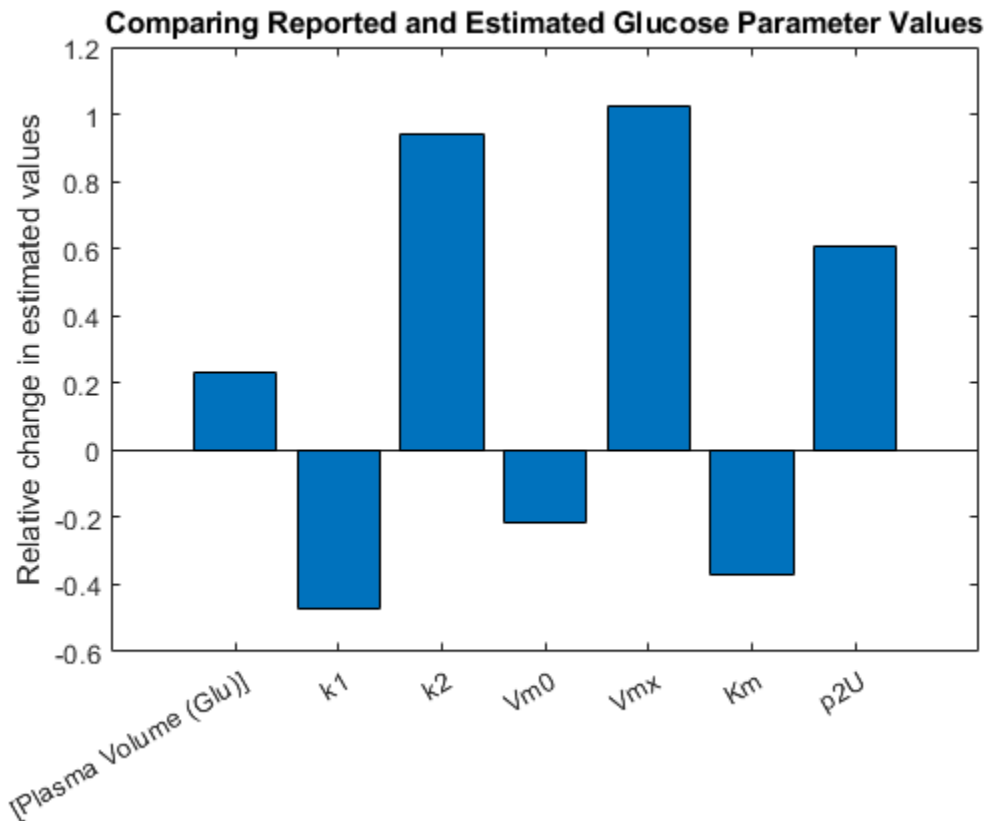

Clean up the changes to the model.

```
PlasmaInsRule.Active = true;
GluProdRule.Active   = true;
GluRateRule.Active   = true;
```

```
PlasmaInsForcingFcn.Active = false;
GluProdForcingFcn.Active   = false;
GluRateForcingFcn.Active   = false;
```

Compare the simulation before and after fitting

```
muscleSims = selectbyname([muscleInitSim muscleFitSim], ...
    {'Plasma Glu Conc', 'Glu Util'});
figure;
plot(muscleSims(1).Time, muscleSims(1).Data(:,1), '-', ...
    muscleSims(2).Time, muscleSims(2).Data(:,1), '--', ...
    fitData.Time, fitData.PlasmaGluConc, 'x');
xlabel('Time (hour)');
ylabel('mg/dl');
legend('Initial (Simulation)', 'Estimated (Simulation)', 'Experimental');
title('Plasma Glucose Fit');
```

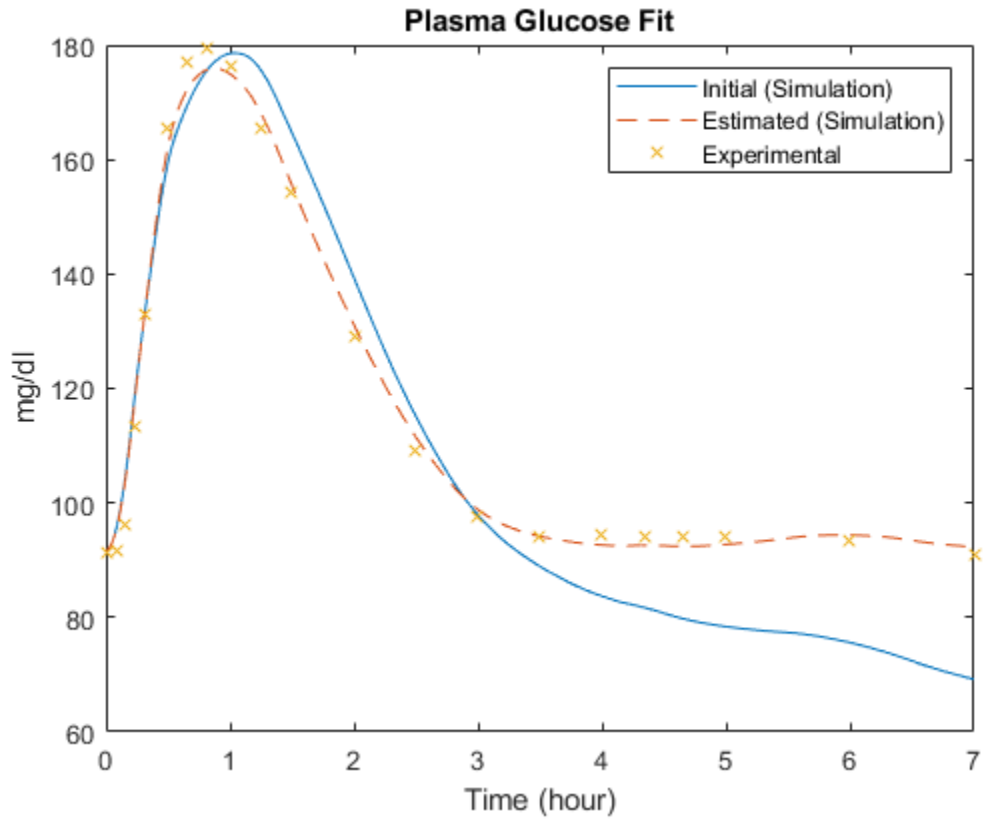
```
figure;
plot(muscleSims(1).Time, muscleSims(1).Data(:,2), '-', ...
     muscleSims(2).Time, muscleSims(2).Data(:,2), '--', ...
     fitData.Time, fitData.GluUtil, 'x');
xlabel('Time (hour)');
ylabel('mg/min');
legend('Initial (Simulation)', 'Estimated (Simulation)', 'Experimental');
title('Glucose Utilization Fit');
```

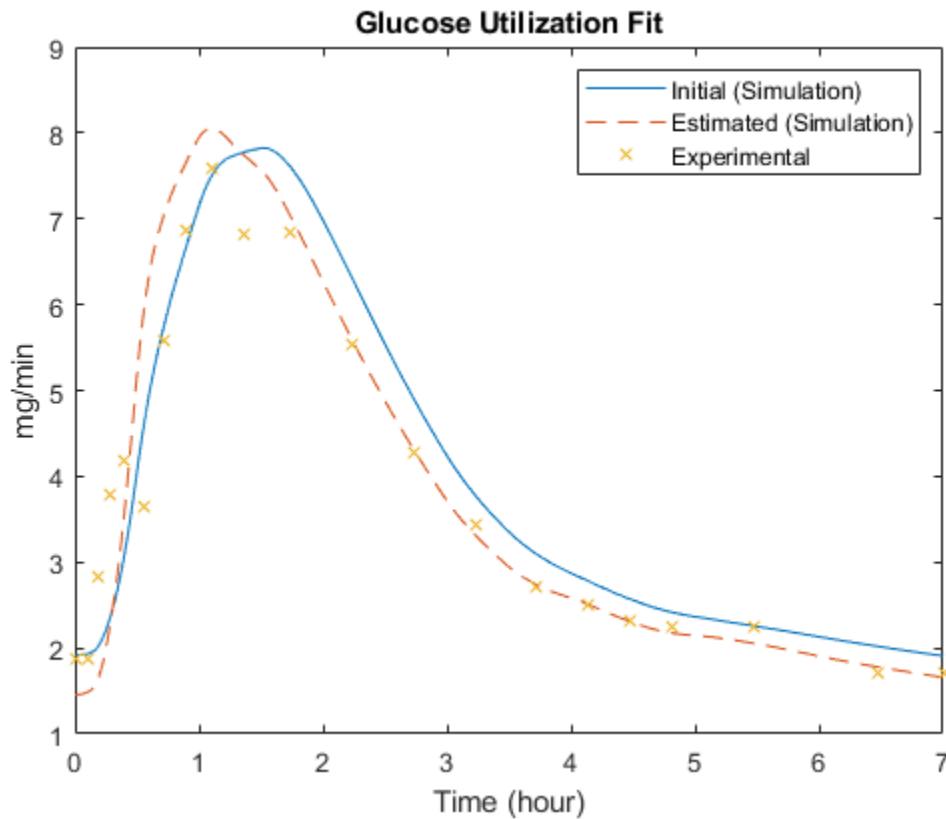

Note that significantly increasing some parameters, such as V_{mx} , allows a much better fit of late-time plasma glucose concentrations.

Cleanup

Restore warning settings.

```
warning(warnSettings);
```

Conclusions

SimBiology contains several features that facilitate the implementation and simulation of a complex model of the glucose-insulin system. Reactions, events, and rules provide a natural way to describe the dynamics of the system. Unit conversion allows species and parameters to be specified in convenient units and ensures the dimensional consistency of the model. Dose objects are a simple way to describe recurring inputs to a model, such as the daily meal schedule in this example. SimBiology also provides built-in support for analysis tasks like simulation and parameter estimation.

PK/PD Modeling and Simulation to Guide Dosing Strategy for Antibiotics

This example shows how to perform a Monte Carlo simulation of a pharmacokinetic/pharmacodynamic (PK/PD) model for an antibacterial agent. This example is adapted from Katsube et al. [1] This example also shows how to use the SimBiology® SimFunction object to perform parameter scans in parallel.

This example requires Statistics and Machine Learning Toolbox™. The performance can be improved if you have the Parallel Computing Toolbox™ software.

Background

Katsube et al. [1] used a PK/PD modeling and simulation approach to determine the most effective dosage regimens for doripenem, a carbapenem antibiotic. The objectives of their study were:

- Develop a PK/PD model to describe the antibacterial effect of doripenem against several *Pseudomonas aeruginosa* strains
- Use Monte Carlo simulations to compare the efficacy of four common antibiotic dosage regimes, and to determine the most effective dosing strategy
- Investigate the effect of renal function on the antibacterial efficacy of the treatments

In this example, we will implement the antibacterial PK/PD model developed by Katsube et al. [1] in SimBiology®, and replicate the results of the Monte Carlo simulation described in their work.

References

[1] T. Katsube, Y. Yano, T. Wajima, Y. Yamano and M. Takano. Pharmacokinetic/pharmacodynamic modeling and simulation to determine effective dosage regimens for doripenem. *Journal of Pharmaceutical Sciences* (2010) 99(5), 2483-91.

PK/PD Model

Katsube et al. assumed a two-compartment infusion model with linear elimination from the central compartment to describe the pharmacokinetics of the doripenem. For the bacterial growth model, they assumed that the total bacterial population is comprised of drug-susceptible growing cells and drug-insensitive resting cells. The antibacterial effect of the drug was included in the killing rate of the bacteria via a simple Emax type model:

$$KillingRate = \frac{K_{max} * [Drug] * [Growing]}{KC50 + [Drug]}$$

where [Drug] is the concentration (ug/ml) of the drug in the central compartment, and [Growing] is the count of the growing bacterial population in CFU/ml (CFU = Colony Forming Units). Kmax is the maximal killing rate constant (1/hour) and KC50 is the Michaelis-Menten rate constant (ug/ml).

A graphical view of the SimBiology implementation of the model is shown below.

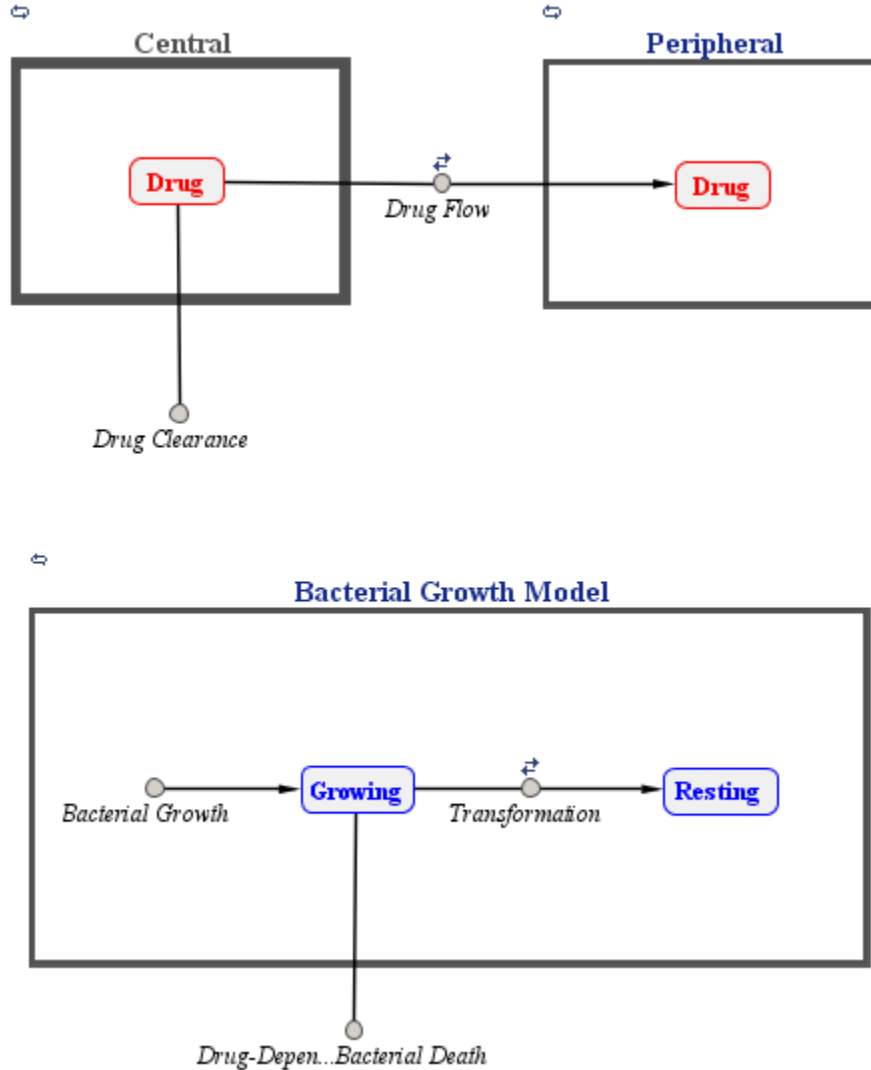

```
% Load model
sbioloadproject('AntibacterialPKPD.sbproj', 'm1');
```

Dosage Regimens

Katsube et al. simulated the model using four common antibiotic dosage strategies.

- 250 mg two times a day (b.i.d.)
- 250 mg three times a day (t.i.d.)
- 500 mg two times a day (b.i.d.)
- 500 mg three times a day (t.i.d.)

Infusion dosing was used in all four dosages regimens, and infusion time was set to 30 minutes. In SimBiology, these dosage regimens have been implemented as dose objects.

```
% Select dose objects in the model
doseNames = {'250 mg bid', '250 mg tid', '500 mg bid', '500 mg tid'};
```

```

for iDoseGrp = 1:length(doseNames)
    doseRegimens(iDoseGrp) = sbioselect(m1, 'Name', doseNames{iDoseGrp}) ;
end

```

Description of the Virtual Population

A virtual population of individuals was generated based on the distribution of demographic variables and PK/PD parameters. The type of distribution and the values of the distribution parameters were based on data from earlier clinical trials of doripenem conducted in Japan.

Note: In [1], 5,000 virtual patients were simulated in each dosage group. In this example, we will use 1,000 patients in each group. To simulate a different population size, change the value of nPatients below.

```

% Setup
nPatients      = 1000          ; % Number of patients per dosage group
nDoseGrps      = 4            ; % Number of tested dosage regimens

```

Distribution of Demographic Variables:

Weight (Wt) and age (Age) were sampled from a normal distribution with a mean of 51.6 kg and 71.8 years, respectively, and a standard deviation of 11.8 kg and 11.9 years, respectively. 26% of the population was assumed to be female. Serum creatinine levels (Scr) were sampled from a lognormal distribution with the typical value (geometric mean) of 0.78 mg/dL, and coefficient of variation (CV) of 32.8%. The creatinine clearance rates (CrCL) were calculated using the Cockcroft-Gault equation.

The inputs to the lognrnd function are the mean (mu) and standard deviation (sigma) of the associated normal distribution. Here and throughout the example, mu and sigma were calculated from the reported typical value and coefficient of variation of the lognormal distribution. You can use the following definitions to calculate them. See the lognstat documentation for more information.

```

mu      = @(m,v) log(m^2/sqrt(v+m^2));
sigma   = @(m,v) sqrt(log(v/m^2+1));
m       = @(typicalValue) typicalValue;
v       = @(typicalValue,CV) typicalValue^2*CV^2;

```

```

% Patient demographics
rng('default');
Wt      = normrnd(51.6, 11.8, nPatients , nDoseGrps ) ; % units: kg
Age     = normrnd(71.8, 11.9, nPatients , nDoseGrps ) ; % units: years
Scr_mu  = mu(m(0.78), v(0.78,0.328));
Scr_sigma = sigma(m(0.78), v(0.78,0.328));
Scr     = lognrnd(Scr_mu, Scr_sigma, nPatients , nDoseGrps ) ; % units: ml/minute
% Gender ratio
id      = 1:nPatients*nDoseGrps ;
idFemale = randsample(id , round(0.26*nDoseGrps*nPatients)) ; % 26% Female

```

Creatinine Clearance (using Cockcroft-Gault equation)

```

CrCL      = (140 - Age).*Wt./(Scr*72) ; % units: ml/minute
CrCL(idFemale) = CrCL(idFemale)*0.85 ; % multiply by 0.85 for females

```

Distribution of Pharmacokinetic (PK) parameters:

PK parameters, Central, k12, and k21, were sampled from a lognormal distribution with typical values of 7.64 liters, 1.59 1/hour and 2.26 1/hour, respectively, and a 20% coefficient of variation

(CV). `Central` is the distribution volume of the central compartment, and `k12` and `k21` are transfer rate constants between the `Central` and the `Peripheral` compartments.

```
Central_mu    = mu(m(7.64), v(7.64,0.20));
Central_sigma = sigma(m(7.64), v(7.64,0.20));
k12_mu       = mu(m(1.59), v(1.59,0.20));
k12_sigma    = sigma(m(1.59), v(1.59,0.20));
k21_mu       = mu(m(2.26), v(2.26, 0.2));
k21_sigma    = sigma(m(2.26), v(2.26, 0.2));

Central = lognrnd(Central_mu , Central_sigma, nPatients , nDoseGrps); % units: liter
k12     = lognrnd(k12_mu, k12_sigma, nPatients , nDoseGrps)           ; % units: 1/hour
k21     = lognrnd(k21_mu, k21_sigma, nPatients , nDoseGrps)           ; % units: 1/hour
```

The drug clearance rate, `CL`, was assumed to depend linearly on the creatinine clearance rate via the following equation:

$$CL = 1.07 * CrCL + 45.6 + \varepsilon$$

where ε is the additive residual error sampled from a normal distribution with a mean of 0 ml/minute and standard deviation of 22 ml/minute.

```
CL = 1.07*CrCL + 45.6 + normrnd(0,22,nPatients,nDoseGrps); % units: ml/minute
```

Distribution of Pharmacodynamic (PD) parameters:

Growing-to-resting transformation rate constants, `k1` and `k2`, were sampled from a lognormal distribution with typical value of 5.59e-5 and 0.0297 1/hour, respectively, each with a CV of 20%. `Kmax` was sampled from a lognormal distribution with a typical value of 3.5 1/hour and 15.9% CV.

```
k1_mu    = mu(m(5.59e-5), v(5.59e-5, 0.2));
k1_sigma = sigma(m(5.59e-5), v(5.59e-5, 0.2));
k2_mu    = mu(m(0.0297) , v(0.0297, 0.2));
k2_sigma = sigma(m(0.0297) , v(0.0297, 0.2));
Kmax_mu  = mu(m(3.50)   , v(3.50, 0.159));
Kmax_sigma = sigma(m(3.50)   , v(3.50, 0.159));

k1 = lognrnd(k1_mu, k1_sigma, nPatients , nDoseGrps) ; % units: 1/hour
k2 = lognrnd(k2_mu, k2_sigma, nPatients , nDoseGrps) ; % units: 1/hour
Kmax = lognrnd(Kmax_mu, Kmax_sigma, nPatients , nDoseGrps) ; % units: 1/hour
```

Katsube et al. assumed that values `k1`, `k2` and `Kmax` were independent of the bacterial strain being treated. The value of `Beta`, the net growth rate constant, was fixed at 1.5 1/hour.

Based on experiments with several strains, the authors concluded that the value of `KC50` was linearly dependent on the minimum inhibition concentration (MIC) of bacterial strain via the following equation.

$$\ln(KC50) = -1.91 + 0.898 * \ln(MIC) + \varepsilon$$

where ε is the additive residual error sampled from a normal distribution with a mean of 0 and standard deviation of 1.06 ug/ml. In the simulation, the MIC values were sampled from a discrete distribution, and the `KC50` value was calculated for the selected MIC using the above equation.

```
% Discrete distribution of MIC values based on 71 P. aeruginosa strains
micValue = [0.0625, 0.125, 0.25, 0.5 , 1 , 2 , 4 , 8 , 16 , 32 ] ;
micFreq  = [ 5 , 8 , 9 , 14 , 7 , 8 , 9 , 5 , 2 , 4 ] ;
```

```

% Sample MIC values from a discrete distribution using randsample
MIC = nan(nPatients, nDoseGrps) ; % preallocate
for iDoseGrp = 1:nDoseGrps
    MIC(:, iDoseGrp) = randsample(micValue , nPatients, true , micFreq);
end

KC50 = exp(-1.91 + 0.898*log(MIC) + 1.06*randn(nPatients , nDoseGrps)) ; % units: microgram/milliliter

```

Simulation Setup & Design

Create a `SimFunction` object that lets you perform model simulations and parameter scans in parallel. In this example, you will vary 8 parameters, `Central`, `k12`, `k21`, `CL`, `k1`, `k2`, `Kmax`, and `KC50`. Select the growing and resting bacterial counts, `Growing` and `Resting`, as responses, that is, simulation results that you want to observe while varying those input parameters.

Select the parameters to vary.

```
params = {'Central', 'k12', 'k21', 'CL', 'k1', 'k2', 'Kmax', 'KC50'};
```

Select the responses.

```
observables = {'[Bacterial Growth Model].Growing',...
               '[Bacterial Growth Model].Resting'};
```

Set up a template dose.

```
tempdose = sbiodose('dose');
tempdose.Target = 'Central.Drug';
tempdose.AmountUnits = 'milligram';
tempdose.TimeUnits = 'hour';
tempdose.DurationParameterName = 'TDose';
```

Create a `SimFunction` object. Set `UseParallel` to true to enable parallel computing.

```
simfunc = createSimFunction(m1,params,observables,tempdose,'UseParallel',true);
```

Create an input matrix `phi` for each dosage group.

```
phi = cell(1,nDoseGrps);
for i = 1:nDoseGrps
    phi{i} = [Central(:,i),k12(:,i),k21(:,i), ...
              CL(:,i), k1(:,i), k2(:,i), ...
              Kmax(:,i), KC50(:,i)];
end
```

Cluster Computing

This example uses the local cluster profile that is pre-configured to your local machine. You can also search for other MATLAB® Parallel Server™ clusters that are running on Amazon EC2®. On the **Home** tab in the **Environment** section, select **Parallel > Discover Clusters**. To access these clusters, you must provide your MathWorks® Account login information. For details, see “Discover Clusters and Use Cluster Profiles” (Parallel Computing Toolbox).

Create a parallel pool if none exists.

```
if isempty(gcp)
    parpool;
end
```

```
Starting parallel pool (parpool) using the 'local' profile ...
Connected to the parallel pool (number of workers: 6).
```

For all dosage scenarios, the model was simulated until $t = 2$ weeks from the time of the first dose. Total bacterial count, CFU, was sampled every 24 hours (once a day) for the entire duration of the dosage regimen.

```
tObs      = 0:24:336      ; % hour
nTPoints  = length(tObs)  ; % Number of sampling points
```

Monte Carlo Simulation of Patients with Severe Infection

The antibacterial efficacy of a drug can be measured using different PK/PD indices. Katsube et al. set the criterion for bacterial elimination at $\log_{10}(\text{CFU}) < 0$, where CFU is the total bacterial count. The efficacy of each dose regimen was measured as the fraction of the population that achieved the success criteria in the dosage group. This efficacy metric, $\Pr\{\log_{10}(\text{CFU}) < 0\}$, was tracked as a function of time for each dosage group.

In their simulation studies, the authors investigated the efficacy of the dosage regimens on two classes of patients:

- Moderate infection (Initial bacterial count = $1e4$ CFU/ml)
- Severe infection (Initial bacterial count = $1e7$ CFU/ml)

In this example, we will replicate the results for the severe infection case only. Note that you can easily simulate the other scenario, patients with moderate infection, by changing the initial amount of bacterial count (the Growing species), in the model to $1e4$ CFU/ml.

```
% Preallocate
cfu      = nan(nTPoints,nPatients);
log10CFU = cell(1,nDoseGrps) ;

for i = 1:nDoseGrps
    disp(['Simulating group ', num2str(i), '...'])

    % Get the dose table directly from an existing dose object for each
    % dosing regimen.
    doseTable = getTable(doseRegimens(i));

    % Simulate
    simdata = simfunc(phi{i},[],doseTable,tObs);

    % Sum of growing and resting bacterial counts for each patient
    for j = 1:nPatients
        cfu(:,j) = sum(simdata(j).Data,2);
    end
    % Store log-transformed counts for each dose group.
    log10CFU{i} = log10(cfu);
end

% Save results
log10CFU_250bid = log10CFU{1} ;
log10CFU_250tid = log10CFU{2} ;
log10CFU_500bid = log10CFU{3} ;
log10CFU_500tid = log10CFU{4} ;

Simulating group 1...
Simulating group 2...
```



```

Simulating group 3...
Simulating group 4...

```

Shut down the parallel pool.

```
delete(gcf('nocreate'));
```

Time Course Profiles of Bacterial Counts

We plot the median (in red) and percentile (shaded) profiles of the \log_{10} (CFU) levels for all four dosage regimens. Observe that in all four groups, the median time course profile shows that bacterial eradication is complete before the end of the treatment period (336 hours). However, it is evident from the higher percentile profiles that the treatments are not successful for all patients. The 95th and 90th percentile profiles also indicate that dosing a lower amount with a higher frequency (250 tid) is more effective than less frequent dosing with higher amount (500 bid).

```

hax1(1) = subplot(2,2,1)
plotCFUCount(tObs, log10CFU_250bid, 'a. Dose 250 bid' )
hax1(2) = subplot(2,2,2)
plotCFUCount(tObs, log10CFU_250tid, 'b. Dose 250 tid' )
hax1(3) = subplot(2,2,3)
plotCFUCount(tObs, log10CFU_500bid, 'c. Dose 500 bid' )
hax1(4) = subplot(2,2,4)
plotCFUCount(tObs, log10CFU_500tid, 'd. Dose 500 tid' )

```

```

% Link subplot axes
linkaxes(hax1)

```

```
hax1 =
```

```
  Axes with properties:
```

```

        XLim: [0 1]
        YLim: [0 1]
        XScale: 'linear'
        YScale: 'linear'
  GridLineStyle: '-'
  Position: [0.1300 0.5838 0.3347 0.3412]
        Units: 'normalized'

```

```
Use GET to show all properties
```

```
hax1 =
```

```
  1×2 Axes array:
```

```
  Axes    Axes
```

```
hax1 =
```

```
  1×3 Axes array:
```

```
  Axes    Axes    Axes
```

hax1 =

1×4 Axes array:

Axes Axes Axes Axes

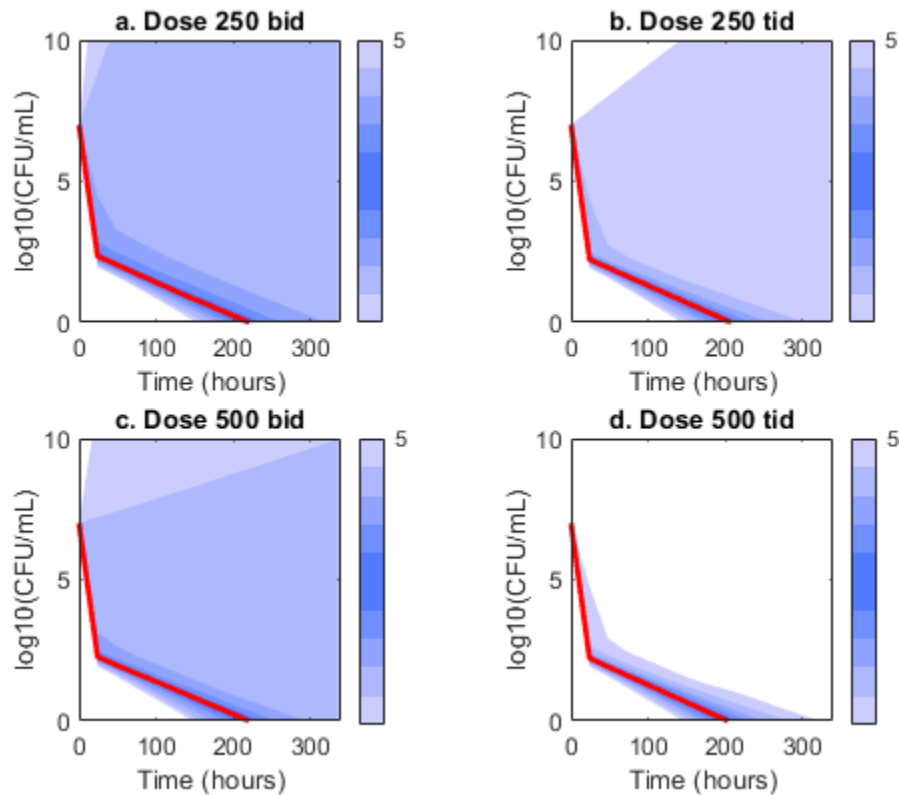

Effect of Renal Function on Antibacterial Activity

Finally, the authors compared the efficacy profiles of the dosages regimens as a function of the renal function. They classified the patients into four renal function groups based on the creatinine clearance rates (CrCL):

- Creatinine Clearance Group 1: $\text{CrCL} < 30$
- Creatinine Clearance Group 2: $30 \leq \text{CrCL} < 50$
- Creatinine Clearance Group 3: $50 \leq \text{CrCL} < 70$
- Creatinine Clearance Group 4: $\text{CrCL} \geq 70$

The next figure shows the effect of renal function (creatinine clearance rate) on the antibacterial efficacy of the four dosage regimens. Observe that in the normal renal function group ($\text{CrCL} \geq 70$), the efficacy profiles of the four treatment strategies are significantly different from each other. In this case, the 500 mg t.i.d. dose is much more effective than the other regimens. In contrast, simulations involving patients with renal dysfunction ($\text{CrCL} < 30$ and $30 \leq \text{CrCL} < 50$), we don't see much difference between the treatment groups. This indicates that for patients with a renal dysfunction, a less intense or less frequent dosing strategy would work almost as well as a dosing strategy with higher frequency or dosing amount.

```

% Preallocate
idCrCLGrp = false(nPatients, nDoseGrps) ;

% Line Style
ls = {'bd:', 'b*:', 'rd:', 'r*:'} ;

titleStr = {'CL_c_r < 30'           , ...
            '30 <= CL_c_r < 50'    , ...
            '50 <= CL_c_r < 70'    , ...
            'CL_c_r > 70'          };

f = figure;
f.Color = 'w'

for iCrCLGrp = 1:4 % Creatinine Clearance Groups

    hax2(iCrCLGrp) = subplot(2,2, iCrCLGrp) ;
    title( titleStr{iCrCLGrp} ) ;
    ylabel('Prob(log10CFU < 0)' ) ;
    xlabel('Time (hours)' ) ;

end

% Set axes properties
set(hax2, 'XTick'           , 0:48:336           , ...
         'XTickLabel'      , 0:48:336           , ...
         'Ylim'            , [0 1]           , ...
         'Xlim'            , [0 336]          , ...
         'NextPlot'        , 'add'           , ...
         'Box'             , 'on'           );

% Plot results by renal function group:
for iDoseGrp = 1:nDoseGrps

    % Extract indices for renal function
    idCrCLGrp(:, 1) = CrCL(:,iDoseGrp) < 30 ;
    idCrCLGrp(:, 2) = CrCL(:,iDoseGrp) >= 30 & CrCL(:,iDoseGrp) < 50 ;
    idCrCLGrp(:, 3) = CrCL(:,iDoseGrp) >= 50 & CrCL(:,iDoseGrp) < 70 ;
    idCrCLGrp(:, 4) = CrCL(:,iDoseGrp) >= 70 ;

    for iCrCLGrp = 1:4 % Creatinine Clearance Groups

        % Calculate probability
        Pr = sum( ( log10CFU{iDoseGrp}(:, idCrCLGrp(:, iCrCLGrp)) < 0 ) , 2 )/sum(idCrCLGrp(:,iCrCLGrp))

        % Plot
        plot(hax2(iCrCLGrp), tObs, Pr , ls{iDoseGrp}, 'MarkerSize', 7)
    end

end

legend(hax2(4), {'250 b.i.d.', '250 t.i.d.', '500 b.i.d.', '500 t.i.d.'} )
legend location NorthWest
legend boxoff

linkaxes(hax2)

```

f =

Figure (1) with properties:

```

Number: 1
Name: ''
Color: [1 1 1]
Position: [680 678 560 420]
Units: 'pixels'
    
```

Use GET to show all properties

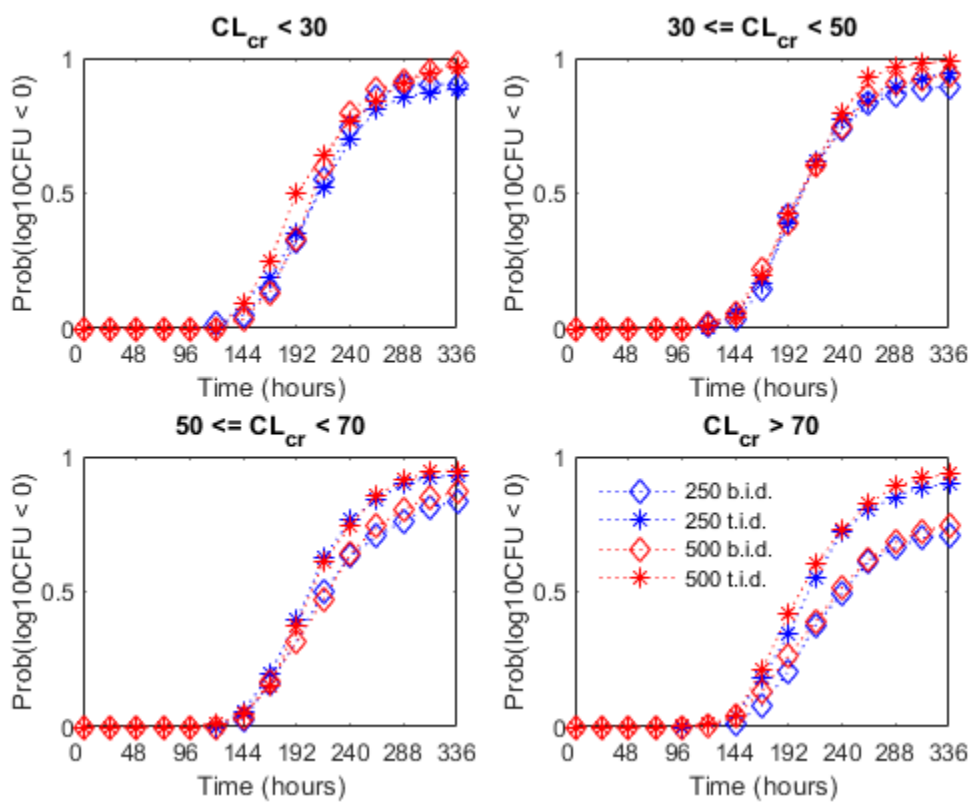

Fit PK Parameters Using SimBiology Problem-Based Workflow

This example shows how to estimate PK parameters of a SimBiology model using a problem-based approach.

Load a synthetic data set. It contains drug plasma concentration data measured in both central and peripheral compartments.

```
load('data10_32R.mat')
```

Convert the data set to a groupedData object.

```
gData = groupedData(data);
gData.Properties.VariableUnits = ["", "hour", "milligram/liter", "milligram/liter"];
```

Display the data.

```
sbiotrellis(gData, "ID", "Time", ["CentralConc", "PeripheralConc"], ...
    Marker="+", LineStyle="none");
```

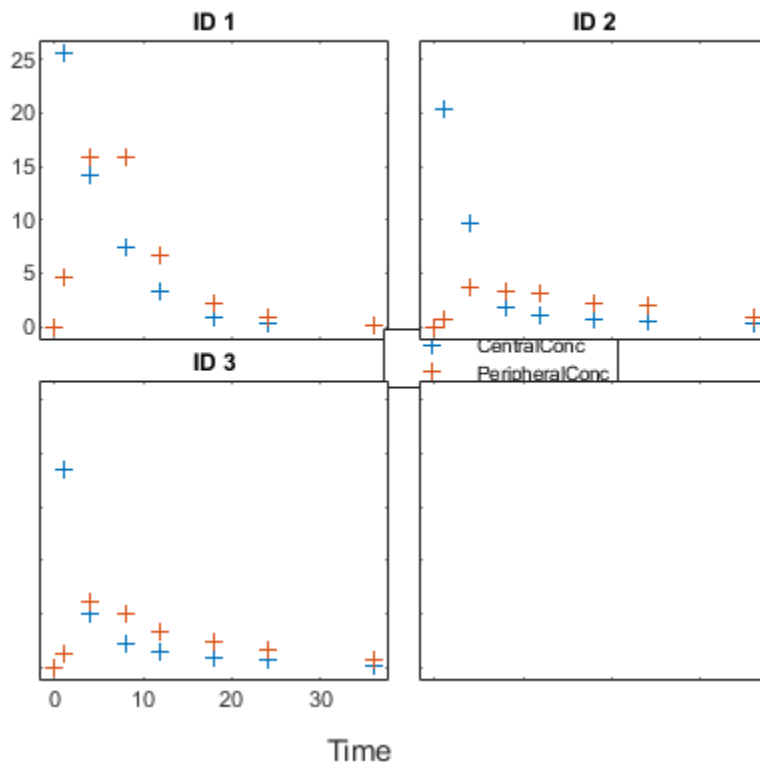

Use the built-in PK library to construct a two-compartment model with infusion dosing and first-order elimination. Use the configset object to turn on unit conversion.

```
pkmd = PKModelDesign;
pkc1 = addCompartment(pkmd, "Central");
pkc1.DosingType = "Infusion";
pkc1.EliminationType = "linear-clearance";
```

```

pkc1.HasResponseVariable = true;
pkc2                      = addCompartment(pkmd, "Peripheral");
model2cpt                 = construct(pkmd);
configset                 = getConfigset(model2cpt);
configset.CompileOptions.UnitConversion = true;

```

Assume every individual receives an infusion dose at time = 0, with a total infusion amount of 100 mg at a rate of 50 mg/hour. For details on setting up different dosing strategies, see “Doses in SimBiology Models” on page 2-30.

```

dose                      = sbiodose("dose", "TargetName", "Drug_Central");
dose.StartTime            = 0;
dose.Amount               = 100;
dose.Rate                 = 50;
dose.AmountUnits          = "milligram";
dose.TimeUnits            = "hour";
dose.RateUnits            = "milligram/hour";

```

Create a problem object.

```
problem = fitproblem
```

```
problem =
```

```
fitproblem with properties:
```

```
Required:
```

```

    Data: [0x0 groupedData]
    Estimated: [1x0 estimatedInfo]
    FitFunction: "sbiofit"
    Model: [0x0 SimBiology.Model]
    ResponseMap: [1x0 string]

```

```
Optional:
```

```

    Doses: [0x0 SimBiology.Dose]
    FunctionName: "auto"
    Options: []
    ProgressPlot: 0
    UseParallel: 0
    Variants: [0x0 SimBiology.Variant]

```

```
sbiofit options:
```

```

    ErrorModel: "constant"
    Pooled: "auto"
    SensitivityAnalysis: "auto"
    Weights: []

```

Define the required properties of the object.

```

problem.Data              = gData;
problem.Estimated         = estimatedInfo(["log(Central)", "log(Peripheral)", "Q12", "Cl_Central"], InitialConc);
problem.Model             = model2cpt;
problem.ResponseMap      = ["Drug_Central = CentralConc", "Drug_Peripheral = PeripheralConc"];

```

Define the dose to be applied during fitting.

```
problem.Doses            = dose;
```

Show the progress of the estimation.

```
problem.ProgressPlot = true;
```

Fit the model to all of the data pooled together: that is, estimate one set of parameters for all individuals by setting the Pooled property to true.

```
problem.Pooled = true;
```

Perform the estimation using the fit function of the object.

```
pooledFit = fit(problem);
```

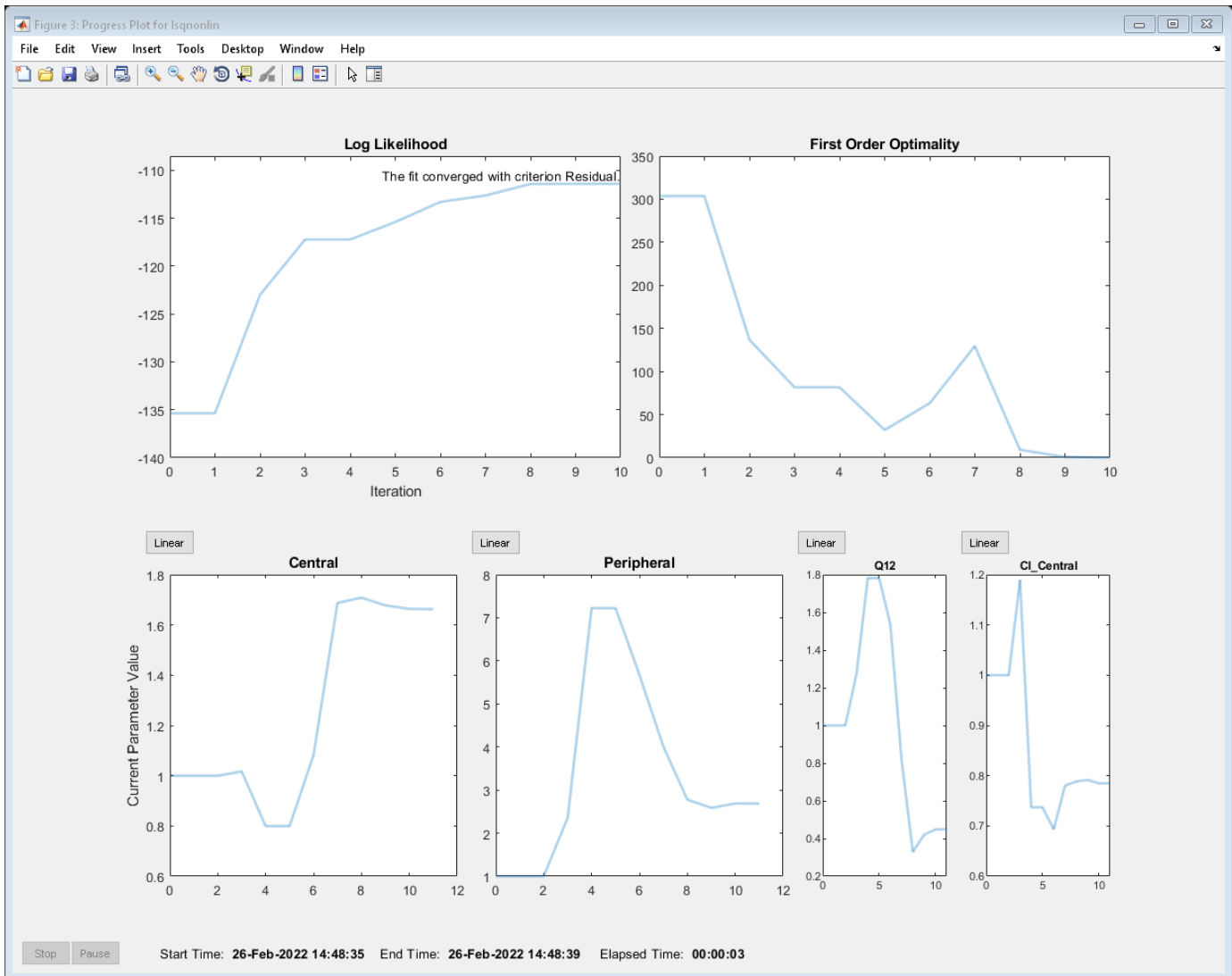

Display the estimated parameter values.

```
pooledFit.ParameterEstimates
```

```
ans=4x3 table
```

Name	Estimate	StandardError
_____	_____	_____
_____	_____	_____
_____	_____	_____
_____	_____	_____

4 Simulation and Analysis

```
{'Central' } 1.6627 0.16569  
{'Peripheral'} 2.6864 1.0644  
{'Q12' } 0.44945 0.19943  
{'Cl_Central'} 0.78497 0.095621
```

Plot the fitted results.

```
plot(pooledFit);
```

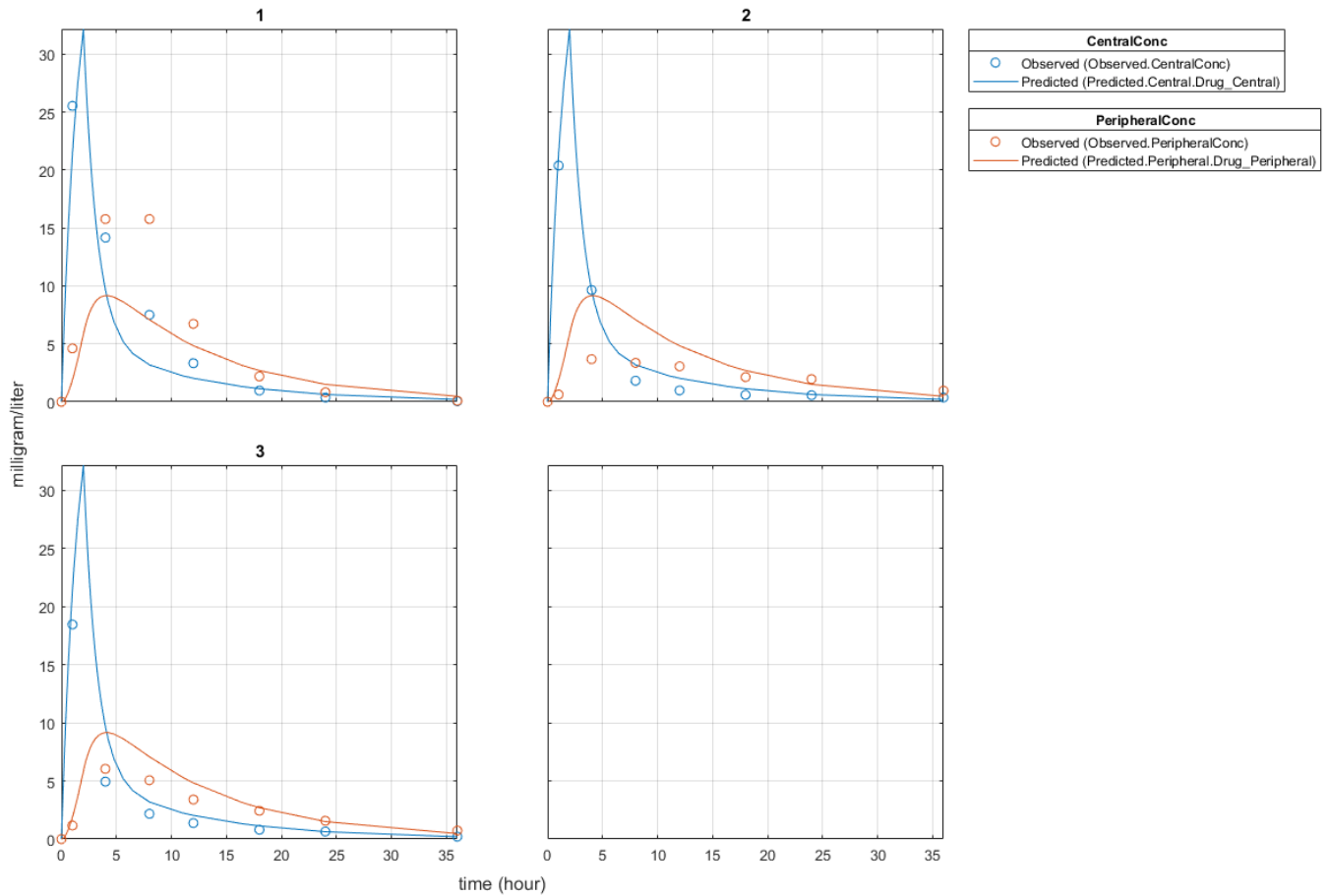

Estimate one set of parameters for each individual and see if the parameter estimates improve.

```
problem.Pooled = false;  
unpooledFit = fit(problem);
```

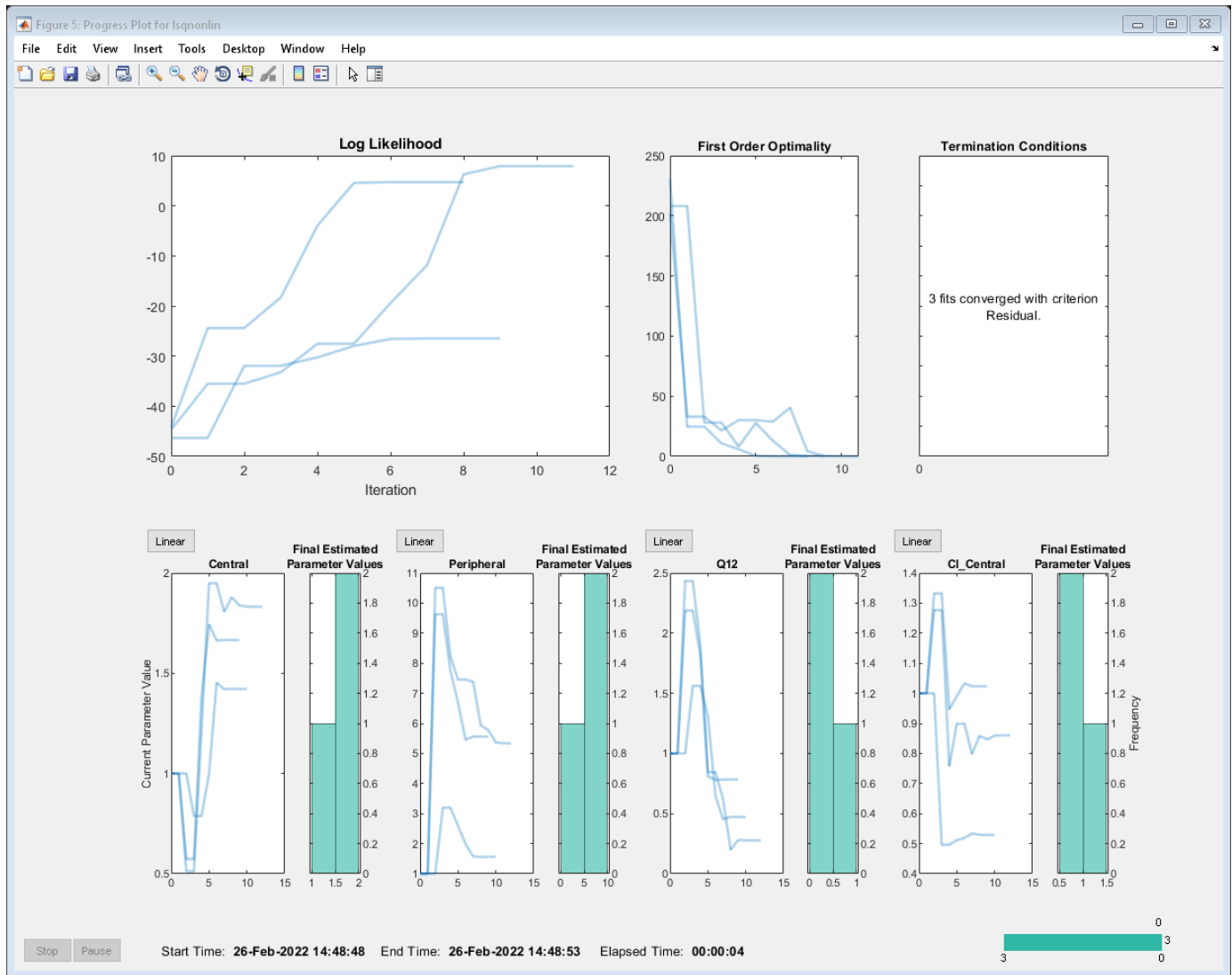
Display the estimated parameter values.

```
unpooledFit.ParameterEstimates
```

```
ans=4x3 table
```

Name	Estimate	StandardError
{'Central' }	1.422	0.12334
{'Peripheral' }	1.5619	0.36355
{'Q12' }	0.47163	0.15196
{'CL_Central' }	0.5291	0.036978

```
ans=4x3 table
```

Name	Estimate	StandardError
{'Central' }	1.8322	0.019672

```

{'Peripheral'}    5.3364    0.65327
{'Q12'}          0.2764    0.030799
{'Cl_Central'}   0.86035   0.026257
    
```

```

ans=4x3 table
      Name      Estimate      StandardError
-----
{'Central' }    1.6657    0.038529
{'Peripheral'}  5.5632    0.37063
{'Q12' }        0.78361   0.058657
{'Cl_Central'}  1.0233    0.027311
    
```

```
plot(unpooledFit);
```

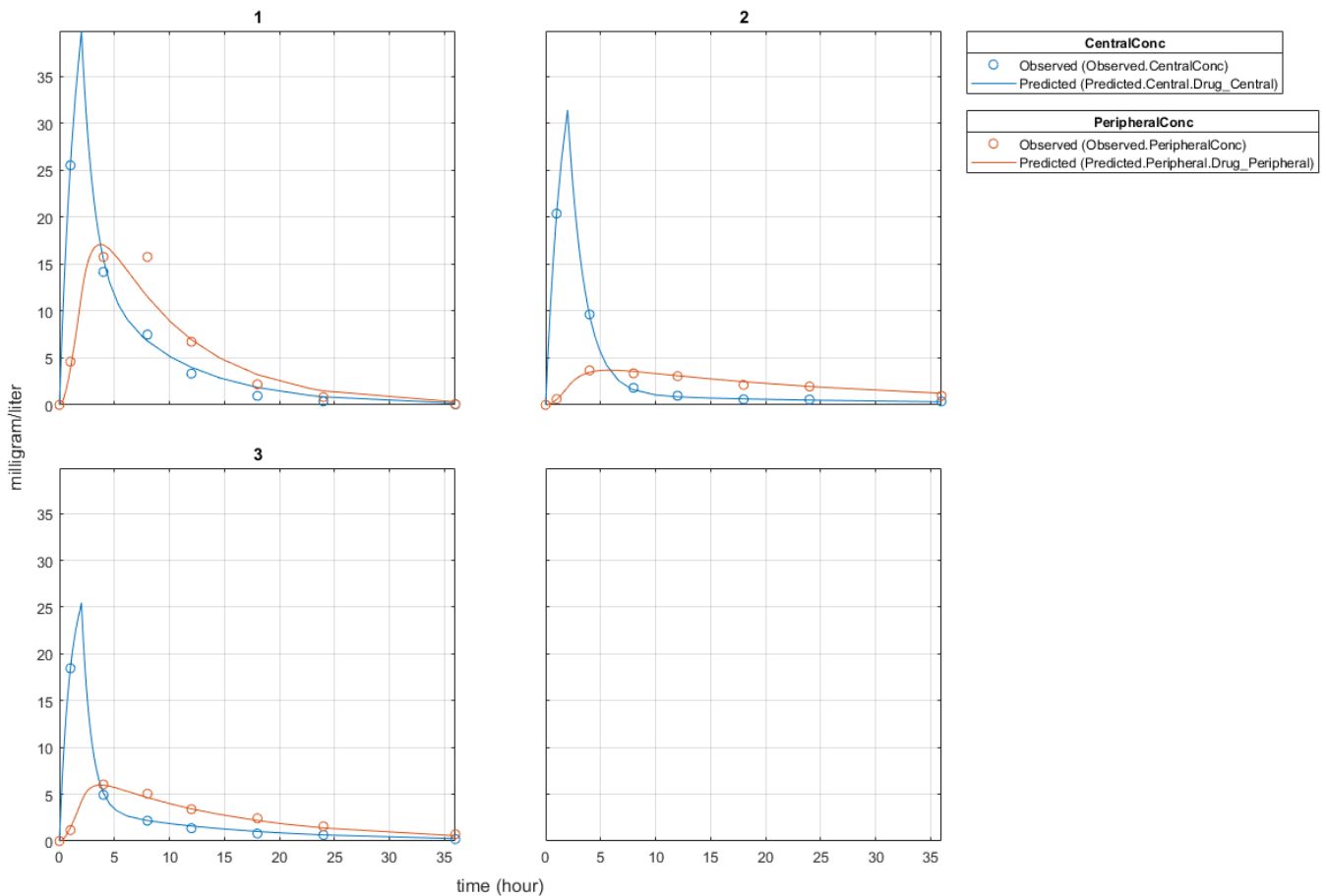

Generate a plot of the residuals over time to compare the pooled and unpooled fit results. The figure indicates unpooled fit residuals are smaller than those of the pooled fit, as expected. In addition to comparing residuals, other rigorous criteria can be used to compare the fitted results.

```

t = [gData.Time;gData.Time];
res_pooled = vertcat(pooledFit.R);
res_pooled = res_pooled(:);
res_unpooled = vertcat(unpooledFit.R);
    
```

```

res_unpooled = res_unpooled(:);
figure;
plot(t,res_pooled,"o",MarkerFaceColor="w",markerEdgeColor="b")
hold on
plot(t,res_unpooled,"o",MarkerFaceColor="b",markerEdgeColor="b")
refl = refline(0,0); % A reference line representing a zero residual
title("Residuals versus Time");
xlabel("Time");
ylabel("Residuals");
legend(["Pooled","Unpooled"]);

```

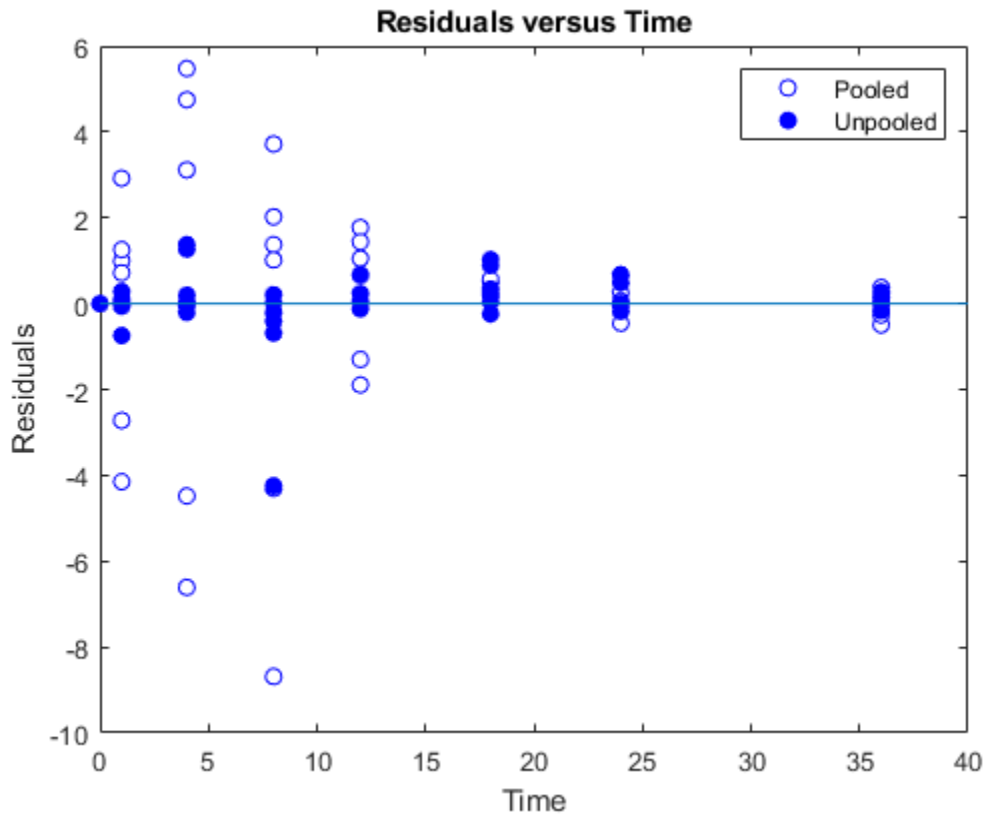

As illustrated, the unpooled fit accounts for variations due to the specific subjects in the study, and, in this case, the model fits better to the data. However, the pooled fit returns population-wide parameters. As an alternative, if you want to estimate population-wide parameters while considering individual variations, you can perform nonlinear mixed-effects (NLME) estimation by setting `problem.FitFunction` to `sbiofitmixed`.

```

problem.FitFunction = "sbiofitmixed";
NLMEResults = fit(problem);

```

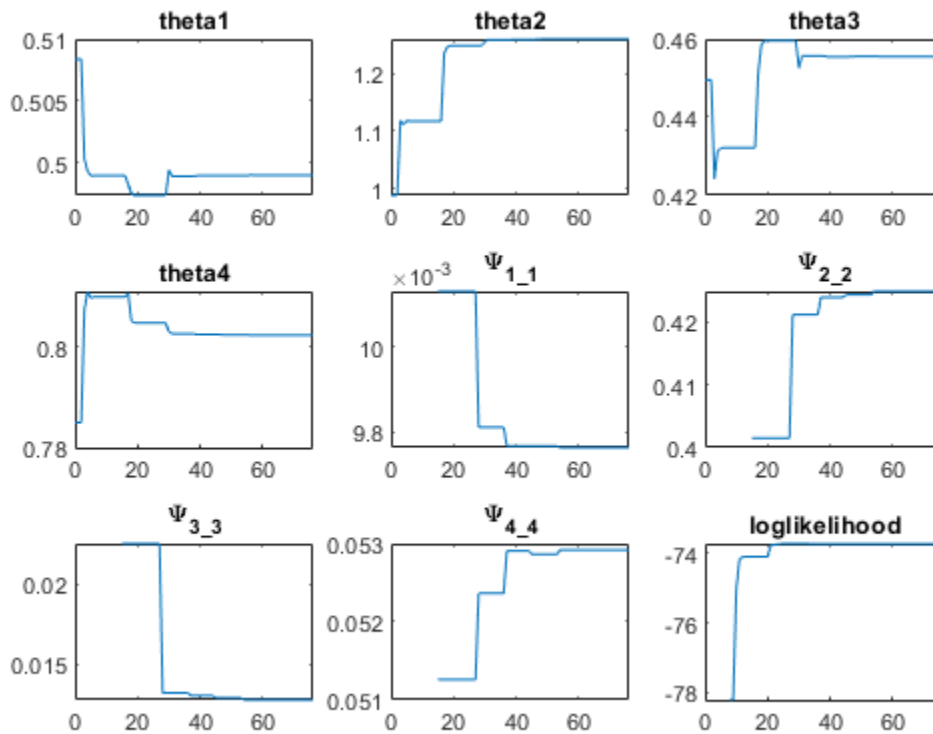

Display the estimated parameter values.

```
NLMEResults.IndividualParameterEstimates
```

```
ans=12x3 table
```

Group	Name	Estimate
1	{'Central' }	1.4623
1	{'Peripheral'}	1.5306
1	{'Q12' }	0.4587
1	{'Cl_Central'}	0.53208
2	{'Central' }	1.783
2	{'Peripheral'}	6.6623
2	{'Q12' }	0.3589
2	{'Cl_Central'}	0.8039
3	{'Central' }	1.7135
3	{'Peripheral'}	4.2844
3	{'Q12' }	0.54895
3	{'Cl_Central'}	1.0708

Plot the fitted results.

```
plot(NLMEResults);
```

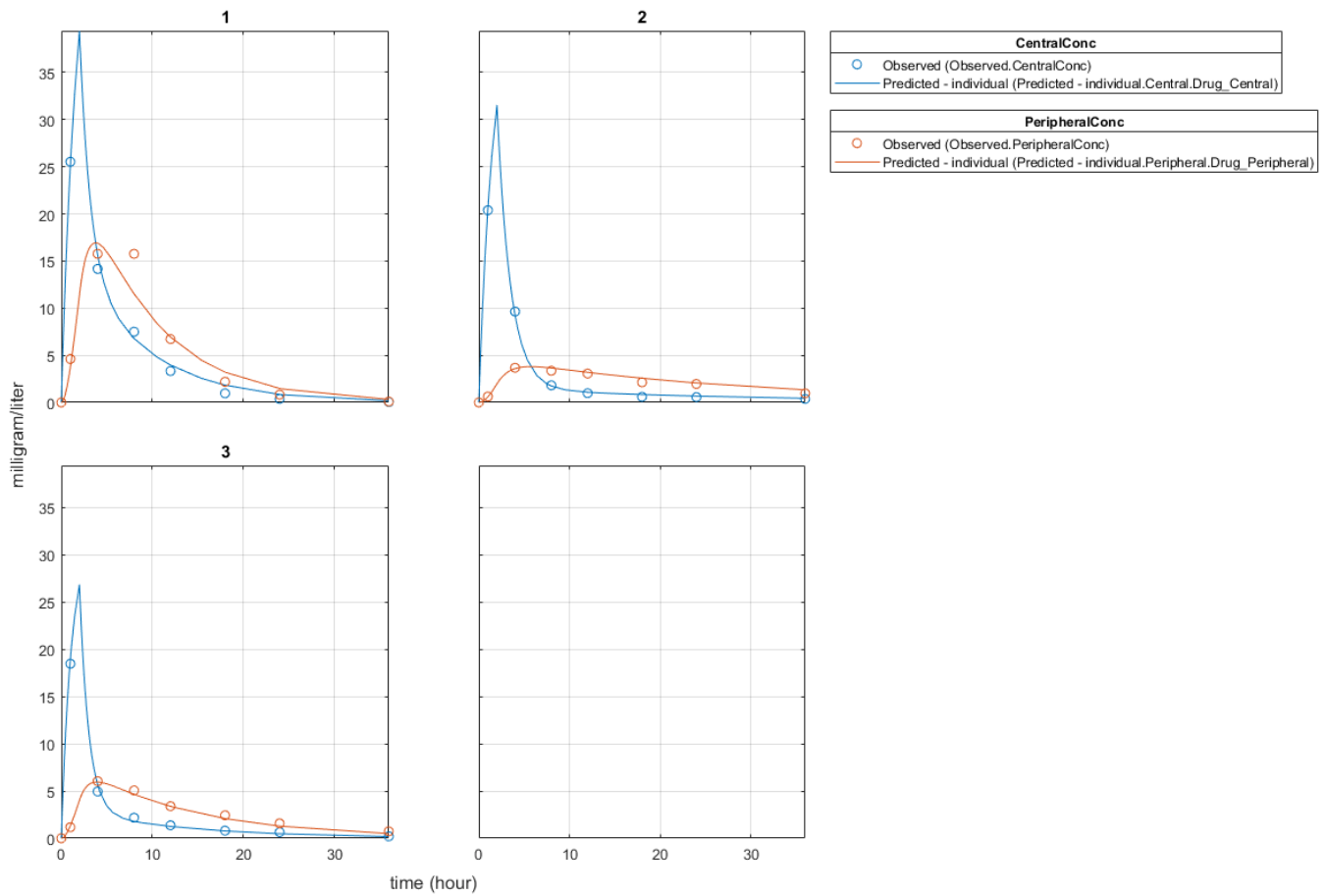

Plot the conditional weighted residuals (CWRES) and individual weighted residuals (IWRES) of model predicted values.

```
plotResiduals(NLMEResults, 'predictions')
```

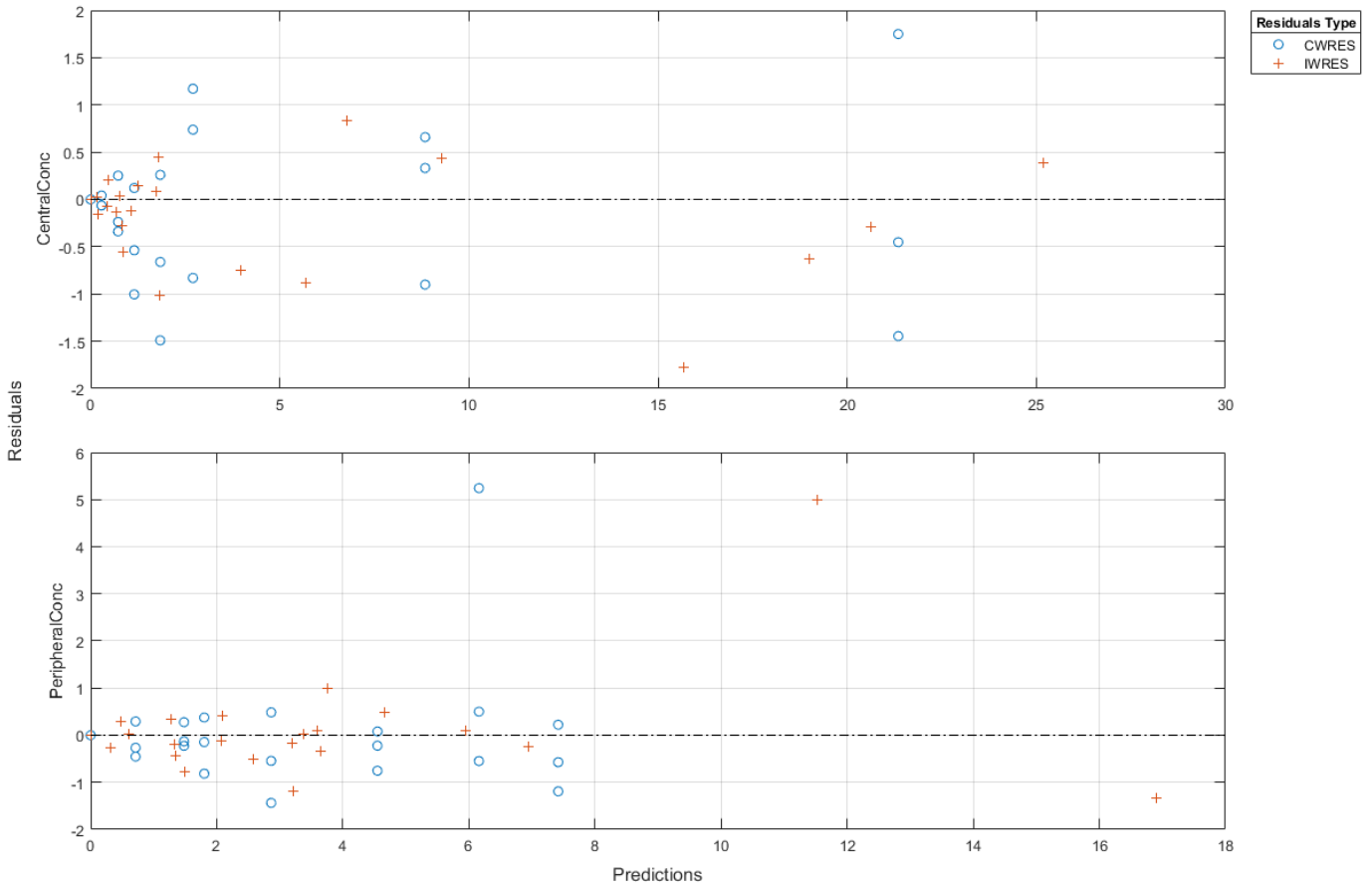

See Also
fitproblem

Pharmacokinetic Modeling

- “Pharmacokinetic Modeling Functionality” on page 5-2
- “Importing Data — Supported Files and Data Types” on page 5-5
- “Importing Data” on page 5-12
- “Create Pharmacokinetic Models” on page 5-14

Pharmacokinetic Modeling Functionality

In this section...

“Overview” on page 5-2

“How SimBiology Supports Pharmacokinetic Modeling” on page 5-2

“Pharmacokinetic Modeling Examples” on page 5-3

“Acknowledgements: Tobramycin Data Set” on page 5-3

Overview

SimBiology software extends the MATLAB computing environment for analyzing pharmacokinetic (PK) data using models. The software lets you do the following:

- Create models — Use a model construction wizard. Alternatively, extend any model with pharmacodynamic (PD) model components, or build higher fidelity models. See “Model” on page 5-2 for more information.
- Fit data — Fit nonlinear, mixed-effects models to data, and estimate the fixed and random effects, or fit the data using nonlinear least squares. For more information, see “Analyze Data Using Models” on page 5-2.
- Generate diagnostic plots — For more information, see “Analyze Data Using Models” on page 5-2.

The software lets you work with different model structures, thus letting you try multiple models to see which one produces the best results.

How SimBiology Supports Pharmacokinetic Modeling

Import and Work with Data

You can import tabular data into the SimBiology Model Analyzer or the MATLAB Workspace. The supported file types are `.xls`, `.csv`, and `.txt`. You can specify that the data is in a NONMEM[®] formatted file. The import process interprets the columns according to the NONMEM definitions. For details, see “Importing Data” on page 5-12.

Model

SimBiology provides an extensible modeling environment. You can do any of the following:

- Create a PK model using a model construction wizard to specify the number of compartments, the route of administration, and the type of elimination.
- Extend any model with pharmacodynamic (PD) model components, or build higher fidelity models.
- Build or load your own SimBiology, or SBML model.

For more information, see “What is a SimBiology Model?” on page 2-2.

Analyze Data Using Models

Perform both individual and population fits to grouped longitudinal data:

- Individual fit — Fit data using nonlinear least-squares method, specify parameter transformations, estimate parameters, and calculate residuals and the estimated coefficient covariance matrix. For a command line workflow, see “Fitting Workflow for sbiofit” on page 4-40. For an app workflow, see “Calculate NCA Parameters and Fit Model to PK/PD Data Using SimBiology Model Analyzer App” on page 1-77.
- Population fit — Fit data, specify parameter transformations, and estimate the fixed effects and the random sources of variation on parameters using nonlinear mixed-effects models. For a command line workflow, see “Nonlinear Mixed-Effects Modeling Workflow” on page 4-30.
- Population fit using a stochastic algorithm — Fit data, specify parameter transformations, and estimate the fixed effects and the random sources of variation on parameters, using the Stochastic Approximation Expectation-Maximization (SAEM) algorithm. SAEM is more robust with respect to starting values. This functionality relaxes assumption of constant error variance. Specify `nlfmefitsa` as the estimation function name when you run `sbiofitmixed`.

In addition, you can turn on the ProgressPlot on page 4-45 option to get the live feedback on the status of parameter estimation.

Pharmacokinetic Modeling Examples

The following examples show how to estimate pharmacokinetic parameters at the command line.

- “Modeling the Population Pharmacokinetics of Phenobarbital in Neonates” on page 4-153
- “Fit One-Compartment Model to Individual PK Profile” on page 4-52
- “Fit a Two-Compartment Model to PK Profiles of Multiple Individuals” on page 4-71
- “Estimate Category-Specific PK Parameters for Multiple Individuals” on page 4-58
- “Perform Hybrid Optimization Using sbiofit” on page 4-67

For an app example, see “Calculate NCA Parameters and Fit Model to PK/PD Data Using SimBiology Model Analyzer App” on page 1-77.

Acknowledgements: Tobramycin Data Set

Acknowledgements for data in the `tobramycin.txt` file are located in the `/matlab/toolbox/simbio/simbiodemofolder`. Data set is provided by Dr. Leon Aarons (`laarons@fsl.pa.man.ac.uk`).

The data in the `tobramycin.txt` file were downloaded from the Web site of the Resource Facility for Population Kinetics <http://depts.washington.edu/rfpk/service/datasets/index.html> (no longer active). Funding source: NIH/NIBIB grant P41-EB01975.

The original data set was modified as follows:

- Header comments were removed.
- The file was converted to a tab-delimited format.
- Missing values in the HT column were denoted with "." instead of `100000000.000`.

References

- [1] Original Publication: Aarons L, Vozech S, Wenk M, Weiss P, and Follath F. “Population pharmacokinetics of tobramycin.” *Br J Clin Pharmacol*. 1989 Sep;28(3):305-14.

See Also

`sbiofit` | `sbiofitmixed`

More About

- “Nonlinear Regression”
- “Nonlinear Mixed-Effects Modeling”

Importing Data — Supported Files and Data Types

In this section...

“Supported Files and Data Types” on page 5-5

“Create Data File with SimBiology Definitions” on page 5-5

“Support for Importing NONMEM Formatted Files” on page 5-7

“Supported Table Column Types in SimBiology Model Analyzer” on page 5-11

“Support for Importing Multidimensional SimData to SimBiology Model Analyzer” on page 5-11

Supported Files and Data Types

You can import tabular data to the **SimBiology Model Analyzer** app or to the MATLAB Workspace. The supported file types are Excel files (.xls, .xlsx), text files (.csv, .txt), and SAS® XPORT files (.xpt). You can also specify that the data is in a NONMEM formatted file. The import process interprets the columns according to the NONMEM definitions. For more information see “Support for Importing NONMEM Formatted Files” on page 5-7.

Note If your data set contains dosing information that is infusion data, the data set must contain the rate and not an infusion duration.

Unit Conversion

Regardless of whether unit conversion functionality is on or off, dosing in the data file must be expressed in amounts (or as amount/time for infusion rate). By default **Unit Conversion** is off, so you must ensure that units for the data are consistent with each other. If you want to turn on unit conversion, see “Unit Conversion for Imported Data” on page 5-19 .

Create Data File with SimBiology Definitions

If you are creating a file containing time course data that you want to import into SimBiology for fitting, create the data file with the following columns:

- Group column — Specify text, numeric, or categorical values. For instance, you can use this column to group multiple individuals into separate groups. You can then use this grouping or categorical information for hierarchical fits on page 4-58. This column is optional.
- ID column — Specify text, numeric, or categorical values. The rows in the file that have the same ID column value are for the same individual. This column is optional if the measurement data comes from just one individual.
- Time column — Specify monotonically increasing positive values within each ID that define the time of the dose, observation measurements, and covariate measurements.
- Zero or more dosing columns — Create one dosing column for each compartment being dosed. In each column, specify positive values representing dose amounts that are added to a species. Use NaN (not a number) to specify that no dose was applied at the specified time. In other words, specify the dose amount as NaN when an observation was recorded but no dose was applied.
- Zero or more rate columns — Specify positive values, zero, or NaN. Zero specifies an infinite rate and NaN specifies that no rate applies. The rate column is associated with a dosing column and

defines the rate at which the dose is administered. For example, if you can specify an infusion dose in the `Dose1` column, specify its rate in the `Rate1` column.

- Zero or more observation columns — Specify numeric values or `NaN`. `NaN` values define that no observation was recorded at the specified time. Use `NaN` for times when a dose was applied but no observation was recorded. You can specify one observation value at a particular time for each ID. When you have replicates, specify multiple observation values for the same time point by adding more rows with the same time value. For an example, see rows 2 and 3 in the screen shot below, where `CentralConc` has two measurements at time = 0.
- Zero or more covariate columns — Specify text, numeric, or categorical values, or `NaN`. Each value defines the covariate value at the specified time. `NaN` values indicate that no covariate observation was recorded at the specified time. SimBiology supports only covariates that are not time varying. For instance, see the `Sex` and `Age` columns in the example below. For an example that shows how to use categories for fitting, see “Estimate Category-Specific PK Parameters for Multiple Individuals” on page 4-58. You can also create variants from covariate columns. For details, see `createVariants`.

A screen shot of a sample data file follows.

	A	B	C	D	E	F	G	H	I	J
1	Group	ID	Time	CentralConc	PeripheralConc	Sex	Age	Dose1	Dose2	Rate2
2	1	1	0	83.378	0.0685	Female	Old	100	50	0.5
3	1	1	0	85.000	0.0685	Female	Old	NaN	NaN	NaN
4	1	1	1	31.019	29.6614	Female	Old	NaN	NaN	NaN
5	1	1	4	6.488	11.1966	Female	Old	NaN	NaN	NaN
6	1	1	8	1.163	2.0693	Female	Old	NaN	NaN	NaN
7	1	1	12	0.075	0.4011	Female	Old	NaN	NaN	NaN
8	1	1	18	0.090	0.0463	Female	Old	NaN	NaN	NaN
9	1	1	24	0.018	0.0000	Female	Old	NaN	NaN	NaN
10	1	1	36	0.000	0.0000	Female	Old	NaN	NaN	NaN
11	1	2	0	49.992	NaN	Female	Young	100	50	0.5
12	1	2	1	25.276	NaN	Female	Young	NaN	NaN	NaN
13	1	2	4	7.108	NaN	Female	Young	NaN	NaN	NaN
14	1	2	8	2.711	NaN	Female	Young	NaN	NaN	NaN
15	1	2	12	1.050	NaN	Female	Young	NaN	NaN	NaN
16	1	2	18	0.294	NaN	Female	Young	NaN	NaN	NaN
17	1	2	24	0.017	NaN	Female	Young	NaN	NaN	NaN
18	1	2	36	0.000	0.0122	Female	Young	NaN	NaN	NaN
19	1	3	0	NaN	NaN	Male	Young	100	50	0.5
20	1	3	1	26.269	23.3222	Male	Young	NaN	NaN	NaN
21	1	3	4	14.365	16.4610	Male	Young	NaN	NaN	NaN
22	1	3	8	7.342	8.5099	Male	Young	NaN	NaN	NaN
23	1	3	12	3.695	4.3110	Male	Young	NaN	NaN	NaN
24	1	3	18	1.351	1.5315	Male	Young	NaN	NaN	NaN
25	1	3	24	0.458	0.5187	Male	Young	NaN	NaN	NaN
26	1	3	36	0.187	0.1044	Male	Young	NaN	NaN	NaN

You can download the sample Excel file from the following location: *matlabroot/examples/simbio/data/sample_data_simbiology.xlsx*. *matlabroot* is the root directory where you installed MATLAB. You can also enter *matlabroot* at the command line to see the file path of the root directory.

Support for Importing NONMEM Formatted Files

You can specify that the data is in a NONMEM formatted file. The following table highlights the interpretation of this data in SimBiology software.

Column Header	Interpretation										
ID	Text (character vector), numeric, or categorical values that identify the record or group. The import process assumes that contiguous data with the same value contains data from one individual. If the data contains non-contiguous references to the same value, the import process assigns the second ID encountered an indexed value derived from the group first encountered. For example, if the ID column contains [1 1 1 2 2 2 1 1 1], the IDs assigned are 1, 2, 1_1.										
TIME	<p>Monotonically increasing positive values within each group, indicating time of observation or dose or text (character vector). The data file can specify clock (2:30 as a character vector) or decimal values (6.25). The import process assigns a value of 0 to the first TIME value in the data file. The import process assigns subsequent values relative to the first value.</p> <p>The following table is an example of how the import process interprets the clock values as decimal values.</p> <table border="1" data-bbox="652 867 1472 1087"> <thead> <tr> <th data-bbox="652 867 1062 909">Original Clock Values</th> <th data-bbox="1062 867 1472 909">Imported Values</th> </tr> </thead> <tbody> <tr> <td data-bbox="652 909 1062 951">10:00</td> <td data-bbox="1062 909 1472 951">0</td> </tr> <tr> <td data-bbox="652 951 1062 993">10:30</td> <td data-bbox="1062 951 1472 993">0.5</td> </tr> <tr> <td data-bbox="652 993 1062 1035">11</td> <td data-bbox="1062 993 1472 1035">1</td> </tr> <tr> <td data-bbox="652 1035 1062 1077">12:30</td> <td data-bbox="1062 1035 1472 1077">2.5</td> </tr> </tbody> </table> <p>If the data file also contains a DATE column, the import process uses it with the TIME column in calculating the relative TIME values. The column cannot contain Inf.</p>	Original Clock Values	Imported Values	10:00	0	10:30	0.5	11	1	12:30	2.5
Original Clock Values	Imported Values										
10:00	0										
10:30	0.5										
11	1										
12:30	2.5										

Column Header	Interpretation
DATE, DAT1, DAT2, or DAT3	<p>Defines the day of the observation or the dose. The column can contain the month as a number (9) or a character vector (Sep). Specify date in the following formats:</p> <ul style="list-style-type: none"> • DATE — The column can specify month/day/year or month-day-year. If you specify two numbers, the import process assumes they are month and day. You can use either / or - as a separator. • DAT1 — The column can specify day/month/year or day-month-year. If you specify two numbers, the import process assumes they are day and month. • DAT2 — The column can specify year/month/day or year-month-day. If you specify two numbers, the import process assumes they are month and day. • DAT3 — The column can specify year/day/month or year-day-month. If you specify two numbers, the import process assumes they are day and month. <hr/> <p>Note</p> <ul style="list-style-type: none"> • If you specify only one number, the import process assumes it is the day. • You can omit the year or specify 1, 2, 3, or 4 digits. If you specify two-digit years, it is assumed to be in the 1900s. • If the data has the DAT1, DAT2, or DAT3 column, set the DateLabel property of a NMFileDef object accordingly using sbionmfiledef. Then specify the object as the second input argument when you run sbionmimport.
DV	Numeric value of an observation. Column cannot contain Inf or -Inf.
MDV	<p>Defines whether a row describes an observation:</p> <ul style="list-style-type: none"> • Row contains 0 — Observation event • Row contains 1 — Not an observation event

Column Header	Interpretation
EVID	<p>Defines the type of event described for the row in the record:</p> <ul style="list-style-type: none"> • 0 — Observation event; row contains an observed value. • 1 — Dose event; row describes a dose. • 2 — Other event; row describes some other event such as measurement of a covariate. <p>If a column contains values for dose, but EVID is not 1, the import process ignores the value. You see a warning and the value is ignored.</p> <p>If EVID is set to 2, then only those specified row data are imported as covariate data. However, if you have an EVID column as well as one or more covariate columns, but do not specify a value of 2 anywhere in the EVID column, then SimBiology imports all the row data as covariate values.</p> <p>The import process does not support values 3 and 4. You see a warning and the value is ignored.</p>
CMT	<p>Indicates which compartment is used for observation value or for dose received. The interpretation also depends on EVID:</p> <ul style="list-style-type: none"> • Observation event (EVID = 0) — CMT column indicates which compartment was used for observation value. • Dose Event (EVID = 1) — CMT column indicates which compartment received the dose. <p>Note SimBiology numbers compartments starting with 1, while NONMEM numbers them starting with 0. For instance, if a NONMEM data file contains doses and measurements for CMT = 0, SimBiology generates data columns named Dose1 and Response1 respectively.</p>
AMT	Positive number indicating dose. 0 or NaN specifies no dose administered. The column cannot contain Inf.
RATE	Positive number indicating rate of infusion. 0 specifies an infinite rate (equivalent to a bolus dose), and NaN specifies no rate. The column cannot contain Inf.
II	Positive number defining the time between doses.
ADDL	When the data specifies a number of identical serial doses at specific intervals (defined by II), ADDL specifies the number of doses in the series excluding the initial dose. If the data specifies II but not ADDL, then SimBiology assumes that the dosing occurs for the duration of that data record.

Unsupported NONMEM Definitions

The import process does not support (and therefore ignores) the rows containing the following values or definitions:

- EVID values 3 and 4
- SS column for specifying steady state doses
- PCMT column to define whether to compute a prediction for the row
- CALL column for calling the ERROR or the PK subroutine
- If rate is specified as being less than zero, it is assumed to be zero

Supported Table Column Types in SimBiology Model Analyzer

When you are importing data from a table using **SimBiology Model Analyzer**, the app supports the following column data types: double, char, string, cell array of character vectors, categorical, duration, logical, and datetime.

Support for Importing Multidimensional SimData to SimBiology Model Analyzer

When you import a multidimensional `SimData` array to the app, the app flattens the `SimData` array and uses a single index (linear indexing) in the corresponding datasheet. For example, if you import a 2x2x2 `SimData` array *A*, the app creates a datasheet with 8 groups (one for each `SimData` object), indexing from 1 to 8. The app still displays the original size of the `SimData` array in the **Browser**.

See Also

SimBiology Model Analyzer | `sbiofit` | `sbiofitmixed`

Importing Data

In this section...

“Import Data from Files” on page 5-12

“Importing Data from NONMEM-Formatted Files” on page 5-12

“Other Resources for Importing Data” on page 5-13

Import Data from Files

Use `table` to store tabular data that you can use later in fitting and analysis at the command line. Use `readtable` to import data without NONMEM interpretation of column headers. The `readtable` function lets you use name-value pair arguments in which you can specify options such as the type of delimiter and whether the first row contains header names. If you want to use the data for fitting using `sbiofit` or `sbiofitmixed`, convert it to a `groupedData` format using `groupedData`.

To prepare the data file for import, remove any comments that are present at the beginning of the file.

For example:

```
% Text files
data = readtable('tobramycin.txt');
% Text files with . in place of missing values
data = readtable('tobramycin.txt', 'TreatAsEmpty', '.');
```

For details on how to format a data file for fitting, see “Create Data File with SimBiology Definitions” on page 5-5.

Importing Data from NONMEM-Formatted Files

Use the `sbionmimport` function to import data from NONMEM formatted files. To import the data without NONMEM interpretation of column headers, see “Import Data from Files” on page 5-12.

To prepare the data file for import, remove any comments that are present at the beginning of the file and select one of the following methods to import your data:

- If the data file contains only the column header values shown in “Support for Importing NONMEM Formatted Files” on page 5-7, use the syntax shown in the following example:

```
filename = 'C:\work\datafiles\dose.xls';
ds = sbionmimport(filename);
```

- If the data file has column header labels different from the table shown in “Support for Importing NONMEM Formatted Files” on page 5-7 and you want to apply NONMEM interpretation of headers:

- 1 Create a NONMEM file definition object. This object lets you define what the column headers in the data file mean in SimBiology. In the following example, the column containing response values is CP, whereas in NONMEM formatted files the column is labelled DV.

To use the tobramycin data set [1] on page 5-3, create a NONMEM file definition object and define the following:

```
def = sbionmfiledef;
def.DoseLabel = 'DOSE';
def.GroupLabel = 'ID';
def.TimeLabel = 'TIME';
def.DependentVariableLabel = 'CP';
def.MissingDependentVariableLabel = 'MDV';
def.EventIDLabel = 'EVID';
def.ContinuousCovariateLabels = {'WT', 'HT', 'AGE', 'SEX', 'CLCR'};
```

Your file can contain any name for column headings. See `sbionmfiledef` for the list of properties you can configure in the NONMEM file definition object.

- 2 Use the `sbionmimport` function to import your data file with the column header definitions as specified in the NONMEM file definition object. For example, browse to `matlabroot/toolbox/simbio/simbiodemodemos/` (where `matlabroot` is the folder where MATLAB is installed).

```
[data, pkDataObject] = sbionmimport('tobramycin.txt', def, ...
    'TreatAsEmpty', '.');
```

This example shows you how to obtain the PKData object, `PKDataObj`, while importing, since you will use the PKData object in fitting the model later.

The `sbionmimport` function accepts property-name-value pairs accepted by `dataset`. For example, if the data set does not contain column headers, use `'ReadVarNames', false` to specify that `sbionmimport` should read values from the first row of the file.

For information about creating a model to fit the data, see “Create a Pharmacokinetic Model Using the Command Line” on page 5-19.

Other Resources for Importing Data

For detailed information about supported data formats and the functions for importing data into the MATLAB Workspace, see “Supported File Formats for Import and Export”.

You also can import data using the MATLAB Import Wizard to import data as text files (such as `.txt` and `.dat`), MAT-files, and spreadsheet files, (such as `.xls`).

The MATLAB Import Wizard processes the data source. The wizard recognizes data delimiters, as well as row or column headers, to facilitate the process of data selection and importation into the MATLAB Workspace. You can import the data to the SimBiology Model Analyzer app from the MATLAB Workspace.

See Also

`sbionmimport` | `groupedData` | `sbionmfiledef` | `readtable`

Related Examples

- “Importing Data — Supported Files and Data Types” on page 5-5
- “Create Data File with SimBiology Definitions” on page 5-5

Create Pharmacokinetic Models

In this section...

“Ways to Create or Import Pharmacokinetic Model” on page 5-14

“How SimBiology Models Represent Pharmacokinetic Models” on page 5-14

“Dosing Types” on page 5-15

“Elimination Types” on page 5-17

“Intercompartmental Clearance” on page 5-18

“Unit Conversion for Imported Data” on page 5-19

“Create a Pharmacokinetic Model Using the Command Line” on page 5-19

Ways to Create or Import Pharmacokinetic Model

To start modeling, you can:

- Create a PK model using a model construction wizard that lets you specify the number of compartments, the route of administration, and the type of elimination.
- Extend any model to build higher fidelity models.
- Build or load your own model. Load a SimBiology project or SBML model.

How SimBiology Models Represent Pharmacokinetic Models

The following figure compares a model as typically represented in pharmacokinetics with the same model shown in the SimBiology model diagram. For this comparison, assume that you are modeling administration of a drug using a two-compartment model with any dosing input and linear elimination kinetics. (The model structure remains the same with any dosing type.)

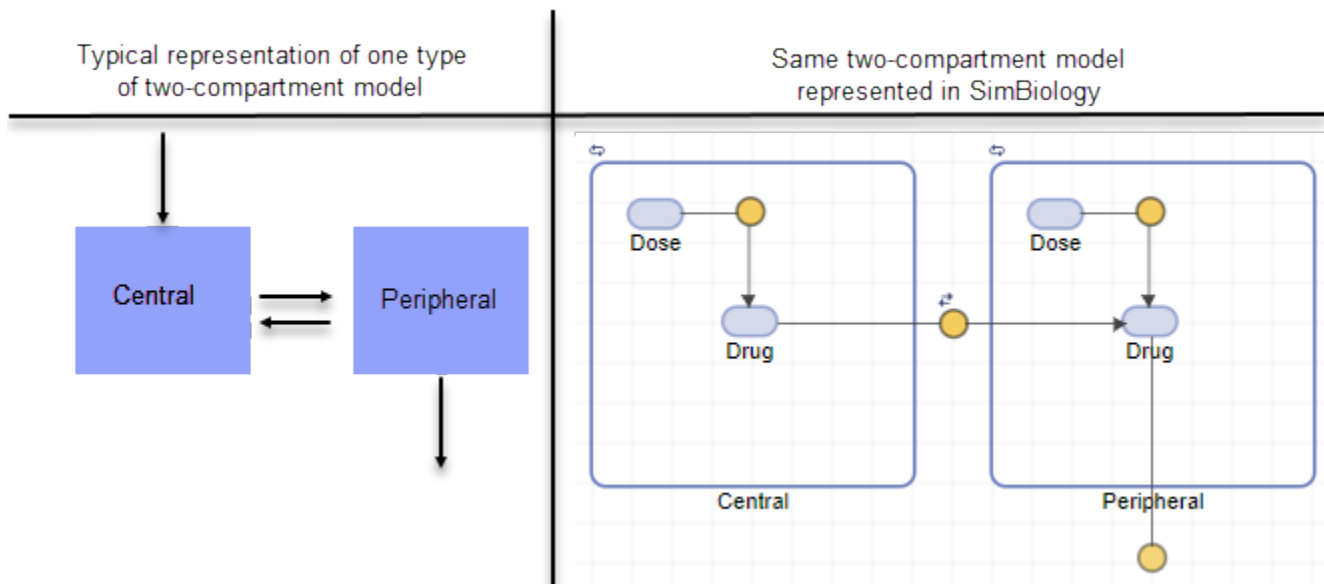

Note the following:

- SimBiology represents the concentration or amount of a drug in a given compartment or volume by a species *object* contained within the compartment.
- SimBiology represents the exchange or flow of the drug between compartments and the elimination of the drug by reactions.
- SimBiology represents intercompartmental clearance by a parameter (Q) which specifies the clearance between the compartments.
- SimBiology drives the dosing schedule with a combination of species (Drug and/or Dose) and reactions (Dose -> Drug), depending on whether the administration into the compartment follows bolus, zero-order, infusion, or first-order dosing kinetics. For more information on the components added and parameters estimated, see “Dosing Types” on page 5-15.

You can also view this model as a regression function, $y = f(k, u)$, where y is the predicted value, given values of an input u , and parameter values k . In SimBiology the model represents f , and the model is used to generate a regression function if y , k , and u are identified in the model.

Dosing Types

When creating models, SimBiology creates the following model components for each compartment in the model, regardless of the dosing type:

- Two species (Drug_CompartmentName and Dose_CompartmentName) for each compartment.
- A reaction (Dose_CompartmentName -> Drug_CompartmentName) for each compartment, governed by mass action kinetics.
- A parameter (ka_CompartmentName) for each compartment, representing the absorption rate of the drug when absorption follows first-order kinetics. This is the forward rate parameter for the Dose_CompartmentName -> Drug_CompartmentName reaction.
- A parameter (Tk0_CompartmentName) for each compartment, representing the duration of drug absorption when absorption follows zero-order kinetics.
- A parameter (TLag_CompartmentName) for each compartment, representing the time lag for any dose that targets that compartment and also that is specified as having a time lag.

For dosing types that have a fixed infusion or absorption duration (infusion and zero-order), you can use overlapping doses. The doses are additive.

The following table describes the dosing types, the default parameters to estimate, and lists the model components created and used for dosing.

Dosing Type	Description	SimBiology Model Components Used	Default Parameters to Estimate
' ' (empty character vector)	No dose	The species (Drug_CompartmentName) in each compartment	None

Dosing Type	Description	SimBiology Model Components Used	Default Parameters to Estimate
SimBiology Model Builder app — bolus Command line — Bolus	<p>Assumes that the drug amount is increased instantly at the dose time.</p> <p>In the SimBiology model, the initial concentration of the drug is based on dose amount and volume of the compartment containing the drug.</p>	The species (Drug_CompartmentName) in each compartment	None
SimBiology Model Builder app — infusion Command line — Infusion	<p>Assumes that the infused drug amount increases at a constant known absorption (or infusion) rate over a known duration.</p> <p>The imported data set must contain the rate and not an infusion duration. SimBiology uses this information to change the species concentration at the constant rate over the duration specified in the data set.</p>	The species (Drug_CompartmentName) in each compartment	None
SimBiology Model Builder app — zero-order Command line — ZeroOrder	Assumes that the drug is added at a constant rate over fixed, but unknown duration.	<ul style="list-style-type: none"> The species Drug_CompartmentName in each compartment The parameter (Tk0_CompartmentName) in each compartment that has zero-order dosing. This parameter represents the duration of drug absorption 	Tk0_CompartmentName (absorption duration)

Dosing Type	Description	SimBiology Model Components Used	Default Parameters to Estimate
SimBiology Model Builder app — first-order Command line — FirstOrder	Assumes that the rate at which the drug is absorbed is not constant. In the SimBiology model, absorption rate is assumed to be governed by mass-action kinetics.	<ul style="list-style-type: none"> A species (Dose_CompartmentName) representing the dose amount before it is absorbed A species (Drug_CompartmentName) for each compartment A parameter (ka_CompartmentName) representing the absorption rate of the drug A MassAction reaction (Dose_CompartmentName → Drug_CompartmentName) with forward rate parameter (ka_CompartmentName) 	ka_CompartmentName (absorption rate)

Elimination Types

Elimination Type	Description	SimBiology Model Components Created	Default Parameters to Estimate
SimBiology Model Builder app — Linear {Elimination Rate, Volume} Command line — 'linear'	Assumes simple mass-action kinetics in the elimination of the drug. In the SimBiology model, elimination is specified by mass-action kinetics with the elimination rate constant specified by the forward rate parameter (ke).	<ul style="list-style-type: none"> A parameter representing the elimination rate (ke_CompartmentName) A MassAction reaction (drug → null) with forward rate parameter (ke_CompartmentName) specific to the compartment 	<ul style="list-style-type: none"> Compartment volume (Capacity property) Elimination rate constant (ke_CompartmentName) Inter-compartmental clearance (Q) when there is more than one compartment. See "Intercompartmental Clearance" on page 5-18.

Elimination Type	Description	SimBiology Model Components Created	Default Parameters to Estimate
<p>SimBiology Model Builder app — Linear {Clearance, Volume}</p> <p>Command line — 'linear-clearance'</p>	<p>Assumes simple mass-action kinetics in the elimination of the drug. In the SimBiology model, similar to Linear {Elimination Rate, Volume}. But, in addition, this option lets you specify the model in terms of clearance (Cl) where, $Cl = ke * volume$.</p>	<ul style="list-style-type: none"> • A parameter representing the clearance (Cl_CompartmentName) • A parameter representing the elimination rate constant (ke_CompartmentName) • An InitialAssignment rule that initializes ke_CompartmentName based on the initial values for Cl_CompartmentName and compartment volume • A MassAction reaction (drug -> null) with forward rate parameter (ke_CompartmentName) 	<ul style="list-style-type: none"> • Compartment volume (Capacity property) • Clearance (Cl_CompartmentName) • Inter-compartmental clearance (Q) when there is more than one compartment. <p>See "Intercompartmental Clearance" on page 5-18.</p>
<p>SimBiology Model Builder app — Enzymatic (Michaelis-Menten)</p> <p>Command line — 'enzymatic'</p>	<p>Assumes that elimination is governed by Michaelis-Menten kinetics.</p>	<ul style="list-style-type: none"> • Parameter representing the Michaelis constant, (Km_CompartmentName) • A parameter for maximum velocity (Vm_CompartmentName) • A reaction with Michaelis-Menten kinetics (drug -> null), with kinetic law parameters Vm_CompartmentName and Km_CompartmentName 	<ul style="list-style-type: none"> • Compartment volume (Capacity property) • Parameter (Km_CompartmentName) • Parameter (Vm_CompartmentName) • Inter-compartmental clearance (Q) when there is more than one compartment. <p>See "Intercompartmental Clearance" on page 5-18</p>

Intercompartmental Clearance

The compartments created when you generate a SimBiology model form a chain and each pair of linked compartments are connected by a transport reaction similar to linear elimination. The addition of two compartments, C1 and C2, generates a reversible mass-action reaction $C1.Drug_{C1} \leftrightarrow C2.Drug$. The forward rate parameter is the compartmental clearance, Q_{12} , divided by the volume of C1. The reverse rate parameter is Q_{12} , divided by the volume of C2.

The process of adding each pair of compartments in the chain C_m and C_n generates the following model components:

- A parameter Q_{mn} representing the compartmental clearance between those two compartments. This parameter is added to the list of parameters to be estimated (Estimated property of PKModelMap object).
- A parameter (k_{mn}) representing the rate of transfer of the drug from C_m to C_n , where $k_{mn} = Q_{mn}/V_m$.
- A parameter (k_{nm}) representing the rate of C_n to C_m , where $k_{nm} = Q_{mn}/V_n$.
- A reversible mass-action reaction between the two compartments, $C_m.\text{Drug}_{C_m} \leftrightarrow C_n.\text{Drug}_{C_n}$, with forward rate parameter k_{mn} , and reverse rate parameter k_{nm} .
- An initial assignment rule that initializes the value of the parameter k_{mn} , based on the initial values for C_m and Q_{mn} .
- An initial assignment rule that initializes the value of the parameter k_{nm} , based on the initial values for C_n and Q_{mn} .

Unit Conversion for Imported Data

Unit conversion converts the matching physical quantities to one consistent unit system in order to resolve them. This conversion is in preparation for correct simulation, but SimBiology returns the physical quantities in the model in units that you specify.

Regardless of whether unit conversion is on or off, you must express dosing data in amount. By default, **Unit Conversion** is off, so you must ensure that units for the data and the model are consistent with one another. If **Unit Conversion** is on, you must specify units.

Parameters in the model have default units. If unit conversion is on, you can change the units as long as the dimensions are consistent. These default units, which you might use to specify the values for the initial guess, are as follows.

Physical Quantity or Model Parameter	Unit
Central or peripheral compartment volume (<i>Central</i> or <i>Peripheral</i>)	liter
First-order elimination rate (<i>ke</i>)	1/second
Michaelis constant (<i>Km</i>)	milligram/liter
Maximum reaction-velocity, Michaelis-Menten kinetics (<i>Vm</i>)	milligram/second
Clearance (<i>Cl</i>)	liter/second
Absorption duration (<i>Tk0</i>)	second
Absorption rate (<i>ka</i>)	1/second

Use the configuration settings options to turn unit conversion on or off. For details, see “Model Simulation” on page 4-3.

For details on dimensional analysis for reaction rates, see “How Reaction Rates Are Evaluated” on page 2-11.

Create a Pharmacokinetic Model Using the Command Line

To create a PK model with the specified number of compartments, dosing type, and method of elimination:

- 1 Create a `PKModelDesign` object. The `PKModelDesign` object lets you specify the number of compartments, route of administration, and method of elimination, which SimBiology uses to construct the model object with the necessary compartments, species, reactions, and rules.

```
pkm = PKModelDesign;
```

- 2 Add a compartment specifying the compartment name, and optionally, the type of dosing, and the method of elimination. Also specify whether the data contains a response variable measured in this compartment and whether the dose(s) have time lags. For example, specify a compartment named `Central`, with `Bolus` for the `DosingType` property, `linear-clearance` for the `EliminationType` property, and `true` for the `HasResponseVariable` property.

```
pkc1 = addCompartment(pkm, 'Central', 'DosingType', 'Bolus', ...  
                    'EliminationType', 'linear-clearance', ...  
                    'HasResponseVariable', true);
```

For a description of other `DosingType` and `EliminationType` property values, see “Dosing Types” on page 5-15 and “Elimination Types” on page 5-17.

For a description of the `HasResponseVariable` property, see `HasResponseVariable`. At least one compartment in a model must have a response. Although SimBiology supports multiple responses per compartment, when adding compartments to a `PKModelDesign` object, you are limited to one response per compartment.

Note To add a compartment that has a time lag associated with any dose that targets it, set the `HasLag` property to `true`:

```
pkc_lag = addCompartment(pkm, 'Central', 'DosingType', 'Bolus', ...  
                       'EliminationType', 'linear-clearance', ...  
                       'HasResponseVariable', true, 'HasLag', true);
```

Or after adding a compartment, set its `HasLag` property to `true`:

```
pkc1.HasLag = true;
```

- 3 Optionally, add a second compartment named `Peripheral`, with no dosing, no elimination, and no time lag. Set the `HasResponseVariable` property to `true`. If you are using the tobramycin data set [1] on page 5-3, skip this step and use only one compartment.

```
pkc2 = addCompartment(pkm, 'Peripheral', 'HasResponseVariable', true);
```

The model construction process adds the necessary parameters, including a parameter representing intercompartmental clearance Q . You can add more compartments by repeating this step. The addition of each compartment creates a chain of compartments in the order of compartment addition, with a bidirectional flow of the drug between compartments in the model.

Use the handle to the compartment (`pkc1` or `pkc2`), to change compartment properties.

- 4 Construct a SimBiology model object.

```
[modelObj, PKModelMapObj] = pkm.construct
```

The `construct` method returns a SimBiology model object (`modelObj`) and a `PKModelMap` object (`PKModelMapObj`) that contains the mapping of the model components to the elements of the regression function.

Note If you change the `PKModelDesign` object, you must create a new model object using the `construct` method. Changes to the `PKModelDesign` do not automatically propagate to a previously constructed model object.

- 5 Perform parameter fitting using “Nonlinear Regression” or “Nonlinear Mixed-Effects Modeling”.

The model object and the `PKModelMap` object are input arguments for the `sbionlmeffit`, `sbionlmefitsa` and `sbionlinfit` functions used in parameter fitting.

See Also

Related Examples

- “Calculate NCA Parameters and Fit Model to PK/PD Data Using SimBiology Model Analyzer App” on page 1-77
- “Fit One-Compartment Model to Individual PK Profile” on page 4-52
- “Fit a Two-Compartment Model to PK Profiles of Multiple Individuals” on page 4-71
- “Estimate Category-Specific PK Parameters for Multiple Individuals” on page 4-58
- “Estimating the Bioavailability of a Drug” on page 4-78
- “Modeling the Population Pharmacokinetics of Phenobarbital in Neonates” on page 4-153

Creating Reaction Rates

Define Reaction Rates with Mass Action Kinetics

Use mass action kinetics to define zero-order, first-order, second-order, and reversible reactions.

Definition of Mass Action Kinetics

Mass action describes the behavior of reactants and products in an elementary chemical reaction. Mass action kinetics describes this behavior as an equation where the velocity or rate of a chemical reaction is directly proportional to the concentration of the reactants.

Zero-Order Reactions

With a zero-order reaction, the reaction rate does not depend on the concentration of reactants. Examples of zero-order reactions are synthesis from a null species, and modeling a source species that is added to the system at a specified rate.

```
reaction: null -> P
reaction rate: k mole/second
species: P = 0 mole
parameters: k = 1 mole/second
```

Note When specifying a null species, the reaction rate must be defined in units of amount per unit time not concentration per unit time.

Entering the reaction above into the software and simulating produces the following result:

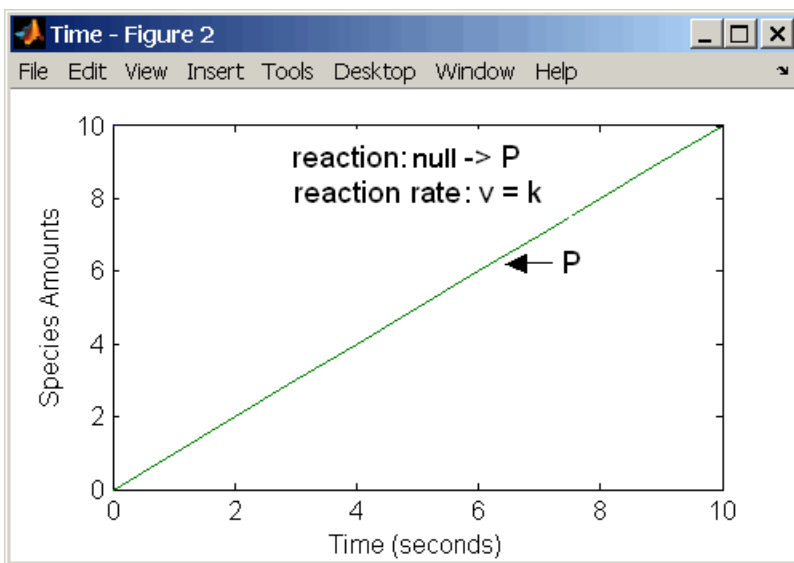

Zero-Order Mass Action Kinetics

Note If the amount of a reactant with zero-order kinetics reaches zero before the end of a simulation, then the amount of reactant can go below zero regardless of the solver or tolerances you set.

First-Order Reactions

With a first-order reaction, the reaction rate is proportional to the concentration of a single reactant. An example of a first-order reaction is radioactive decay.

```

reaction: R -> P
reaction rate: k*R mole/(liter*second)
species: R = 10 mole/liter
         P = 0 mole/liter
parameters: k = 1 1/second

```

Entering the reaction above into the software and simulating produces the following results:

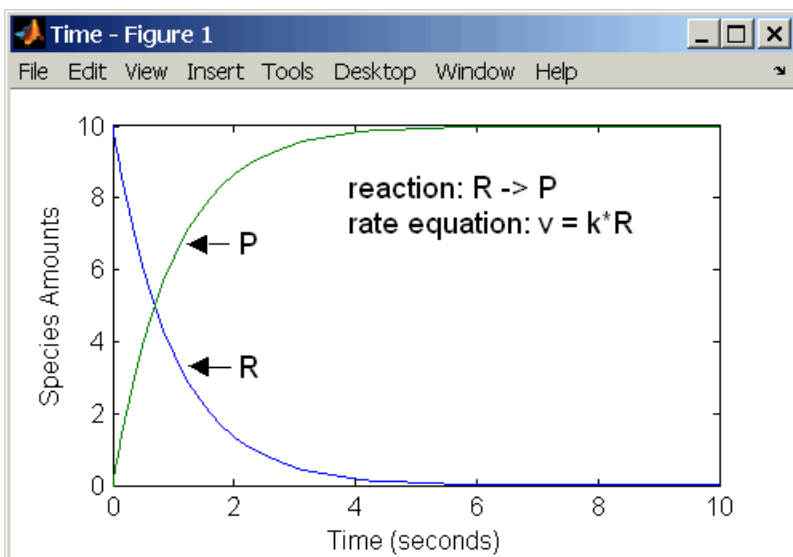

First-Order Mass Action Kinetics

Second-Order Reactions

A second-order reaction has a reaction rate that is proportional to the square or the concentration of a single reactant or proportional to two reactants. Notice the space between the reactant coefficient and the name of the reactant. Without the space, 2R would be considered the name of a species.

```

reaction: 2 R -> P
reaction rate: k*R^2 mole/(liter*second)
species: R = 10 mole/liter
         P = 0 mole/liter
parameters: k = 1 liter/(mole*second)

```

Entering the reaction above into the software and simulating produces the following results:

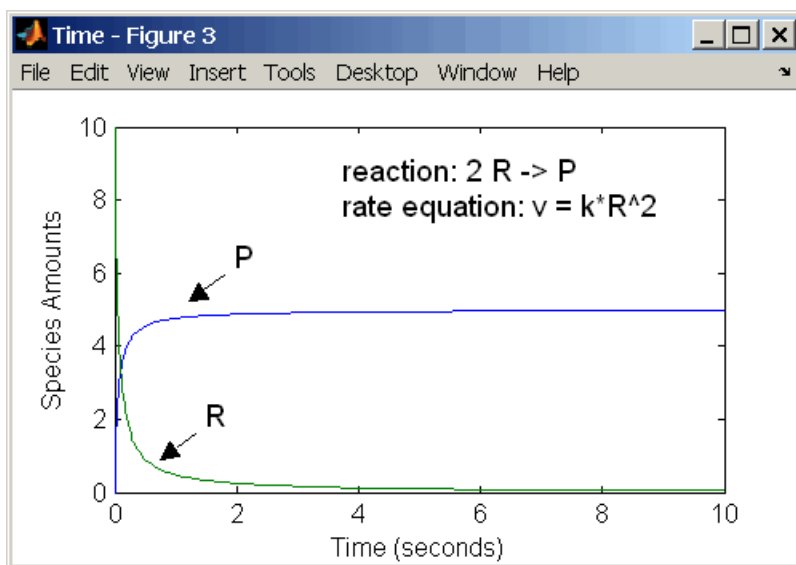

Second-Order Kinetics with Single Reactant

With two reactants, the reaction rate depends on the concentration of two of the reactants.

```

reaction: R1 + R2 -> P
reaction rate: k*R1*R2 mole/(liter*second)
species: R1 = 10 mole/liter
         R2 = 8 mole/liter
         P = 0 mole/liter
parameters: k = 1 liter/(mole*second)
    
```

Enter the reaction above into the software and simulating produces the following results. There is a difference in the final values because the initial amount of one of the reactants is lower than the other. After the first reactant is used up, the reaction stops.

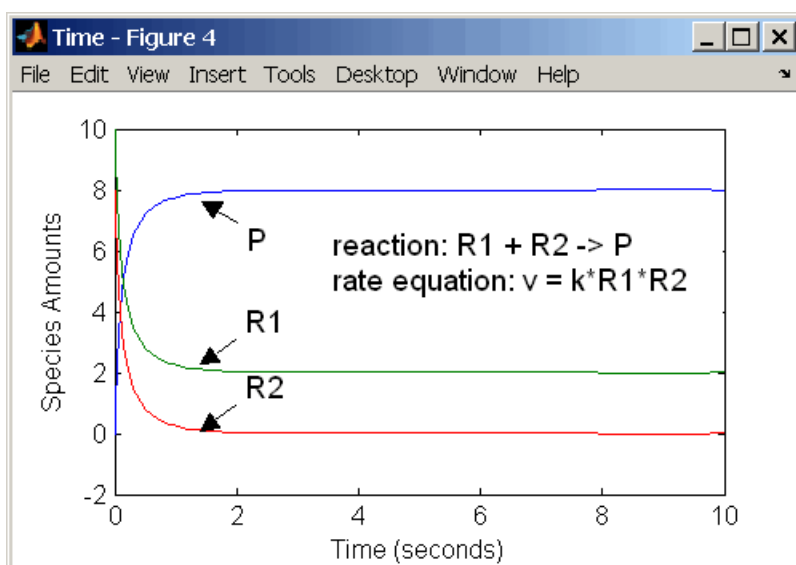

Second-Order Kinetics with Two Reactants

Reversible Mass Action

You can model reversible reactions with two separate reactions or with one reaction. With a single reversible reaction, the reaction rates for the forward and reverse reactions are combined into one expression. Notice the angle brackets before and after the hyphen to represent a reversible reaction.

```
reaction: R <-> P
reaction rate: kf*R - kr*P mole/(liter*second)
species: R = 10 mole/liter
         P = 0 mole/liter
parameters: kf = 1 1/second
            kr = 0.2 1/second
```

Entering the reaction above into the software and simulating produces the following results. At equilibrium when the rate of the forward reaction equals the reverse reaction, $v = kf*R - kr*P = 0$ and $P/R = kf/kr$.

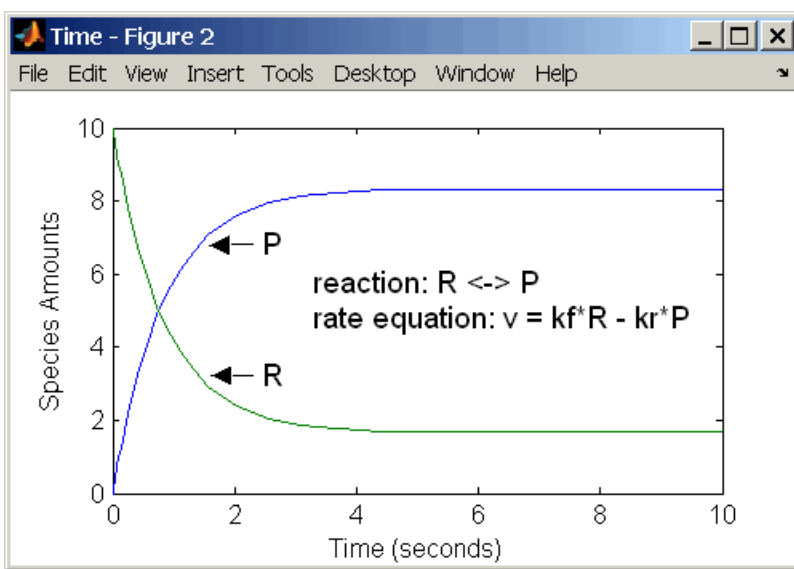

Define Reaction Rates with Enzyme Kinetics

Use differential equations, mass action kinetics, or Michaelis-Menten kinetics to define enzyme reactions.

Simple Model for Single Substrate Catalyzed Reactions

A simple model for enzyme-catalyzed reactions starts a substrate S reversibly binding with an enzyme E. Some of the substrate in the substrate/enzyme complex is converted to product P with the release of the enzyme.

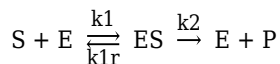

$$v_1 = k_1[S][E], \quad v_{1r} = k_{1r}[ES], \quad v_2 = k_2[ES]$$

This simple model can be defined with

- Differential rate equations. See “Enzyme Reactions with Differential Rate Equations” on page A-6.
- Reactions with mass action kinetics. See “Enzyme Reactions with Mass Action Kinetics” on page A-7.
- Reactions with Henri-Michaelis-Menten kinetics. See “Enzyme Reactions with Irreversible Henri-Michaelis-Menten Kinetics” on page A-8.

Enzyme Reactions with Differential Rate Equations

The reactions for a single-substrate enzyme reaction mechanism (see “Simple Model for Single Substrate Catalyzed Reactions” on page A-6) can be described with differential rate equations. You can enter the differential rate equations into the software as rate rules.

```

reactions: none
reaction rate: none
rate rules: dS/dt = k1r*ES - k1*S*E
            dE/dt = k1r*ES + k2*ES - k1*S*E
            dES/dt = k1*S*E - k1r*ES - k2*ES
            dP/dt = k2*ES
species: S = 8 mole
         E = 4 mole
         ES = 0 mole
         P = 0 mole
parameters: k1 = 2 1/(mole*second)
            k1r = 1 1/second
            k2 = 1.5 1/second
    
```

Remember that the rate rule $dS/dt = f(x)$ is written in a SimBiology rate rule expression as $S = f(x)$. For more information about rate rules see “Rate Rules” on page 2-14.

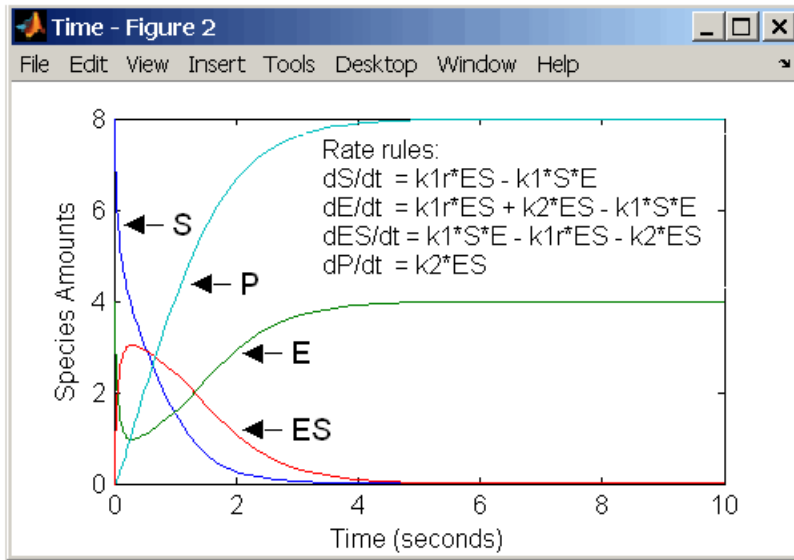

Alternatively, you could remove the rate rule for ES, add a new species `Ettotal` for the total amount of enzyme, and add an algebraic rule $0 = Ettotal - E - ES$, where the initial amounts for `Ettotal` and `E` are equal.

```

reactions: none
reaction rate: none
rate rules: dS/dt = k1r*ES - k1*S*E
            dE/dt = k1r*ES + k2*ES - k1*S*E
            dP/dt = k2*ES
algebraic rule: 0 = Ettotal - E - ES
species: S = 8 mole
          E = 4 mole
          ES = 0 mole
          P = 0 mole
          Ettotal = 4 mole
parameters: k1 = 2 1/(mole*second)
            k1r = 1 1/second
            k2 = 1.5 1/second

```

Enzyme Reactions with Mass Action Kinetics

Determining the differential rate equations for the reactions in a model is a time-consuming process. A better way is to enter the reactions for a single substrate enzyme reaction mechanism directly into the software. The following example uses models an enzyme catalyzed reaction with mass action kinetics. For a description of the reaction model, see "Simple Model for Single Substrate Catalyzed Reactions" on page A-6.

```

reaction: S + E -> ES
reaction rate: k1*S*E (binding)

reaction: ES -> S + E
reaction rate: k1r*ES (unbinding)

reaction: ES -> E + P
reaction rate: k2*ES (transformation)

```

```

species: S = 8   mole
        E = 4   mole
        ES = 0  mole
        P = 0   mole
parameters: k1 = 2  1/(mole*second)
           k1r = 1  1/second
           k2 = 1.5 1/second
    
```

The results for a simulation using reactions are identical to the results from using differential rate equations.

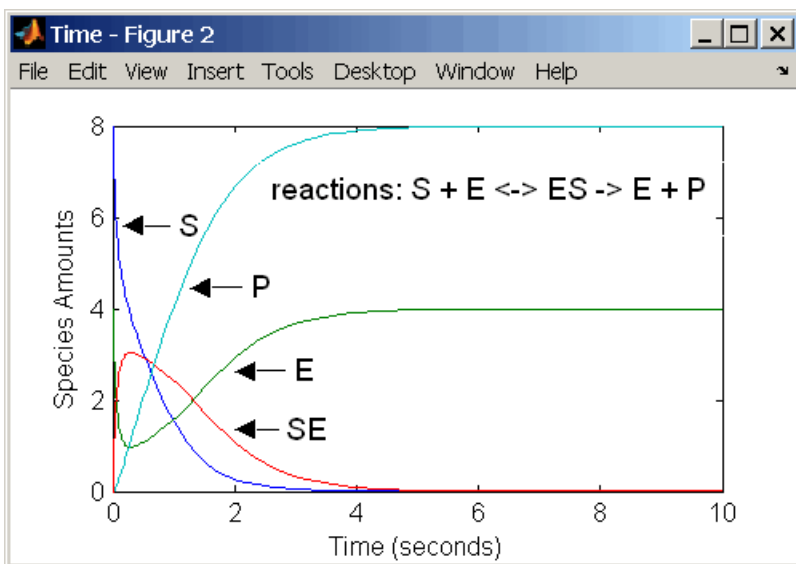

Enzyme Reactions with Irreversible Henri-Michaelis-Menten Kinetics

Representing an enzyme-catalyzed reaction with mass action kinetics requires you to know the rate constants k_1 , k_{1r} , and k_2 . However, these rate constants are rarely reported in the literature. It is more common to give the rate constants for Henri-Michaelis-Menten kinetics with the maximum velocity $V_m = k_2 \cdot E$ and the constant $K_m = (k_{1r} + k_2) / k_1$. The reaction rate for a single substrate enzyme reaction using Henri-Michaelis-Menten kinetics is given below. For information about the model, see “Simple Model for Single Substrate Catalyzed Reactions” on page A-6.

$$v = \frac{V_{max}[S]}{K_m + [S]}$$

The following example models an enzyme catalyzed reaction using Henri-Michaelis-Menten kinetics with a single reaction and reaction rate equation. Enter the reaction defined below into the software and simulate.

```

reaction: S -> P
reaction rate: Vmax*S/(Km + S)
species:   S = 8   mole
          P = 0   mole
parameters: Vmax = 6   mole/second
           Km = 1.25 mole
    
```

The results show a plot slightly different from the plot using mass action kinetics. The differences are due to assumptions made when deriving the Michaelis-Menten rate equation.

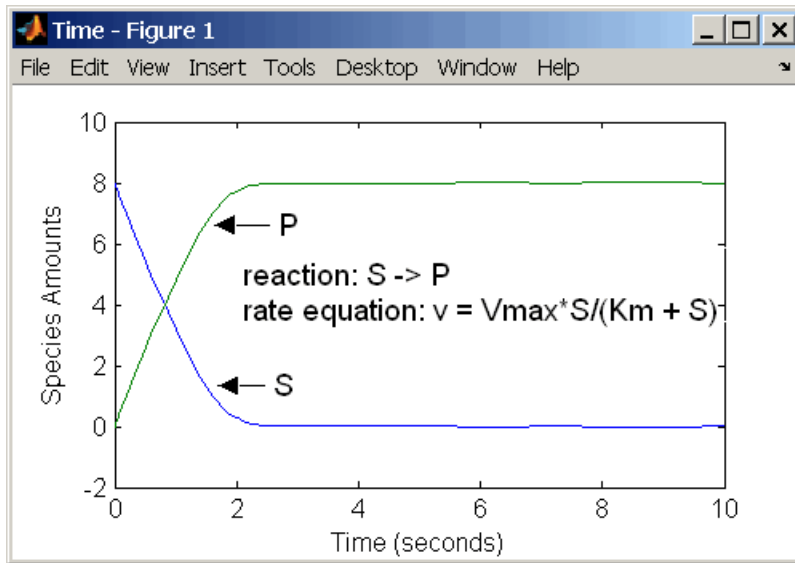

Models Used in Examples

Minimal Cascade Model for a Mitotic Oscillator

Albert Goldbeter modified a model with enzyme cascades [Goldbeter and Koshland 1981 on page B-13] to fit cell cycle data from studies with embryonic cells [Goldbeter 1991 on page B-13]. He used this model to demonstrate thresholds with enzyme cascades and periodic behavior caused by negative feedback.

There are two SimBiology model variations using Goldbeter's model. The first model uses the differential rate equations directly from Goldbeter's paper. The second model is built with reactions using Henri-Michaelis-Menten kinetics.

In this section...
“Goldbeter Model” on page B-2
“SimBiology Model with Rate Rules” on page B-4
“SimBiology Model with Reactions” on page B-5
“References” on page B-13

Goldbeter Model

- “About the Goldbeter Model” on page B-2
- “Reaction Descriptions and Model Assumptions” on page B-3
- “Mathematical Model” on page B-3

About the Goldbeter Model

Albert Goldbeter created a simple cell division model from studies with embryonic cells [Goldbeter 1991 on page B-13]. This model demonstrates thresholds with enzyme cascades and periodic behavior caused by negative feedback.

There are six species in Goldbeter's minimal mitotic oscillator model [Goldbeter 1991 on page B-13].

- C — Cyclin. The periodic behavior of cyclin activates and deactivates an enzyme cascade.
- M⁺, M — Inactive (phosphorylated) and active forms of cdc2 kinase. Kinases catalyze the addition of phosphate groups onto amino acid residues.
- X⁺, X — Inactive and active (phosphorylated) forms of a cyclin protease. Proteases degrade proteins by breaking peptide bonds.

The reactions are labeled r1 to r7 on the following diagram.

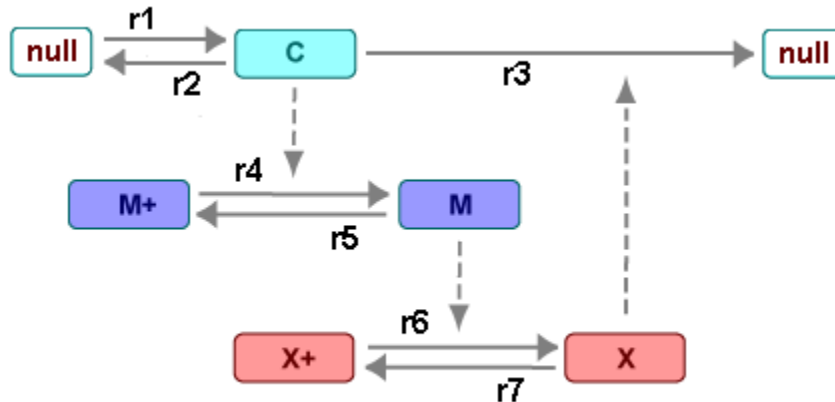

This model shows:

- How thresholds with cdc2 kinase activation ($M^+ \rightarrow M$) and protease activation ($X^+ \rightarrow X$) can occur as the result of covalent modification (for example, phosphorylation or dephosphorylation), but without the need for positive feedback.
- How periodic behavior with cdc2 kinase activation can occur with negative feedback and the time delay associated with activation/deactivation enzyme cascades.

Reaction Descriptions and Model Assumptions

The following list describes each of the reactions in Goldbeter's minimal mitotic oscillator with some of the simplifying assumptions. For a more detailed explanation of the model, see [Goldbeter 1991 on page B-13].

- Cyclin (C) is synthesized at a constant rate (r_1) and degraded at a constant rate (r_2).
- Cyclin (C) does not complex with cdc2 kinase (M).
- Cyclin (C) activates cdc2 kinase ($M^+ \rightarrow M$) by increasing the velocity of the phosphatase that activates the kinase. Inactive cdc2 kinase (M^+) is activated by removing inhibiting phosphate groups (r_4).
- The amount of deactivating kinase (not modeled) for the cdc2 kinase (M) is constant. Active cdc2 kinase (M) is deactivated by adding inhibiting phosphate group (r_5).
- The activation of cyclin protease ($X^+ \rightarrow X$) by the active cdc2 kinase (M) is direct without other intervening cascades. Cyclin protease (X) is activated by adding phosphate groups (r_6).
- The amount of deactivating phosphatase (not modeled) for the cyclin protease (X) is constant. Active cyclin protease (X) is deactivated by removing the activating phosphate groups (r_7).
- The three species of interest are cyclin (C), active dephosphorylated cdc2 kinase (M), and active phosphorylated protease (X). The total amounts of ($M + M^+$) and ($X + X^+$) are constant.

Mathematical Model

Goldbeter's minimal mitotic oscillator model is defined with three differential rate equations and two algebraic equations that define changing parameters in the rate equations.

Differential Rate Equation 1, Cyclin (C)

The following differential rate equation is from [Goldbeter 1991 on page B-13] for cyclin (C).

$$\frac{dC}{dt} = v_i - v_d X \frac{C}{K_d + C} - k_d C$$

Differential Rate Equation 2, Kinase (M)

The following differential rate equation is for cdc2 kinase (M). Notice that (1 - M) is the amount of inactive (phosphorylated) cdc2 kinase (M+).

$$\frac{dM}{dt} = V_1 \frac{(1 - M)}{K_1 + (1 - M)} - V_2 \frac{M}{K_2 + M}$$

$$V_1 = \frac{VM_1[C]}{K_c + [C]}$$

Differential Rate Equation 3, Protease (X)

Differential rate equations for cyclin protease (X). Notice that (1 - X) is the amount of inactive (unphosphorylated) cyclin protease (X+).

$$\frac{dX}{dt} = V_3 \frac{(1 - X)}{K_3 + (1 - X)} - V_4 \frac{X}{K_4 + X}$$

$$V_3 = VM_3[M]$$

SimBiology Model with Rate Rules

- “SimBiology Model with Rules” on page B-4
- “SimBiology Simulation with Rules” on page B-5

SimBiology Model with Rules

In the literature, many biological models are defined using differential rate and algebraic equations. With SimBiology software, you can enter the equations directly as SBML rules. The example in this section uses Goldbeter's mitotic oscillator to illustrate this point.

Writing differential rate equations in an unambiguous format that a software program can understand is a fairly simple process.

- Use an asterisk to indicate multiplication. For example, $k[a]$ is written $k*a$.
- Remove square brackets that indicate concentration from around species. The units associated with the species will indicate concentration (moles/liter) or amount (moles, molecules).

SimBiology software uses square brackets around species and parameter name to allow names that are not valid MATLAB variable names. For example, you could have a species named `glucose-6-phosphate dehydrogenase` but you need to add brackets around the name in reaction rate and rule equations.

- Use parentheses to clarify the order of evaluation for mathematical operations. For example, do not write a Henri-Michaelis-Menten rate as $V_m*C/K_d + C$, because V_m*C is divided by K_d before adding C , and then C is added to the result.

The following equation is the rate rule for “Differential Rate Equation 1, Cyclin (C)” on page B-3:

$$dC/dt = v_i - (v_d*X*C)/(K_d + C) - k_d*C$$

The following equations are the rate and `repeatedAssignment` rules for “Differential Rate Equation 2, Kinase (M)” on page B-4:

$$\begin{aligned}dM/dt &= (V1*Mplus)/(K1 + Mplus) - (V2*M)/(K2 + M) \\V1 &= (VM1*C)/(Kc + C) \\Mplus &= Mt - M\end{aligned}$$

The following equations are the rate and `repeatedAssignment` rules for “Differential Rate Equation 3, Protease (X)” on page B-4:

$$\begin{aligned}dX/dt &= (V3*Xplus)/(K3 + Xplus) - (V4*X)/(K4 + X) \\V3 &= VM3*M \\Xplus &= Xt - X\end{aligned}$$

Rules

The active (M) and inactive (Mplus) forms of the kinase are assumed to be part of a conserved cycle with the total concentration (Mt) remaining constant during the simulation. You need only one differential rate equation with a mass balance equation to define the amounts of both species. Similarly, the active (X) and inactive (Xplus) forms of the protease are part of a second conserved cycle.

SimBiology Simulation with Rules

This is a simulation of Goldbeter's minimal mitotic oscillator using differential rate and algebraic equations. Simulate with the `sundials` solver and plot species C, M, and X. For a description of the model, see “SimBiology Model with Rules” on page B-4.

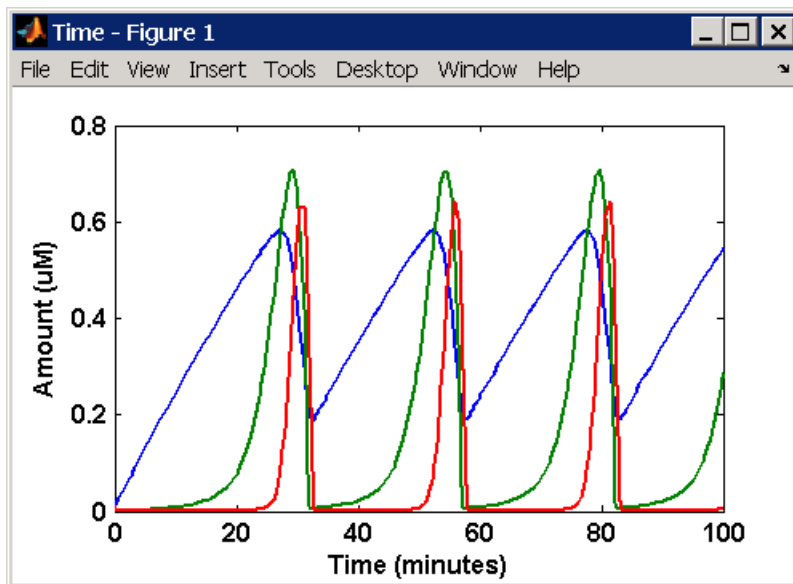

SimBiology Model with Reactions

- “Converting Differential Rate Equations to Reactions” on page B-6
- “Calculating Initial Values for Reactions” on page B-7
- “SimBiology Simulation with Reactions” on page B-12

Converting Differential Rate Equations to Reactions

In the literature, many models are defined with differential rate equations. With SimBiology software, creating the differential equations from reactions is unnecessary; you can enter the reactions and let the software calculate the equations.

Some models are defined with differential rate equations, and you might need the reactions to be compatible with your model. Two rules you can use to convert differential rate equations to reactions are:

- **For a positive term** — The species described by the equation is placed on the right as a product, and the species in the term are placed on the left as reactants.
- **For a negative term** — The species described by the equation is placed on the left as a product, and the species in the term are also placed on the left as reactants.

You need to determine the products using additional information, for example, a reaction diagram, a description of the model, or an understanding of a reaction. If a reaction is catalyzed by a kinase, then you can conclude that the product has one or more additional phosphate groups.

A simple first-order reaction has differential rate equation $dR/dt = +kr[P] - kf[R]$. The negative term implies that the reaction is $R \rightarrow ?$ with an unknown product. The positive term identifies the product and completes the reaction, $R \leftrightarrow P$.

Reactions R1 to R3 from Equation E1

The differential rate equation 1 is repeated here for comparison with the reactions. See “Differential Rate Equation 1, Cyclin (C)” on page B-3.

$$\frac{dC}{dt} = v_i - v_d X \frac{C}{K_d + C} - k_d C$$

The reaction and reaction rate equations from the differential rate equation E1 are given below:

```
r1      reaction: null -> C
        reaction rate: v_i

r2      reaction: C -> null
        reaction rate: k_d*C

r3      reaction: C -> null
        reaction rate: (v_d*X*C)/(K_d + C)
```

Reactions R4 and R5 from Equation E2

The differential rate equation 2 and algebraic equation 2 are repeated here for comparison with the reactions. See “Differential Rate Equation 2, Kinase (M)” on page B-4.

$$\frac{dM}{dt} = V_1 \frac{(1 - M)}{K_1 + (1 - M)} - V_2 \frac{M}{K_2 + M}$$

$$V_1 = \frac{VM_1[C]}{K_c + [C]}$$

The reaction and reaction rate equations from the differential rate equation E2 are given below:

```
r4      reaction: Mplus -> M
        reaction rate: V1*Mplus/(K1 + Mplus)
```

repeatedAssignment rule: $V1 = VM1 * C / (Kc + C)$

r5 reaction: $M \rightarrow Mplus$
 reaction rate: $V2 * M / (K2 + M)$

Reactions R6 and R7 from Equation E3

The differential rate equation for equation 3 and algebraic equation 3 is repeated here for comparison with the reactions.

$$\frac{dX}{dt} = V3 \frac{(1 - X)}{K3 + (1 - X)} - V4 \frac{X}{K4 + X}$$

$V3 = VM3 * [M]$

The reaction and reaction rate equations from the differential rate equation E3 are given below:

r6 reaction: $Xplus \rightarrow X$
 reaction rate: $V3 * Xplus / (K3 + Xplus)$
 repeatedAssignment rule: $V3 = VM3 * M$

r7 reaction: $X \rightarrow Xplus$
 reaction rate: $V4 * X / (K4 + X)$

Calculating Initial Values for Reactions

After you converted the differential rate equations to the reactions and reaction rate equations, you can start to fill in initial values for the species (reactants and products) and parameters.

The initial values for parameters and amounts for species are listed with four different units in the same dimension:

- A — Original units in the Goldbeter 1991 paper.
- B — Units of concentration with time converted to second. When converting a to b, use 1 minute = 60 second for parameters.

$$\frac{X \text{ uM}}{\text{minute}} \times \frac{1e-6 \text{ mole/liter}}{1 \text{ uM}} \times \frac{1 \text{ minute}}{60 \text{ second}} = \frac{Y \text{ mole}}{\text{liter*second}}$$

- C — Units of amount as moles. When converting concentration to moles, use a cell volume of $1e-12$ liter and assume that volume does not change.

$$\frac{Y \text{ mole}}{\text{liter*second}} \times \frac{1e-12 \text{ liter}}{1 \text{ mole}} = \frac{Z \text{ mole}}{\text{second}}$$

- D — Units of amount as molecules. When converting amount as moles to molecules, use $6.022e23$ molecules = 1 mole.

$$\frac{Z \text{ mole}}{\text{second}} \times \frac{6.022e23 \text{ molecule}}{1 \text{ mole}} = \frac{N \text{ molecules}}{\text{second}}$$

With dimensional analysis on and unit conversion off, select all of the units for one letter. For example, select all of the As. If dimensional analysis and unit conversion are on, you can mix and match letters and get the same answer.

Reaction 1 Cyclin Synthesis

R1		Value	Units
reaction	null -> C	----	----
reaction rate	v_i	----	A. uM/minute B. mole/(liter*second) C. mole/second D. molecule/second
parameters	v_i	0.025 4.167e-10 4.167e-22 205	A. uM/minute B. mole/(liter*second) C. mole/second D. molecule/second
species	C	0.01 1e-8 1.0e-20 6.022e+3	A. uM B. mole/liter C. mole D. molecule

Reaction 2 Cyclin Undifferentiated Degradation

R2		Value	Units
reaction	C -> null	----	----
reaction rate	$k_d * C$	----	A. uM/minute B. mole/(liter*second) C. mole/second D. molecule/second
parameters	k_d	0.010 1.6667e-4	A. 1/minute B, C, D. 1/second
species	C	0.01 1e-8 1.0e-20 6.022e+3	A. uM B. mole/liter C. mole D. molecule

Reaction 3 Cyclin Protease Degradation

R3		Value	Units
reaction	C -> null	----	----
reaction rate	$(v_d * X * C) / (K_d + C)$	----	A. uM/minute B. mole/(liter*second) C. mole/second D. molecule/second
parameter	v_d	0.25 0.0042	A. 1/minute B, C, D. 1/second

R3		Value	Units
parameter	Kd	0.02	A. uM
		2.0e-8	B. mole/liter
		2.0e-020	C. mole
		12044	D. molecule
species	C (substrate)	0.01	A. uM
		1e-8	B. mole/liter
		1.0e-20	C. mole
		6.022e+3	D. molecule
species	X (enzyme)	0.01	A. uM
		1e-8	B. mole/liter
		1.0e-20	C. mole
		6.022e+3	D. molecule

Reaction 4 Cdc2 Kinase Activation

R4		Value	Units
reaction	Mplus -> M	----	----
reaction rate	$(V1 * Mplus) / (K1 + Mplus)$	----	A. uM/minute
		----	B. mole/(liter*second)
		----	C. mole/second
		----	D. molecule/second
repeatedAssignment rule	$V1 = (VM1 * C) / (Kc + C)$	----	
parameter	V1 (variable by rule)	0.00	A. uM/minute
			B. mole/(liter*second)
			C. mole/second
			D. molecule/second
parameter	VM1	3.0	A. uM/minute
		5.0e-8	B. mole/(liter*second)
		5.0000e-020	C. mole/second
		30110	D. molecule/second
parameter	Kc	0.5	A. uM
		5.0000e-7	B. mole/liter
		5.0e-19	C. mole
		3.011e+5	D. molecule
parameter	K1	0.005	A. uM
		5e-9	B. mole/liter

R4		Value	Units
species	M _{plus} (inactive substrate)	5e-21	C. mole
		3.011e+3	D. molecule
		0.99	A. uM
		9.9e-7	B. mole/liter
species	M (active product)	9.9e-19	C. mole
		5.962e+5	D. molecule
		0.01	A. uM
		1e-8	B. mole/liter
species	C	1.0e-20	C. mole
		6.022e+3	D. molecule
		0.01	A. uM
		1e-8	B. mole/liter
		1.0e-20	C. mole
		6.022e+3	D. molecule

Reaction 5 Cdc2 Kinase Deactivation

R5		Value	Units
reaction	M -> M _{plus}	---	---
reaction rate	$(V2 * M) / (K2 + M)$	---	A. uM/minute
		---	B. (mole/liter-second)
		---	C. mole/second
		---	D. molecule/second
parameter	V2	1.5	A. uM/minute
		2.5000e-008	B. mole/liter-second
		2.5000e-020	C. mole/second
		15055	D. molecule/second
parameter	K2	0.005	A. uM
		5.0000e-009	B. mole/liter
		5.0000e-021	C. mole
		3011	D. molecule
species	M _{plus} (inactive)	1.0e-20	C. mole
		0.99	A. uM
		9.9e-7	B. mole/liter
		9.9e-19	C. mole
species	M (active)	5.962e+5	D. molecule
		0.01	A. uM
		1e-8	B. mole/liter

R5		Value	Units
		1.0e-20	C. mole
		6.022e+3	D. molecule

Reaction 6 Protease Activation

R6		Value	Units
reaction	$X_{plus} \rightarrow X$	---	---
reaction rate	$(V3 * X_{plus}) / (K3 + X_{plus})$	---	A. uM/minute B. mole/(liter*second) C. mole/second D. molecule/second
repeatedAssignment rule	$V3 = VM3 * M$	---	
parameter	V3 (variable by rule)		A. uM/minute B. mole/liter-second C. mole/second D. molecule/second
parameter	VM3	1.0 0.0167	A. 1/minute B, C, D. 1/second
parameter	K3	0.005 5e-9 5e-21 3.011e+3	A. uM B. mole/liter C. mole D. molecule
species	X_{plus} (inactive substrate)	0.99 9.9e-7 9.9e-19 5.962e+5	A. uM B. mole/liter C. mole D. molecule
species	X (active product)	0.01 1e-8 1.0e-20 6.022e+3	A. uM B. mole/liter C. mole D. molecule
species	M (enzyme)	0.01 1e-8 1.0e-20 6.022e+3	A. uM B. mole/liter C. mole D. molecule

Reaction 7 Protease Deactivation

R7		Value	Units
reaction	$X \rightarrow X_{plus}$	---	---
reaction rate	$(V4 * X) / (K4 + X)$	---	A. uM/minute
		---	B. mole/(liter*second)
		---	C. mole/second
		---	D. molecule/second
parameter	V4	0.5	A. uM/minute
		8.3333e-009	B. mole/(liter*second)
		8.3333e-021	C. mole/second
		5.0183e+003	D. molecule/second
parameter	K4	0.005	A. uM
		5e-9	B. mole/liter
		5e-21	C. mole
		3011	D. molecule
species	Xplus (inactive)	0.99	A. uM
		9.9e-7	B. mole/liter
		9.9e-19	C. mole
		5.962e+5	D. molecule
species	X (active)	0.01	A. uM
		1e-8	B. mole/liter
		1.0e-20	C. mole
		6.022e+3	D. molecule

SimBiology Simulation with Reactions

This is a simulation of Goldbeter's minimal mitotic oscillator with rate and algebraic equations. Simulate with the sundials solver and plot species C, M, and X. For a description of the model, see "SimBiology Model with Reactions" on page B-5.

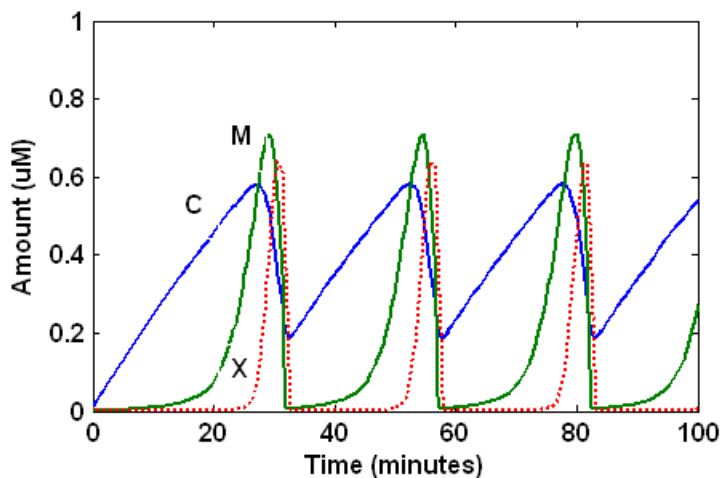

References

- [1] Goldbeter A. (1991), "A minimal cascade model for the mitotic oscillator involving cyclin and cdc2 kinase," *Proceedings of the National Academy of Sciences USA*, 88:9107-9111.
- [2] Goldbeter A., Koshland D. (1981), "An amplified sensitivity arising from covalent modification in biological systems," *Proceedings of the National Academy of Sciences USA*, 78:6840-6844.
- [3] Goldbeter A., Koshland D. (1984), "Ultrasensitivity in biochemical systems controlled by covalent modification," *The Journal of Biological Chemistry*, 259:14441-14447.
- [4] Goldbeter A., home page on the Web, <http://www.ulb.ac.be/sciences/utc/GOLDBETER/agoldbet.html>.
- [5] Murray A.W., Kirschner M.W. (1989), "Cyclin synthesis drives the early embryonic cell cycle," *Nature*, 339:275-280.

Model of the Yeast Heterotrimeric G Protein Cycle

In this section...

“Background on G Protein Cycles” on page B-14

“Modeling a G Protein Cycle” on page B-15

“References” on page B-17

Background on G Protein Cycles

- “G Proteins” on page B-14
- “G Proteins and Pheromone Response” on page B-14

G Proteins

Cells rely on signal transduction systems to communicate with each other and to regulate cellular processes. G proteins are GTP-binding proteins that are involved in the regulation of many cellular processes. There are two known classes of G proteins: the monomeric G proteins (one GTPase), and the heterotrimeric G proteins (three different monomers). The G proteins usually facilitate a step requiring energy. This energy is supplied by the hydrolysis of GTP by a GTPase activating protein (GAP). The exchange of GDP for GTP is catalyzed by a guanine nucleotide releasing protein (GNRP) [Alberts et al. 1994 on page B-17].



G protein-coupled receptors (GPCRs) are the targets of many pharmaceutical agents. Some estimates suggest that 40 to 50% of currently marketed drugs target GPCRs and that 40% of current drug discovery focus is on GPCR targets. Some examples include those for reducing stomach acid (ranitidine which targets histamine H2 receptor), migraine (sumatriptan, which targets a serotonin receptor subtype), schizophrenia (olanzapine, which targets serotonin and dopamine receptors), allergies (desloratadine, which targets histamine receptors). One approach in pharmaceutical research is to model signaling pathways to analyze and predict both downstream effects and effects in related pathways. This tutorial examines model building and analysis of the G protein cycle in the yeast pheromone response pathway using the SimBiology desktop.

G Proteins and Pheromone Response

In the yeast *Saccharomyces cerevisiae*, G protein signaling in pheromone response is a well characterized signal transduction pathway. The pheromone secreted by *alpha* cells activates the G protein-coupled α -factor receptor (Ste2p) in *a* cells which results in a variety of cell responses including cell-cycle arrest and synthesis of new proteins. The authors of the study performed a quantitative analysis of this cycle, compared the regulation of G protein activation in wild-type yeast haploid *a* cells with cells containing mutations that confer supersensitivity to α -factor. They analyzed the data in the context of cell-cycle arrest and pheromone-induced transcriptional activation and developed a mathematical model of the G protein cycle that they used to estimate rates of activation and deactivation of active G protein in the cell.

Modeling a G Protein Cycle

- “Reactions Overview” on page B-15
- “Assumptions, Experimental Data, and Units in the G Protein Model” on page B-16

Reactions Overview

Systems biologists represent biological pathways and processes as reactions with reaction rates, and treat the components of these pathways as individual species.

The G protein cycle in the yeast pheromone-response pathway can be condensed into a set of biochemical reactions. These reactions are complex formation, transformation, or disassociation reactions that Yi and colleagues [Yi et al. 2003 on page B-17] use to simplify and describe the system. In this example, α -factor, α -factor receptor, and the G protein subunits are all treated as species participating in reactions. The system can be graphically represented as follows.

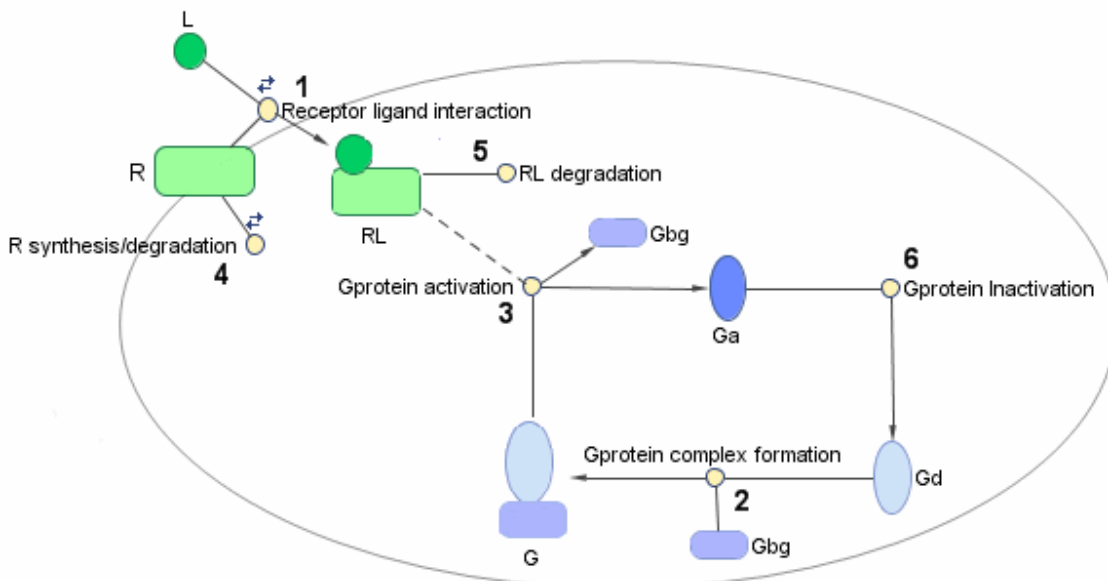

Graphical Representation of the G protein cycle in yeast pheromone response. The numbers represent reaction numbers referenced in the text. L = Ligand (alpha factor), R = alpha-factor receptor, Gbg = free levels of G-beta:G-gamma complex, Ga = active G-alpha-GTP, Gd = inactive G-alpha-GDP, G = inactive Gbg:Gd complex.

The following table shows you the reactions used to model the G protein cycle and the corresponding rate constants (rate parameters) for each reaction. For reversible reactions, the forward rate parameter is listed first.

No.	Name	Reaction	Rate Parameters
1	Receptor-ligand interaction	$L + R \rightleftharpoons RL$	k_{RL}, k_{RLm}
2	Heterotrimeric G protein formation	$Gd + Gbg \rightarrow G$	k_{G1}

No.	Name	Reaction	Rate Parameters
3	G protein activation	$RL + G \rightarrow Ga + Gbg + RL$	kGa
4	Receptor synthesis and degradation	$R \leftrightarrow null$	kRdo, kRs
5	Receptor-ligand degradation	$RL \rightarrow null$	kRD1
6	G protein inactivation	$Ga \rightarrow Gd$	kGd

Note that in reaction 3 (G protein activation), RL appears on both sides of the reaction. This is because RL is treated as a modifier or catalyst, and the model assumes that there is no synthesis or consumption of RL in this reaction.

The authors use a set of ordinary differential equations (ODEs) to describe the system. In the software, you can represent the biological pathway as a system of biochemical reactions and the software creates the ODEs for you. Alternatively, if you have a set of ODEs that describe your system you can enter these as rate rules. For an example of modeling using rate rules, see “SimBiology Model with Rate Rules” on page B-4.

Assumptions, Experimental Data, and Units in the G Protein Model

The authors have obtained experimental data either through their own measurements or through published literature. As with any other model, the G protein cycle model simplifies the biological process while also trying to reconcile the experimental data. Consider these points:

- Reaction 2 — Binding and formation of the heterotrimeric G protein complex is treated as a single-step reaction.
- Reaction 3 — Activation of G protein is modeled as a single-step. Guanine nucleotide exchange factors (GEFs) are not modeled.
- Reactions 3 and 6 — The parameters for the rate of G protein activation and deactivation (kGa and kGd) have been estimated based on the dose response curves in the reference paper. The SimBiology model being built in this tutorial directly uses those values.
- Reactions 4 and 5 — Receptor synthesis and degradation are handled purely as two simple reaction steps.
- Reaction 6 — Deactivation of G protein by the regulator of G protein signaling (RGS) protein Sst2p is modeled as a single step. Sst2p is not modeled.

The reaction is modeled with an estimated reaction rate of 0.11 s^{-1} in the Sst2p containing wild-type strain. The uncatalyzed reaction rate is estimated to be 0.004 s^{-1} in a strain with a deletion of SST2 (*sst2Δ*, mutant strain).

- Free GDP, GTP, and Pi are not included in the model.

This tutorial shows you how to plot the experimental data over the simulation plot of the active G protein fraction. You can estimate the values of the experimental data of interest for this example from the coordinates of the plots found in Figure 5 of the reference paper [Yi et al. 2003 on page B-17]. The following values were obtained by comparing the coordinates of the standards with those of the unknowns in the figure.

Time	Fraction of Active Ga (Experimental)
0	0.00

Time	Fraction of Active Ga (Experimental)
10	0.35
30	0.40
60	0.36
110	0.39
210	0.33
300	0.24
450	0.17
600	0.20

Note The SimBiology **Dimensional Analysis** feature is not used in this tutorial. For this tutorial, the values of all species are converted to have the unit `molecule`, and all rate parameters are converted to have either the unit `1/second` or the units `1/(molecule*second)`, depending on whether the reaction is first or second order. You should leave the **InitialAmountUnits** box for species and the **ValueUnits** box for rate parameters empty for the models in this tutorial.

References

- [1] Tau-Mu Yi, Hiroaki Kitano, and Melvin I. Simon. A quantitative characterization of the yeast heterotrimeric G protein cycle. PNAS (2003) vol. 100, 10764-10769.
- [2] Alberts, B., Bray, D., Lewis, J., Raff, M., Roberts, K., and Watson, J.D. Molecular Biology of the Cell, 3rd edition, Garland Publishing, 1994.

See Also

Related Examples

- “Parameter Scanning, Parameter Estimation, and Sensitivity Analysis in the Yeast Heterotrimeric G Protein Cycle” on page 4-127

Model of M-Phase Control in *Xenopus* Oocyte Extracts

John Tyson's Computational Cell Biology Lab created a mathematical model for M-phase control in *Xenopus* oocyte (frog egg) extracts [Marlovits et al. 1998 on page B-41]. The M-phase control model shows principles by which you can apply phosphorylation and regulatory loops in your own models. Publications typically list systems of ordinary differential equations (ODEs) that represent a model system. This example shows you how to interpret these ODEs in the form of reaction pathways that are easier to represent and visualize in SimBiology software.

The model is centered around M-phase promoting factor (MPF). There are two positive feedback loops where MPF increases its synthesis and a negative feedback loop where MPF decreases its amount by increasing its degradation.

In this section...

"M-Phase Control Model" on page B-18

"M-Phase Control Equations" on page B-19

"SimBiology Model with Rate and Algebraic Rules" on page B-25

"SimBiology Model with Reactions and Algebraic Rules" on page B-29

"References" on page B-41

M-Phase Control Model

- "Synthesis Reactions" on page B-18
- "Regulation Reactions with Active MPF" on page B-18

Synthesis Reactions

Cyclin B (CycB) dimerizes with Cdc2 kinase (Cdc2) to form M-phase promoting factor (MPF).

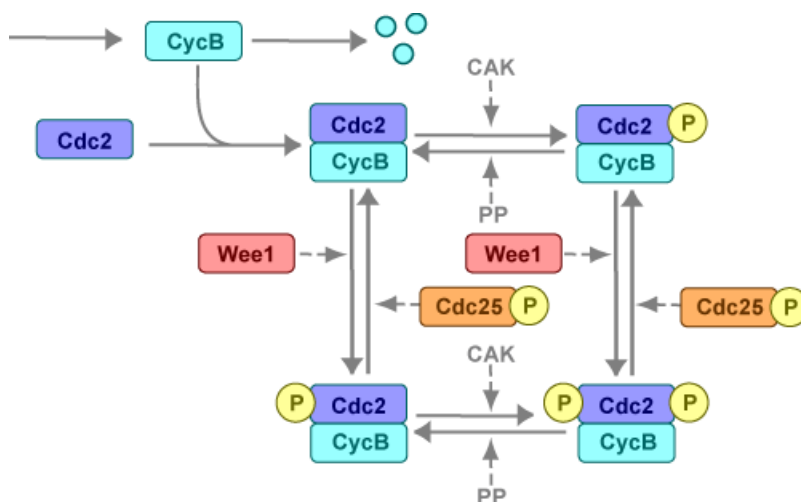

Regulation Reactions with Active MPF

Positive feedback loops with M-phase promoting factor (MPF) activate the Cdc25 phosphatase and deactivate the Wee1 kinase. A negative feedback loop with MPF activates anaphase-promoting complex (APC) that regulates the degradation of the Cyclin B subunit.

convert models published in the literature to a SimBiology format. The equation numbers match the published paper for this model [Marlovits et al. 1998 on page B-41]. Equations that are missing in the sequence involve the Cdk inhibitor (CKI) protein, which is not currently modeled in the SimBiology version.

Converting Differential Equations to Reactions

The rules for writing reaction and reaction rate equations from differential rate equations include not only the equations but also an understanding of the reactions. dx/dt refers to the species the differential rate equation is defining. *kinetics* refers to the species in the reaction rate.

- Positive terms: Rate species are placed on right side of the reactions; reaction rate equation species are placed on the left.

$$kinetics \rightarrow \frac{dx}{dt}$$

- Negative terms: Rate species are placed on the left side of the reaction because the species are being used up in some way; reaction rate equation species are also placed on left. You need to deduce the products from additional information about the model.

$$kinetics \text{ or } \left(\frac{dx}{dt}\right) \rightarrow \text{products?}$$

The following table will help you deduce the products for a reaction. In this example, by convention, phosphate groups on the right side of a species name are activating while phosphate groups on left are inhibiting.

Enzyme	Description	Reaction
wee1	Kinase, add inhibiting phosphate group	MPF → P-MPF
cdc25	Phosphatase, remove inhibiting phosphate group	P-MPF → MPF + P
kca	Kinase, add activating phosphate group	MPF → MPFp
kpp	Phosphatase, remove activating phosphate group	MPF-P → MPF + P
MPF	Kinase, add activating or inhibiting phosphate group	Wee1/Cdc25/IE → X-P or P-X
ki	Add inhibiting Cki	Cki + MPF → Cki:MPF
kir	Remove inhibiting Cki	Cki:MPF → Cki + MPF

Equation 1, Cyclin B

Differential rate equation for cyclin B [Marlovits et al. 1998 on page B-41].

$$\frac{d[CycB]}{dt} = +k1 - k2[CycB] - k3[Cdc2][CycB]$$

Rate rule using SimBiology format for the differential rate equation 1. For a model using this rule, see “SimBiology Model with Rate and Algebraic Rules” on page B-25.

Rule 1 on page B-25 $[CycB] = k1 - K2*[CycB] - k3*[Cdc2]*[CycB]$

Reaction and reaction rate equations derived from the differential rate equation. For a model using these reactions, see “SimBiology Model with Reactions and Algebraic Rules” on page B-29.

Reaction 1 on page B-30	AA -> CycB	$v = k1$
Reaction 2 on page B-30	CycB -> AA	$v = K2*[CycB]$
Reaction 3 on page B-31	Cdc2 + CycB -> MPF	$v = k3*[Cdc2]*[CycB]$

Equation 2, M-Phase Promoting Factor

Differential rate equation for M-phase promoting factor (MPF) [Marlovits 1998 on page B-41]. Note that the parameter name *kcakr* [Marlovits et al. 1998 on page B-41] is changed to *kpp* [Borisuk 1998 on page B-41] in the following reaction equations. MPF is a heterodimer of cdc2 kinase and cyclin B.

$$\frac{d[MPF]}{dt} = +k3[Cdc2][CycB] - K2[MPF] \\ +kpp[MPFp] - kcak[MPF] \\ +Kcdc25[pMPF] - Kwee1[MPF] \\ +kir[Cki:MPF] - ki[MPF][Cki]$$

Rate rule using SimBiology format for the differential rate equation 1. For a model using this rule, see “SimBiology Model with Rate and Algebraic Rules” on page B-25.

Rule 2 on page B-26 $MPF = kpp*MPFp - (Kwee1 + kcak + K2)*MPF + Kcdc25*pMPF + k3*Cdc2*CycB$

Reaction and reaction rate equations derived from the differential rate equation. For a model using these reactions, see “SimBiology Model with Reactions and Algebraic Rules” on page B-29. A reaction name in parentheses denotes a reaction repeated in another differential rate equation.

(Reaction 3 on page B-31)	Cdc2 + CycB -> MPF	$v = k3*[Cdc2]*[CycB]$
Reaction 4 on page B-32	MPF -> Cdc2 + AA	$v = K2*[MPF]$
Reaction 5 on page B-33	MPFp -> MPF	$v = kpp*[MPFp]$
Reaction 6 on page B-34	MPF -> MPFp	$v = kcak*[MPF]$
Reaction 7 on page B-34	pMPF -> MPF	$v = Kcdc25*[pMPF]$
Reaction 8 on page B-35	MPF -> pMPF	$v = Kwee1*[MPF]$

Equation 3, Inhibited M-Phase Promoting Factor

Differential rate equation for inhibited M-phase promoting factor (pMPF) [Marlovits 1998 on page B-41].

$$\frac{d[pMPF]}{dt} = - K2[pMPF] \\ +kpp[pMPFp] - kcak[pMPF] \\ +Kwee1[MPF] - Kcdc25[pMPF] \\ +kd[Cki:pMPF]$$

Rate rule using SimBiology format for the differential rate equation 3. For a model using this rule, see “SimBiology Model with Rate and Algebraic Rules” on page B-25.

Rule 3 on page B-26 $pMPF = Kwee1*MPF - (Kcdc25 + kcak + K2)*pMPF + kpp*pMPFp$

Reaction and reaction rate equations derived from the differential rate equation. For a model using these reactions, see “SimBiology Model with Reactions and Algebraic Rules” on page B-29.

Reaction 11 on page B-36	pMPF -> Cdc2 + AA	$v = K2*[pMPF]$
Reaction 12 on page B-36	pMPFp -> pMPF	$v = kpp*[pMPFp]$

Reaction 13 on page B-36	pMPF -> pMPFp	v = kcak*[pMPF]
(Reaction 8 on page B-35)	MPF -> pMPF	v = Kwee1*[MPF]
(Reaction 7 on page B-34)	pMPF -> MPF	v = Kcdc25*[pMPF]

Equation 4, Inhibited and Activated M-Phase Promoting Factor

Differential rate equation for inhibited and activated M-phase promoting factor (pMPFp) [Marlovits 1998 on page B-41].

$$\frac{d[pMPFp]}{dt} = -K2[pMPFp] + kcak[pMPF] - kpp[pMPFp] + Kwee1[MPFp] - Kcdc25[pMPFp] + kd[Cki:pMPFp]$$

Rate rule using SimBiology format for the differential rate equation. For a model using this rule, see “SimBiology Model with Rate and Algebraic Rules” on page B-25.

Rule 4 on page B-28 $pMPFp = Kwee1*MPFp - (kpp + Kcdc25 + K2)*pMPFp + kcak*pMPF$

Reaction and reaction rate equations derived from the differential rate equation. For a model using these reactions, see “SimBiology Model with Reactions and Algebraic Rules” on page B-29.

Reaction 15 on page B-37	pMPFp -> Cdc2 + AA	v = K2*[pMPFp]
(Reaction 13 on page B-36)	pMPF -> pMPFp	v = kcak*[pMPF]
(Reaction 12 on page B-36)	pMPFp -> pMPF	v = kpp*[pMPFp]
Reaction 16 on page B-37	MPFp -> pMPFp	v = Kwee1*[MPFp]
Reaction 17 on page B-37	pMPFp -> MPFp	v = Kcdc25*[pMPFp]

Equation 5, Activated M-Phase Promoting Factor

Differential rate equation for activated M-phase promoting factor (MPFp) [Marlovits 1998 on page B-41].

$$\frac{d[MPFp]}{dt} = -K2[MPFp] + kcak[MPF] - kpp[MPFp] + Kcdc25[pMPFp] - Kwee1[MPFp] + kir[CKI:MPFp] - ki[CKI][MPFp]$$

Rate rule using SimBiology format for the differential rate equation 1. For a model using this rule, see “SimBiology Model with Rate and Algebraic Rules” on page B-25.

Rule 5 on page B-28 $MPFp = kcak*MPF - (kpp + Kwee1 + K2)*MPFp + Kcdc25*pMPFp$

Reaction and reaction rate equations derived from the differential rate equation. For a model using these reactions, see “SimBiology Model with Reactions and Algebraic Rules” on page B-29.

Reaction 19 on page B-38	MPFp -> MPF + AA	v = K2*[MPFp]
(Reaction 6 on page B-34)	MPF -> MPFp	v = kcak*[MPF]
(Reaction 5 on page B-33)	MPFp -> MPF	v = kpp*[MPFp]
(Reaction 17 on page B-37)	pMPFp -> MPFp	v = Kcdc25*[pMPFp]
(Reaction 16 on page B-37)	MPFp -> pMPFp	v = Kwee1*[MPFp]

Equation 11, Cell Division Control 25

Differential rate equation for activating and deactivating Cdc25 [Marlovits 1998 on page B-41].

$$\frac{d[\text{Cdc25p}]}{dt} = + \frac{k_{25}[\text{MPFp}][\text{Cdc25}]}{K_{m25} + [\text{Cdc25}]} - \frac{k_{25r}[\text{Cdc25p}]}{K_{m25r} + [\text{Cdc25p}]}$$

Rate rule in SimBiology format for the differential rate equation 1. For a model using this rule, see “SimBiology Model with Rate and Algebraic Rules” on page B-25. Note that since there isn't a rate rule for Cdc25, its amount is written as (TotalCdc25 - Cdc25p).

Rule 11 on page B-28 $\text{Cdc25p} = (k_{25} * \text{MPFp} * (\text{TotalCdc25} - \text{Cdc25p})) / (K_{m25} + (\text{TotalCdc25} - \text{Cdc25p})) -$

Reaction and reaction rate equations derived from the differential rate equation. For a model using these reactions, see “SimBiology Model with Reactions and Algebraic Rules” on page B-29.

Reaction 36 $\text{Cdc25} \rightarrow \text{Cdc25p}$, $v = k_{25} * [\text{MPFp}] * [\text{Cdc25}] / (K_{m25} + [\text{Cdc25}])$
 Reaction 37 $\text{Cdc25p} \rightarrow \text{Cdc25}$, $v = k_{25r} * [\text{Cdc25p}] / (K_{m25r} + [\text{Cdc25p}])$

Equation 12, Wee1 Activation/Deactivation

Differential rate equation for activating and deactivating Wee1 kinase [Marlovits 1998 on page B-41]. The kinase (MPFp) phosphorylates active Wee1 (Wee1) to its inactive form (Wee1p). The dephosphorylation of inactive Wee1 (Wee1p) is by an unknown phosphatase.

$$\frac{d[\text{Wee1}]}{dt} = - \frac{k_w[\text{MPFp}][\text{Wee1}]}{K_{mw} + [\text{Wee1}]} + \frac{k_{wr}[\text{Wee1p}]}{K_{mwr} + [\text{Wee1p}]}$$

Rate rule in SimBiology format for the differential rate equation 1. For a model using this rule, see “SimBiology Model with Rate and Algebraic Rules” on page B-25.

Rule 12 $\text{Wee1p} = (k_w * \text{MPFp} * (\text{TotalWee1} - \text{Wee1p})) / (K_{mw} + (\text{TotalWee1} - \text{Wee1p})) -$
 $(k_{wr} * \text{Wee1p}) / (K_{mwr} + \text{Wee1p})$

Reaction and reaction rate equations derived from the differential rate equation. For a model using these reactions, see “SimBiology Model with Reactions and Algebraic Rules” on page B-29.

reaction 38 $\text{Wee1} \rightarrow \text{Wee1p}$, $v = (k_w * [\text{MPFp}] * [\text{Wee1}]) / (K_{mw} + [\text{Wee1}])$
 reaction 39 $\text{Wee1p} \rightarrow \text{Wee1}$, $v = (k_{wr} * [\text{Wee1p}]) / (K_{mwr} + [\text{Wee1p}])$

Equation 13, Intermediate Enzyme Activation/Deactivation

Differential rate equation for activating and deactivating the intermediate enzyme (IE) [Marlovits 1998 on page B-41]. The active kinase (MPFp) phosphorylates the inactive intermediate enzyme (IE) to its active form (IEp).

$$\frac{d[\text{IEp}]}{dt} = + \frac{k_{ie}[\text{MPFp}][\text{IE}]}{K_{mie} + [\text{IE}]} - \frac{k_{ier}[\text{IEp}]}{K_{mier} + [\text{IEp}]}$$

Rate rule in SimBiology format for the differential rate equation 1. For a model using this rule, see “SimBiology Model with Rate and Algebraic Rules” on page B-25.

Rule 13 $\text{IEp} = (k_{ie} * \text{MPFp} * (\text{TotalIE} - \text{IEp})) / (K_{mie} + (\text{TotalIE} - \text{IEp})) -$
 $(k_{ier} * \text{IEp}) / (K_{mier} + \text{IEp})$

Reaction and reaction rate equations derived from the differential rate equation. For a model using these reactions, see “SimBiology Model with Reactions and Algebraic Rules” on page B-29.

reaction 40 IE -> IEp, $v = (kie*[MPFp]*[IE])/(Kmie + [IE])$
 reaction 41 IEp -> IE, $v = (kier*[IEp])/(Kmier + [IEp])$

Equation 14, APC Activation/Deactivation

Differential rate equation for [Marlovits 1998 on page B-41].

$$\frac{d[APCa]}{dt} = + \frac{kap[IEp][APCi]}{Kmap + [APCi]} - \frac{kapr[APCa]}{Kmapr + [APCa]}$$

Rate rule in SimBiology format for the differential rate equation 1. For a model using this rule, see “SimBiology Model with Rate and Algebraic Rules” on page B-25.

Rule 14 APCa = (kap*IEp*(TotalAPC - APCa))/(Kmap + (TotalAPC - APCa))
 - (kapr*APCa)/(Kmapr + APCa)

Reaction and reaction rate equations derived from the differential rate equation. For a model using these reactions, see “SimBiology Model with Reactions and Algebraic Rules” on page B-29.

Reaction 42 APCi -> APCa, $v = (kap*[IEp]*[APCi])/(Kmap + [APCi])$
 Reaction 43 APCa -> APCi, $v = (kapr*[APCa])/(Kmapr + [APCa])$

Equation 17, Rate Parameter K2

Algebraic equation to define the rate parameter K2 [Marlovits 1998 on page B-41]. Inactive APC (APCi) is catalyzed by IE (intermediate enzyme) to active APC (APCa).

$$k2 = V2'[APC] + V2''[APC']$$

Algebraic rule in SimBiology format for the algebraic equation 17. For a model using this rule, see “SimBiology Model with Rate and Algebraic Rules” on page B-25.

Algebraic Rule 17 $V2i*(TotalAPC - APCa) + V2a*APCa - K2$

Algebraic rule when simulating with reactions. For a model using this rule with reactions, see “SimBiology Model with Reactions and Algebraic Rules” on page B-29. V2' is renamed to V2i and V2" is renamed to V2a. APCi (APC) is the inactive form of the enzyme while APCa (APC') is the active form. K2 is the independent variable.

Algebraic Rule 1 $(V2i*APCi) + (V2a*APCa) - K2$

Equation 18, Rate Parameter Kcdc25

Algebraic equation to define the rate parameter Kcdc25 [Marlovits 1998 on page B-41]. Inactive Cdc25 (Cdc25) is phosphorylated by MPF to active Cdc25 (Cdc25p).

$$kcdc25 = V25'[Cdc25] + V25''[Cdc25p]$$

Algebraic rule in SimBiology format for the algebraic equation 18. For a model using this rule, see “SimBiology Model with Rate and Algebraic Rules” on page B-25.

Algebraic Rule 18 $V25i*(TotalCdc25 - Cdc25p) + V25a*Cdc25p - Kcdc25$

Algebraic rule when simulating with reactions. Kcdc25 is the independent variable. For a model using this rule with reactions, see “SimBiology Model with Reactions and Algebraic Rules” on page B-29.

Algebraic Rule 2 $(V25i*Cdc25) + (V25a*Cdc25p) - Kcdc25$

Equation 19, Rate Parameter Kwee1

Algebraic equation to define the rate parameter [Marlovits 1998 on page B-41]. Active Wee1 (Wee1) is phosphorylated by MPF to inactive Wee1 (Wee1p).

$$kwee1 = Vwee1'[Wee1p] + Vwee1''[Wee1]$$

Algebraic rule in SimBiology format for rate parameter equation 19. For a model using this rule, see “SimBiology Model with Rate and Algebraic Rules” on page B-25.

Algebraic Rule 19 $Vwee1i*Wee1p + Vwee1a*(TotalWee1 - Wee1p) - Kwee1$

Algebraic rule when simulating with reactions. Kwee1 is the independent variable. For a model using this rule with reactions, see “SimBiology Model with Reactions and Algebraic Rules” on page B-29.

Algebraic Rule 3 $(Vwee1i*Wee1p) + (Vwee1a*Wee1) - Kwee1$

SimBiology Model with Rate and Algebraic Rules

- “Overview” on page B-25
- “Writing Differential Rate Equations as Rate Rules” on page B-25
- “Species” on page B-26
- “Parameters” on page B-26
- “Rate Rule 1, Cyclin B (CycB)” on page B-27
- “Rate Rule 2, M-Phase Promoting Factor (MPF)” on page B-27
- “Rate Rule 3, Inhibited M-Phase Promoting Factor (pMPF)” on page B-28
- “Rate Rule 4, Activated but Inhibited M-Phase Promoting Factor (pMPFp)” on page B-28
- “Rate Rule 5, Activated M-Phase Promoting Factor (MPFp)” on page B-28
- “Rate Rule 11, Activated Cdc25 (Cdc25p)” on page B-28
- “Rate Rule 12, Inhibited Wee1 (Wee1p)” on page B-28
- “Rate Rule 13, Activated Intermediate Enzyme (IEp)” on page B-28
- “Rate Rule 14, Activated APC (APCa)” on page B-28
- “Algebraic Rule 17, Rate Parameter K2” on page B-29
- “Algebraic Rule 18, Rate Parameter Kcdc25” on page B-29
- “Algebraic Rule 19, Rate Parameter Kwee1” on page B-29

Overview

There is one rate rule for each equation defining a species and one algebraic rule for each variable parameter in the M-phase control model [Marlovits 1998 on page B-41]. For a list and description of the equations, see “M-Phase Control Equations” on page B-19.

A basic model includes rate rules 1 to 5 and 11 to 14 with algebraic rules 17, 18, and 19.

Writing Differential Rate Equations as Rate Rules

Writing differential rate equations in an unambiguous format that a software program can understand is a simple process when you follow the syntax rules for programming languages.

- Use an asterisk to indicate multiplication. For example, $k[A]$ is written $k*A$ or $k*[A]$. The brackets around the species A do not indicate concentration.
- SimBiology uses square brackets around species and parameter name to allow names that are not valid MATLAB variable names. For example, you could have a species named `glucose-6-phosphate dehydrogenase` but you need to add brackets around the name in reaction rate and rule equations.

[glucose-6-phosphate dehydrogenase]

- Use parentheses to clarify the order of evaluation for mathematical operations. For example, do not write Henri-Michaelis-Menten reaction rates as $V_m*C/K_d + C$, because V_m*C is divided by K_d before adding C to the result. Instead, write this reaction rate as $(V_m*C)/(K_d + C)$.

Species

The following table lists species in the model with their initial amounts. There are three variable parameters modeled as species (K2, Kcdc25, and Kwee1). You could also model the variable parameters as parameters with the property **ConstantAmount** cleared.

Name	InitialAmount Δ	InitialAmountUnits	ConstantAmount
CycB	0.0		<input type="checkbox"/>
MPF	0.0		<input type="checkbox"/>
pMPF	0.0		<input type="checkbox"/>
pMPFp	0.0		<input type="checkbox"/>
MPFp	0.0		<input type="checkbox"/>
Cdc25p	0.0		<input type="checkbox"/>
Wee1p	0.0		<input type="checkbox"/>
IEp	0.0		<input type="checkbox"/>
APCa	0.0		<input type="checkbox"/>
Kcdc25	0.0		<input type="checkbox"/>
Kwee1	0.0		<input type="checkbox"/>
K2	0.0		<input type="checkbox"/>
Wee1	0.0		<input type="checkbox"/>
TotalCdc25	1.0		<input checked="" type="checkbox"/>
TotalWee1	1.0		<input checked="" type="checkbox"/>
TotalAPC	1.0		<input checked="" type="checkbox"/>
TotalIE	1.0		<input type="checkbox"/>
PPase	1.0		<input checked="" type="checkbox"/>
AntiAPC	1.0		<input checked="" type="checkbox"/>
Cdc2	100.0		<input checked="" type="checkbox"/>

Parameters

The following table lists parameters in the model with their initial values. The property **ConstantValue** is selected for all of the parameters.

Name	Value ▾	ValueUnits	ConstantValue
Vweea	1.0		<input checked="" type="checkbox"/>
k1	1.0		<input checked="" type="checkbox"/>
Kmwr	1.0		<input checked="" type="checkbox"/>
Kmapr	1.0		<input checked="" type="checkbox"/>
Km25r	1.0		<input checked="" type="checkbox"/>
kcak	0.64		<input checked="" type="checkbox"/>
V2a	0.25		<input checked="" type="checkbox"/>
V25a	0.17		<input checked="" type="checkbox"/>
kier	0.15		<input checked="" type="checkbox"/>
kapr	0.13		<input checked="" type="checkbox"/>
kap	0.13		<input checked="" type="checkbox"/>
kwr	0.1		<input checked="" type="checkbox"/>
k25r	0.1		<input checked="" type="checkbox"/>
Kmw	0.1		<input checked="" type="checkbox"/>
Km25	0.1		<input checked="" type="checkbox"/>
kie	0.02		<input checked="" type="checkbox"/>
kw	0.02		<input checked="" type="checkbox"/>
k25	0.02		<input checked="" type="checkbox"/>
V25i	0.017		<input checked="" type="checkbox"/>
Vweei	0.01		<input checked="" type="checkbox"/>
Kmier	0.01		<input checked="" type="checkbox"/>
Kmie	0.01		<input checked="" type="checkbox"/>
Kmap	0.01		<input checked="" type="checkbox"/>
V2i	0.0050		<input checked="" type="checkbox"/>
k3	0.0050		<input checked="" type="checkbox"/>
kpp	0.0040		<input checked="" type="checkbox"/>

Rate Rule 1, Cyclin B (CycB)

The rate rule is from “Equation 1, Cyclin B” on page B-20.

rate rule: $\text{CycB} = k1 - K2 \cdot \text{CycB} - k3 \cdot \text{Cdc2} \cdot \text{CycB}$
species: $\text{CycB} = 0 \text{ nM}$
 $\text{Cdc2} = 100 \text{ nM}$, [x]constant
parameters: $k1 = 1 \text{ nM/minute}$
 $K2 = 0 \text{ 1/minute}$, []constant
 $k3 = 0.005 \text{ 1/(nM*minute)}$

K2 is a variable rate parameter whose value is defined by an algebraic rule. See “Algebraic Rule 17, Rate Parameter K2” on page B-29. Its value varies from 0.005 to 0.25 1/minute.

Rate Rule 2, M-Phase Promoting Factor (MPF)

The rate rule is from “Equation 2, M-Phase Promoting Factor” on page B-21.

rate rule: $\text{MPF} = kpp \cdot \text{MPFp} - (Kwee1 + kcak + K2) \cdot \text{MPF} + Kcdc25 \cdot \text{pMPF}$
 $+ k3 \cdot \text{Cdc2} \cdot \text{CycB}$

```

species: MPF = 0 nM
         MPFp = 0 nM
         pMPF = 0 nM
parameters: kpp = 0.004 1/minute
           kcak = 0.64 1/minute
           k3 = 0.005 1/(nM*minute)
           K2 = 0 1/minute
           Kcdc25 = 0 1/minute
           Kwee1 = 0 1/minute

```

K2, Kcdc25, and Kwee1 are variable rate parameters whose values are defined by algebraic rules. See “Algebraic Rule 17, Rate Parameter K2” on page B-29, “Algebraic Rule 18, Rate Parameter Kcdc25” on page B-29, and “Algebraic Rule 19, Rate Parameter Kwee1” on page B-29.

Rate Rule 3, Inhibited M-Phase Promoting Factor (pMPF)

The rate rule is from “Equation 3, Inhibited M-Phase Promoting Factor” on page B-21.

rate rule: $pMPF = Kwee1*MPF - (Kcdc25 + kcak + K2)*pMPF + kpp*pMPFp$

Rate Rule 4, Activated but Inhibited M-Phase Promoting Factor (pMPFp)

The rate rule is from “Equation 4, Inhibited and Activated M-Phase Promoting Factor” on page B-22.

rate rule: $pMPFp = Kwee1*MPFp - (kpp + Kcdc25 + K2)*pMPFp + kcak*pMPF$

Rate Rule 5, Activated M-Phase Promoting Factor (MPFp)

The rate rule is from “Equation 5, Activated M-Phase Promoting Factor” on page B-22.

rate rule: $MPFp = kcak*MPF - (kpp + Kwee1 + K2)*MPFp + Kcdc25*pMPFp$

Rate Rule 11, Activated Cdc25 (Cdc25p)

The rate rule is from “Equation 11, Cell Division Control 25” on page B-23.

rate rule: $Cdc25p = (k25*MPFp*(TotalCdc25 - Cdc25p))/(Km25 + (TotalCdc25 - Cdc25p)) - (k25r*PPase*Cdc25p)/(Km25r + Cdc25p)$

Rate Rule 12, Inhibited Wee1 (Wee1p)

The rate rule is from “Equation 12, Wee1 Activation/Deactivation” on page B-23.

rate rule: $Wee1p = (kw*MPFp*(TotalWee1 - Wee1p))/(Kmw + (TotalWee1 - Wee1p)) - (kwr*PPase*Wee1p)/(Kmwr + Wee1p)$

Rate Rule 13, Activated Intermediate Enzyme (IEp)

The rate rule is from “Equation 13, Intermediate Enzyme Activation/Deactivation” on page B-23.

rate rule: $IEp = (kie*MPFp*(TotalIE - IEp))/(Kmie + (TotalIE - IEp)) - (kier*PPase*IEp)/(Kmier + IEp)$

Rate Rule 14, Activated APC (APCa)

The rate rule is from “Equation 14, APC Activation/Deactivation” on page B-24.

rate rule: $APCa = (kap*IEp*(TotalAPC - APCa))/(Kmap + (TotalAPC - APCa)) - (kapr*AntiAPC*APCa)/(Kmapr + APCa)$

Algebraic Rule 17, Rate Parameter K2

K2 is a variable rate parameter whose value is determined by the amount of active and inactive APC. The algebraic rule is from “Equation 17, Rate Parameter K2” on page B-24.

```
algebraic rule: V2i*(TotalAPC - APCa) + V2a*APCa - K2
  species: APCi = 1 nM
           APCa = 0 nM
           TotalAPC = 1 nM [x]constant
  parameters: K2 = 0 or 0.25 1/minute, []constant
             V2i = 0.005 1/(nM*minute)
             V2a = 0.25 1/(nM*minute)
```

Algebraic Rule 18, Rate Parameter Kcdc25

Kcdc25 is a variable rate parameter whose value is determined by the amount of active and inactive Cdc25. The algebraic rule is from “Algebraic Rule 18, Rate Parameter Kcdc25” on page B-29.

```
algebraic rule: V25i*(TotalCdc25 - Cdc25p) + V25a*Cdc25p - Kcdc25
```

Algebraic Rule 19, Rate Parameter Kwee1

Kwee1 is a variable rate parameter whose value is determined by the amount of active and inactive Wee1. The algebraic rule is from “Equation 19, Rate Parameter Kwee1” on page B-25.

```
algebraic rule: Vweei*Wee1p + Vweea*(TotalWee1 - Wee1p) - Kwee1
```

SimBiology Model with Reactions and Algebraic Rules

- “Overview” on page B-30
- “Reaction 1, Synthesis of Cyclin B” on page B-30
- “Reaction 2, Degradation of Cyclin B” on page B-30
- “Reaction 3, Dimerization of Cyclin B with Cdc2 Kinase” on page B-31
- “Reaction 4, Degradation of Cyclin B on MPF” on page B-32
- “Reaction 5, Deactivation of Active MPF” on page B-33
- “Reaction 6, Activation of MPF” on page B-34
- “Reaction 7, Remove Inhibiting Phosphate from Inhibited MPF” on page B-34
- “Reaction 8, Inhibition of MPF by Phosphorylation” on page B-35
- “Reaction 11, Degradation of Cyclin B on Inhibited MPF” on page B-36
- “Reaction 12, Deactivation of MPF to Inhibited MPF” on page B-36
- “Reaction 13, Activation of Inhibited MPF” on page B-36
- “Reaction 15, Degradation of Cyclin B on Active but Inhibited MPF” on page B-37
- “Reaction 16, Inhibit MPF by Phosphorylation” on page B-37
- “Reaction 17, Remove Inhibiting Phosphate from Activated MPF” on page B-37
- “Reaction 19, Degradation of Cyclin B on Activated MPF” on page B-38
- “Reaction 36, Activation of Cdc25 by Activated MPF” on page B-38
- “Reaction 37, Deactivation of Cdc25” on page B-38
- “Reaction 38, Deactivation of Wee1 by Active MPF” on page B-38

- “Reaction 39, Activation of Wee1” on page B-38
- “Reaction 40, Activation of Intermediate Enzyme by Active MPF” on page B-39
- “Reaction 41, Deactivation of IE” on page B-39
- “Reaction 42, APC Activation by IEp” on page B-39
- “Reaction 43, APC Deactivation” on page B-39
- “Block Diagram of the M-Phase Control Model with Reactions” on page B-39

Overview

There can be one or more reactions for an equation defining a species and one algebraic rule for each variable parameter in the M-phase control model [Marlovits 1998 on page B-41]. For a list and description of the equations, see “M-Phase Control Equations” on page B-19.

A basic model includes reactions 1 to 8, 11 to 13, 15 to 17, 19, and 36 to 43 with algebraic rules from equations 17, 18, and 19.

Reaction 1, Synthesis of Cyclin B

Cyclin B is synthesized at a constant rate.

```
reaction: AA -> CycB
reaction rate: k1 nM/minute
parameter: k1 = 1 nM/minute
species: CycB = 0 nM
          AA = 100 nM [x]constant [x]boundary
```

Simulate reaction 1 with the sundials solver.

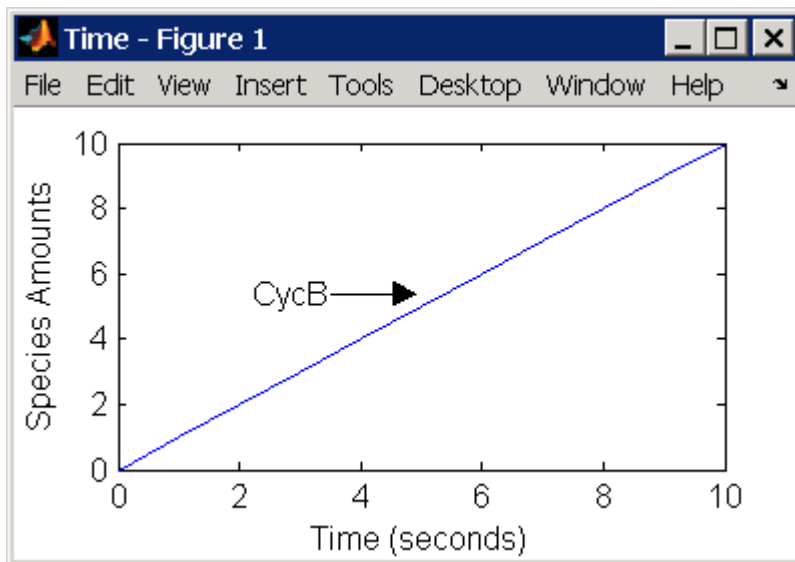

Reaction 2, Degradation of Cyclin B

Cyclin B is degraded at the end of the M-phase.

```
reaction: CycB -> AA
reaction rate: K2*CycB nM/minute
```

```

parameters: K2 = 0 1/minute, []constant, variable by rule
            V2i = 0.005 1/nM*minute
            V2a = 0.25 1/nM*minute
species: CycB = 0 nM
        APCi = 1 nM
        APCa = 0 nM
        AA = 100 nM [x]constant [x]boundary
algebraic rule: (V2i*APCi) + (V2a*APCa) - K2

```

Initially, Cyclin B degradation is low. This implies the amount of active APC (APCa) = 0 and inactive APC (APCi) = APCTotal = 1 nM.

Test the algebraic rule by simulating reactions 1 and 2 with APCi = 0 and APCa = 1.

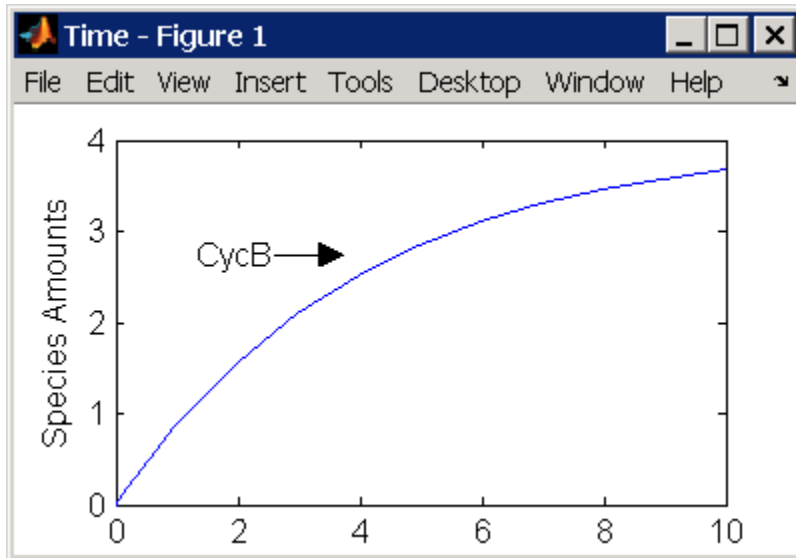

Reaction 3, Dimerization of Cyclin B with Cdc2 Kinase

Cyclin B dimerizes with Cdc2 kinase to form M-phase promoting factor (MPF).

```

reaction: Cdc2 + CycB -> MPF
reaction rate: k3*Cdc2*CycB nM/minute
parameters: k3 = 0.005 1/(nM*minute)
species: Cdc2 = 100 nM
        CycB = 0 nM
        MPF = 0 nM

```

Test the model by simulating with K2 = 0.25.

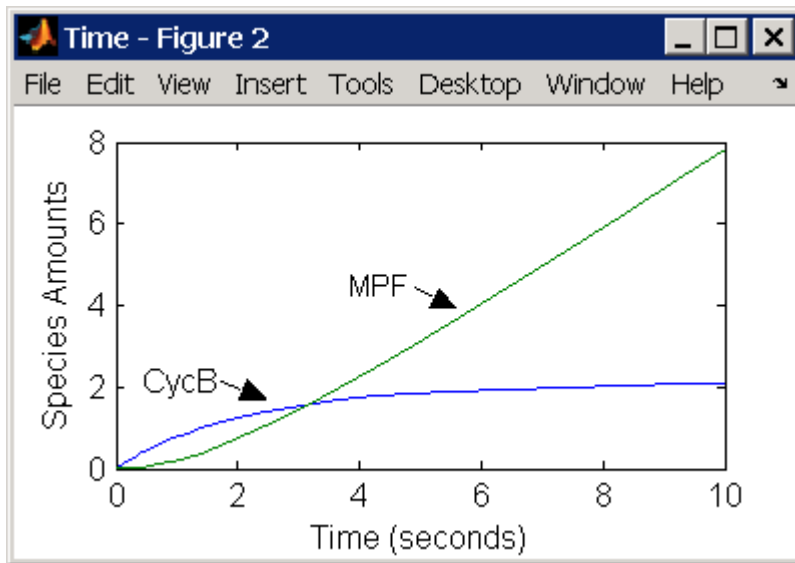

Reaction 4, Degradation of Cyclin B on MPF

Cyclin B is tagged with ubiquitin groups and degrades while bound to Cdc2.

```

reaction: MPF -> Cdc2 + AA
reaction rate: K2*[MPF]
parameters: K2 = 0 or 0.25 1/minute, variable by rule
             v2i = 0.005 1/(nM*minute)
             v2a = 0.25 1/(nM*minute)
species: MPF = 0 nM
          APCi = 1 nM
          APCa = 0 nM
          AA = 100 nM [x]constant [x]boundary
algebraic rule: (v2i*APCi) + (v2a*APCa) - K2
    
```

Test the simulation with APCa = 1 and APCi = 0. Because the amount of APCa (active) is high, K2 increases and the degradation starts to balance the synthesis of MPF.

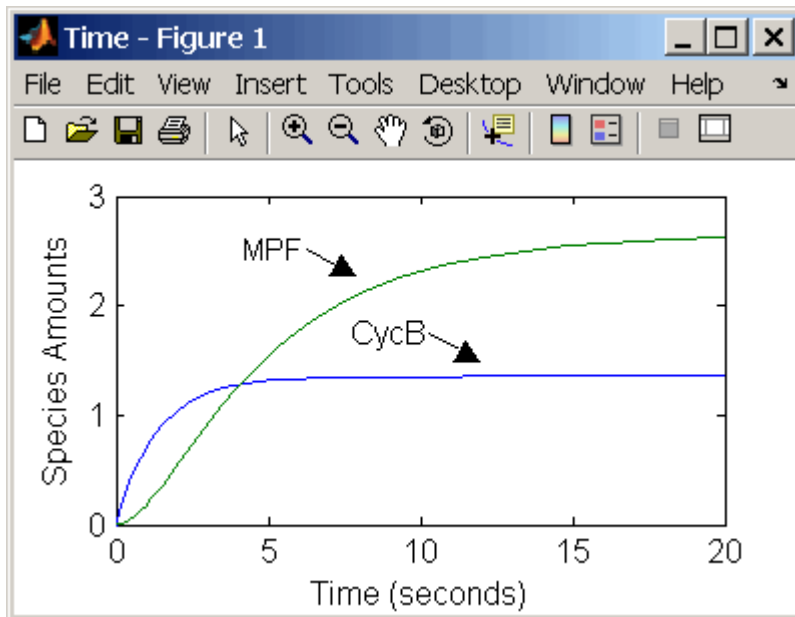

Reaction 5, Deactivation of Active MPF

Active MPF (MPFp) is dephosphorylated on Thr-161 by an unknown phosphatase (PP) to inactive MPF (MPF).

```

reaction: MPFp -> MPF
reaction rate: kpp*[MPFp]
parameters: kpp = 0.004 1/minute
species: MPFp = 0 nM
          MPF = 0 nM
    
```

$k_{cacr} = 0.004$ 1/minute [Marlovits 1998, p. 175], but is renamed to k_{pp} [Borisuk 1998].

Test simulation with $APCa = 1$ and $APCi = 0$. MPF increases without reaching steady state.

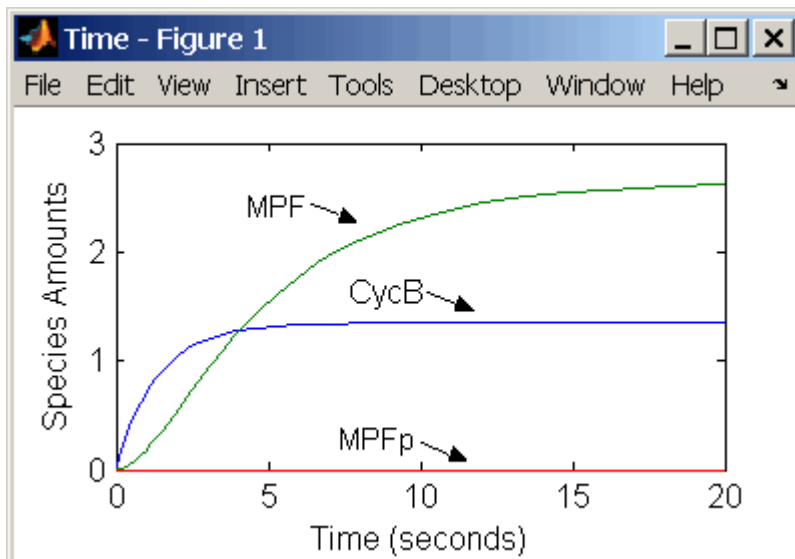

Reaction 6, Activation of MPF

Inactive MPF (MPF) is phosphorylated on Thr-161 by an unknown cyclin activating kinase (CAK).

```

reaction: MPF -> MPFp
reaction rate: kca*[MPF]
parameters: kca = 0.64 1/minute
species: MPF = 0 nM
           MPFp = 0 nM
    
```

The kinase reaction that phosphorylates MPF to the active form is 160 times faster than the phosphatase reaction that dephosphorylates active MPF.

Simulate the model with reactions 1 to 6. Notice that after adding reaction 6, most of the product goes to active MPF (MPFp).

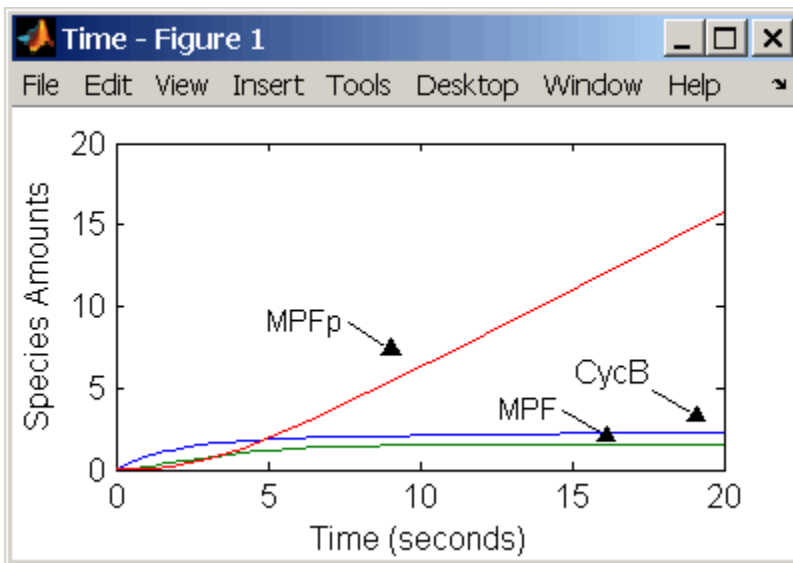

Reaction 7, Remove Inhibiting Phosphate from Inhibited MPF

Cdc25 phosphatase removes the inhibiting phosphate groups at the threonine 14 and tyrosine 15 residues on Cdc2 kinase.

```

reaction: pMPF -> MPF
reaction rate: Kcdc25*[pMPF]
parameters: Kcdc25 = 0.0 1/minute or 0.017 1/minute, variable by
                                                    algebraic rule
           V25i = 0.017 1/(mM*minute)
           V25a = 0.17 1/mM*minute
species: pMPF = 0 nM
           MPF = 0 nM
           Cdc25 = 1 nM (inactive)
           Cdc25p = 0 nM (active)
algebraic rule: (V25i*Cdc25) + (V25a*Cdc25p) - Kcdc25
    
```

Initially, all of the Cdc25 phosphatase is in the inactive form (Cdc25).

Enter the initial value for K_{cdc25} as 0.0 and let the first time step calculate the value from the rule, or enter an initial value using the rule.

Initially, set **ConstantAmount** for Cdc25 and Cdc25p to test reactions 1 through 7. Then after you can add the reactions to regulate the Cdc25 phosphatase by clearing the **ConstantAmount** property.

Reaction 8, Inhibition of MPF by Phosphorylation

Addition of inhibiting phosphate groups by Wee1 kinase to inhibit active M-phase promoting factor (MPF). Myt1 kinase is also involved with the phosphorylation, but its contribution is grouped with Wee1.

```

reaction: MPF -> pMPF
reaction rate: Kweel*[MPF]
parameters: Kweel = 0.0 1/minute or 0.01 1/minute, variable by
              algebraic rule
              Vweeli = 0.01 1/(nM*minute)
              Vweela = 1.0 1/(nM*minute)
species: MPF = 0 nM
         pMPF = 0 nM
         Weelp = 1 nM (inactive)
         Weel = 0 nM (active)
algebraic rule: (Vweeli*Weelp) + (Vweela*Weel) - Kweel

```

The initial capitalization for the parameter Kweel is a convention to indicate that this value changes during the simulation.

Test the simulation for reactions 1 through 8 with Weelp (inactive) = 1 and Weel (active) = 0.

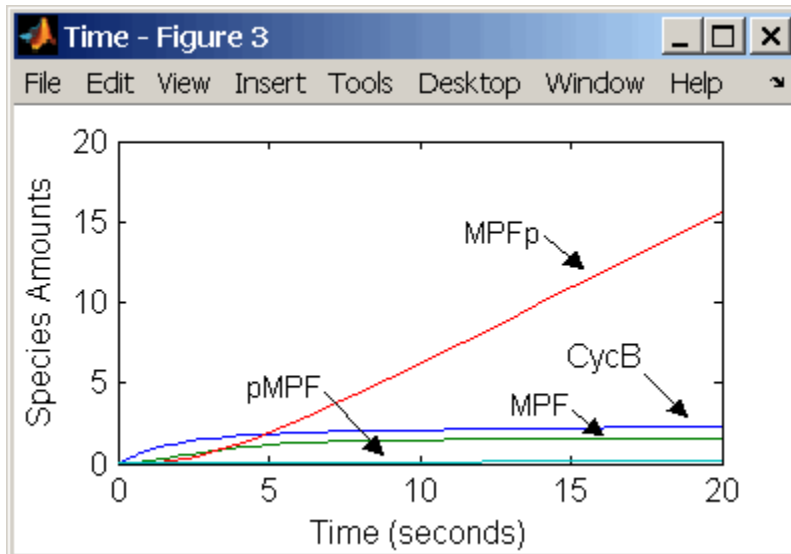

Test the simulation with Weelp (inactive) = 0 and Weel (active) = 1.

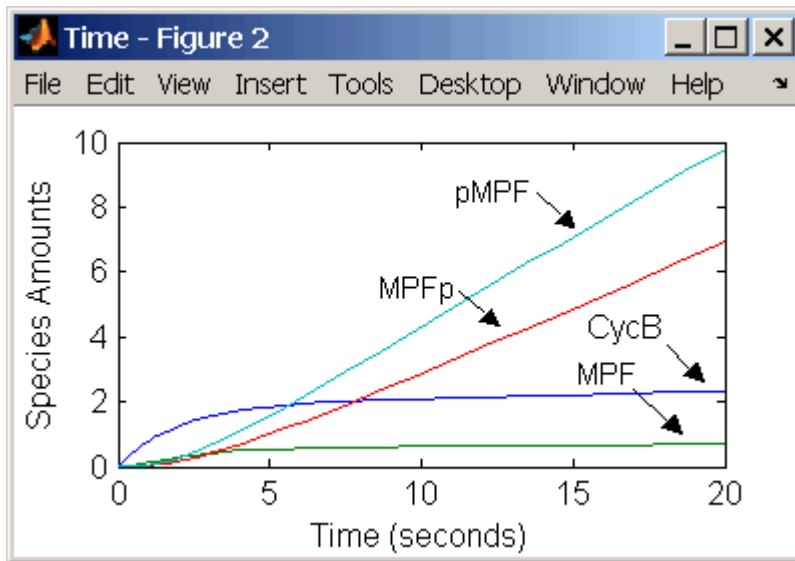

Reaction 11, Degradation of Cyclin B on Inhibited MPF

Degradation of cyclin B (CycB) on inhibited MPF (pMPF). Cyclin B is tagged with ubiquitin groups and degrades while bound to Cdc2.

```

reaction: pMPF -> Cdc2 + AA
reaction rate: K2*[pMPF] nM/minute
parameters: K2 = 0 or 0.25 1/minute, variable by rule
            V2i = 0.005 1/nM*minute
            V2a = 0.25 1/nM*minute
species: MPF = 0 nM
         APCi = 1 nM
         APCa = 0 nM
         AA = 100 nM [x]constant [x]boundary
         Cdc2 = 100 nm
algebraic rule: (V2i*APCi) + (V2a*APCa) - K2
    
```

Test the simulation with Wee1 active (Wee1 = 1) and APC active (APCi = 1).

Reaction 12, Deactivation of MPF to Inhibited MPF

Inhibited/active MPF (pMPFp) is dephosphorylated on Thr-161 by an unknown phosphatase (PP) to inhibited MPF (pMPF). Compare reaction 12 with reaction 5 on page B-33.

```

reaction: pMPFp -> pMPF
reaction rate: kpp*[pMPFp]
parameters: kpp = 0.004 1/minute
species: pMPFp = 0 nM
         pMPF = 0 nM
    
```

Reaction 13, Activation of Inhibited MPF

Inhibited MPF (pMPF) is phosphorylated on Thr-161 by an unknown cyclin-activating kinase (CAK). Compare reaction 13 with reaction 6 on page B-34.

```

reaction: pMPF -> pMPFp
reaction rate: kcak*[pMPF] nM/minute
    
```

```

parameters: kcaK = 0.64 1/minute
species: pMPF = 0 nM
pMPFp = 0 nM

```

Test the simulation with Wee1p = 1 (inactive)/ Wee1 = 0 and then test with Wee1p = 0 (inactive)/ Wee1 = 1.

Reaction 15, Degradation of Cyclin B on Active but Inhibited MPF

Degradation of cyclin B (CycB) on inhibited MPF (pMPF). Cyclin B is tagged with ubiquitin groups and degrades while bound to cdc2 kinase.

```

reaction: pMPFp -> Cdc2 + AA
reaction rate: K2*[pMPFp] nM/minute
parameters: K2 = 0 or 0.25 1/minute, variable by rule
v2i = 0.005 1/nM*minute
v2a = 0.25 1/nM*minute
species: MPF = 0 nM
APCi = 1 nM
APCa = 0 nM
AA = 100 nM [x]constant [x]boundary
Cdc2 = 100 nm
algebraic rule: (V2i*APCi) + (V2a*APCa) - K2

```

Reaction 16, Inhibit MPF by Phosphorylation

Addition of inhibiting phosphate groups by Wee1 kinase to inhibit active M-phase promoting factor (MPF). Myt1 kinase is also involved with the phosphorylation, but its contribution is grouped with Wee1.

```

reaction: MPFp -> pMPFp
reaction rate: Kwee1*[MPFp] nM/minute
parameters: Kwee1 = 1/minute [ ]constant, variable by rule
Vweei = 0.01 1/nM*minute
Vweea = 1 1/nM*minute
species: MPFp = 0 nM
pMPFp = 0 nM
Wee1p = 1 nM (inactive)
Wee1 = 0 nM (active)
algebraic rule: (Vweei*Wee1p) + (Vweea*Wee1) - Kwee1

```

Reaction 17, Remove Inhibiting Phosphate from Activated MPF

Remove the inhibiting phosphate group from pMPFp with cdc25 phosphatase.

```

reaction: pMPFp -> MPFp
reaction rate: Kcdc25*[pMPFp]
parameters: Kcdc25 = 0 1/minute, [ ]constant, variable by rule
V25i = 0.017 1/nM*minute
V25a = 0.17 1/nM*minute
species: pMPFp = 0 nM
MPFp = 0 nM
algebraic rule: (V25i*Cdc25) + (V25a*Cdc25p) - Kcdc25

```

Reaction 19, Degradation of Cyclin B on Activated MPF

Degradation of cyclin B (CycB) on inhibited MPF (pMPF). Cyclin B is tagged with ubiquitin groups and degrades while bound to cdc2 kinase.

```
reaction: MPFp -> MPF + AA
reaction rate: K2*[MPFp] nM/minute
parameters: K2 = 0 or 0.25 1/minute, variable by rule
            V2i = 0.005 1/nM*minute
            V2a = 0.25 1/nM*minute
species: MPF = 0 nM
         MPFp = 0 nM
         APCi = 1 nM
         APCa = 0 nM
         AA = 100 nM [x]constant [x]boundary
         Cdc2 = 100 nm
algebraic rule: (V2i*APCi) + (V2a*APCa) - K2
```

Reaction 36, Activation of Cdc25 by Activated MPF

Activation of cdc25 phosphatase by phosphorylation with active M-phase promoting factor (MPFp).

```
reaction: Cdc25 + (MPFp) -> Cdc25p + (MPFp)
reaction rate: (k25*[MPFp]*[Cdc25])/(Km25 + [Cdc25])
parameters: k25 = 0.02 1/minute
            Km25 = 0.1 nM
species: Cdc25 = 1 nM (inactive)
         Cdc25p = 0 nM (active)
```

Initially MPF is inhibited (MPF* reacts to pMPF*).

Reaction 37, Deactivation of Cdc25

Deactivation of cdc25 phosphatase by dephosphorylation with an unknown phosphatase.

```
reaction: Cdc25p -> Cdc25
reaction rate: (k25r*[Cdc25p])/(Km25r + [Cdc25p])
parameters: k25r = 0.1 nM/minute
            Km25r = 1 nM
species: Cdc25 = 1 nM (inactive)
         Cdc25p = 0 nM (active)
```

Reaction 38, Deactivation of Wee1 by Active MPF

Deactivation of Wee1 kinase by phosphorylation with active M-phase promoting factor (MPFp).

```
reaction: Wee1 + (MPFp) -> Wee1p + (MPFp)
reaction rate: (kw*[MPFp]*[Wee1])/(Kmw + [Wee1]) nM/minute
parameters: kw = 0.02 1/minute
            Kmw = 0.1 nM
species: Wee1p = 1 nM (inactive)
         Wee1 = 0 nM (active)
```

Initially MPF is inhibited (MPF* reacts to pMPF*).

Reaction 39, Activation of Wee1

Activation of Wee1 kinase by dephosphorylation with an unknown kinase.

```

reaction: Wee1p -> Wee1
reaction rate: (kwr*[Wee1p])/(Kmwr + [Wee1p]) nM/minute
parameters: kwr = 0.1 nM/minute
            Kmwr = 1 nM
species: Wee1p = 1 nM (inactive)
         Wee1 = 0 nM (active)

```

Reaction 40, Activation of Intermediate Enzyme by Active MPF

The inactive intermediate enzyme (IE) is activated by phosphorylation with active M-phase promoting factor (MPFp).

```

reaction: IE + (MPFp) -> IEp + (MPFp)
reaction rate: (kie*[MPFp]*[IE])/(Kmie + [IE])
parameters: kie = 0.02 1/minute
            Kmie = 0.01nM
species: IE = 1 nM (inactive)
         IEp = 0 nM (active)

```

Reaction 41, Deactivation of IE

The active intermediate enzyme (IE) is deactivated by dephosphorylation.

```

reaction: IEp -> IE
reaction rate: (kier*[IEp])/(Kmier + [IEp])
parameters: kier = 0.15 nM/minute
            Kmier = 0.01 nM
species: IE = 1 nM (inactive)
         IEp = 0 nM (active)

```

Reaction 42, APC Activation by IEp

Anaphase-promoting complex (APC) is activated by an active intermediate enzyme (IEp).

```

reaction: APCi + IEp -> APCa + IEp
reaction rate: (kap*[IEp]*[APCi])/(Kmap + [APCi])
parameters: kap = 0.13 1/minute
            Kmap = 0.01 nM
species : APCi = 1 nM
         APCa = 0 nM

```

Reaction 43, APC Deactivation

Anaphase-promoting complex (APC) is deactivated.

```

reaction: APCa -> APCi
reaction rate: (kapr*[APCa])/(Kmapr + [APCa])
parameters: kapr = 0.13 nM/minute
            Kmapr = 1 nM
species : APCi = 1 nM
         APCa = 0 nM

```

Block Diagram of the M-Phase Control Model with Reactions

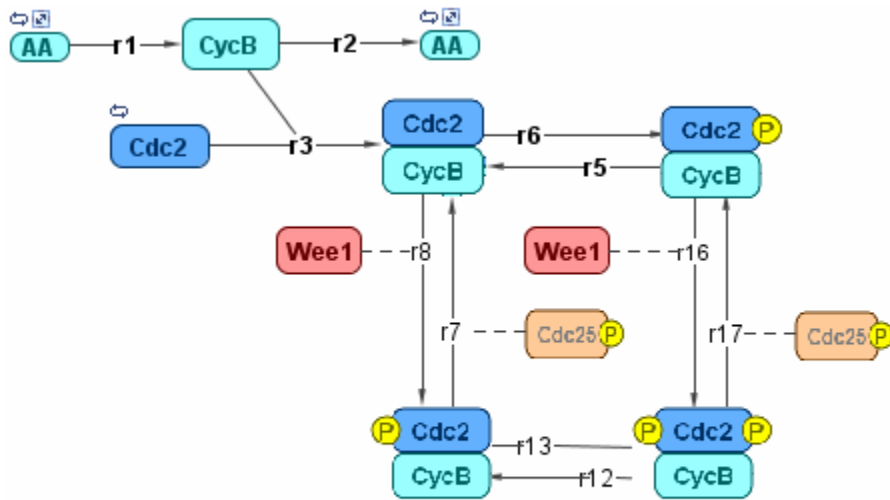

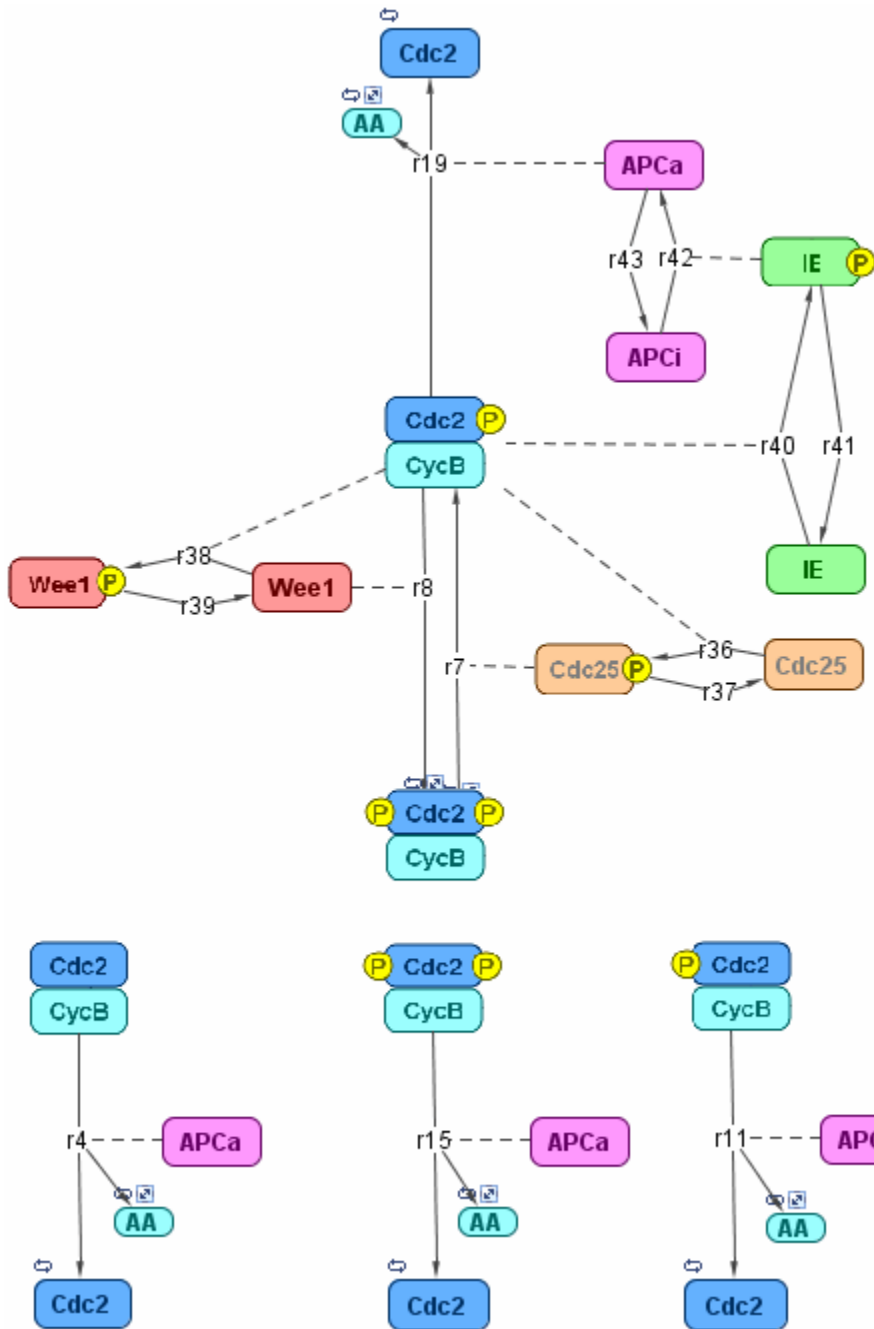

References

- [1] Borisuk M, Tyson J (1998), "Bifurcation analysis of a model of mitotic control in frog eggs," *Journal of Theoretical Biology*, 195(1):69-85, PubMed 9802951.
- [2] Marlovits G, Tyson C, Novak B, Tyson J (1998), "Modeling M-phase control in Xenopus oocyte extracts: the surveillance mechanism for unreplicated DNA," *Biophysical Chemistry*, 72(1-2):169-184, PubMed 9652093.

- [3] Novák B, Tyson J (1993), "Numerical analysis of a comprehensive model of M-phase control in *Xenopus* oocyte extracts and intact embryos," *Journal of Cell Science*, 106(4):1153-1168, PubMed 8126097.